

Grand Square

KEEPING THE SQUARE DANCE COMMUNITY INFORMED

NORTHERN NEW JERSEY SQUARE DANCERS ASSOCIATION

Vol. 52 - No. 1

Map Issue

Sept. 2009 - Jan. 2010

September Is National Square Dance Month!



Cover design by Bill Smythe of Bee Sharps
NNJSDA Poster Contest Winner for 2009

Grand Square

KEEPING THE SQUARE DANCE
COMMUNITY INFORMED

CO-EDITORS

Barbara & Norman A. Kanter

3461 Amboy Road, Apt. 4A
Staten Island, NY 10306

Tel/Fax: 718-351-9150

bnkanter@verizon.net

Jan & Louis Thompson

52 Redwood Lane

Freehold, NJ 07728-2962

732-577-9413 Fax: 732-577-9412

LTPT1@yahoo.com

Billing

Kay Davis

Production Staff

Rusty Ball Lise Greene

Proofreaders

Bernadette & Stan Bevan

Catherine & Jim Douglas

Georgi Flandera

Ruth Edison & Ron Kapnick

Published 3 Times a Dance Season

Print Circulation: 1,100

Online at: www.NNJSDA.org

Deadline	Due Out	Theme
July 7	Aug. 25	Maps/Classes
Nov. 7	Jan. 10	Winter/Spring
March 7	April 25	Grads/Summer

ADVERTISING RATES

Actual Size Necessary for Camera-Ready Ads*	Sent by Email	Sent by USPS
Full 4 $\frac{3}{4}$ " W x 7 $\frac{1}{2}$ " H	\$55	\$60
1/2 4 $\frac{3}{4}$ " W x 3 $\frac{3}{4}$ " H	30	35
1/4 4 $\frac{3}{4}$ " W x 1 $\frac{3}{4}$ " H	15	20
1/8 4 $\frac{3}{4}$ " W x 0.9" H	10	15

*Word, Excel, PowerPoint only.

Use largest type to fit size.

The following extra charges may apply:

Creating ad from hard copy	\$20
Corrections, sizing, etc.	5
Fee for billing	2

Payment Due With Ad

Make all checks payable to NNJSDA.

Subscriptions: \$12 for 3 issues

Send articles to Thompsons, ads to Kanter, and checks to NNJSDA Treasurer.

NNJSDA EXECUTIVE BOARD, 2009-2010

Executive Committee

President: Lise Greene
133 New Jersey Ave, Lake Hopatcong, NJ 07849
973-663-4396 lise.greene@montclair.edu
Ken Robinson
614 Van Liew Ct, Hillsborough, NJ 08844
908-963-2447 kenrbnsn@nnjsda.org
Email to both: president@nnjsda.org

Assistant Treasurer: Kay Davis
973-697-7765 kaydavis@optonline.net
Sigrid Eisele
973-627-1896 sige@pocketmail.com

Past President: Rusty & Richard Ball
973-838-0312 NJSquareDancers@verizon.net

1st Vice President: Donna Poyer
908-852-9285 donna_and_mike@comcast.net

Grand Square Editor: Jan & Louis Thompson
Barbara & Norman Kanter
See contact information above.

2nd Vice President: Audrey Kerner
201-612-0856 audrey.kerner@gmail.com

Advisor/Trustee: Georgi & Richard Flandera
973-427-2889 rgflandera@optonline.net
Donna Poyer & Mike Szekula
908-852-9285 donna-and-mike@comcast.net
Shirley & Dick White
603-532-7327 dswwhite84@myfairpoint.net

3rd Vice President: Jeanne Gannon
732-872-2377 jmg52@comcast.net

Recording Secretary: Judy & Al Kendziora
69 Myrtle Ave, Metuchen, NJ 08840
732-494-8871 ackendziora@verizon.net

CCNJ Liaison: Ruth Edison & Ron Kapnick
973-857-8879 kapnickrr@juno.com
Education/Gathering: Rusty Ball
973-838-0312 NJSquareDancers@verizon.net
Insurance: Mike Szekula
908-852-9285 donna_and_mike@comcast.net
NJ Incorporation Agent: Georgi Flandera
973-427-2889 rgflandera@optonline.net
Webmaster: Ken Robinson
908-963-2447 kenrbnsn@nnjsda.org

Corresponding Secretary: Greg Fokszye
13 Bond Pl, West Caldwell, NJ 07006-8106
973-403-1854 thegregster@verizon.net

Treasurer (Acting): Rusty Ball
52 Kiel Ave., Kinnelon, NJ 07405
973-838-0312 NJSquareDancers@verizon.net

From the computers of..... **Lise Greene & Ken Robinson, NNJSDA Co-Presidents**



We are happy to serve as Co-Presidents this year and look forward to meeting many of you at NNJSDA dances and at your own club dances. If you see us and we haven't met before, please introduce yourselves! You can send an email to both of us using this new address: **president@nnjsda.org**.

The Executive Committee and Coordinators met as an Executive Board on June 14 and August 9 to review the past year and make plans for an exciting new year. If you'd like to put a face to a name, check the photos on nnjsda.org (Contacts page). We feel privileged to work with such fine people who are donating their time to keep square dancing vibrant.

In these times of economic stress, we've arranged for a deep discount on square dance printing at any Office Depot. (See article on page 39.) Of course, the NNJSDA continues to offer its own "discount programs."

Freeloaders earn a *free ticket to an NNJSDA summer dance* by having the Treasurer sign a form at three of the summer dances and the Mini-Festival in a given year. The completed form is your free ticket to a dance the next summer.

Patrons earn a *free ticket to the Mini-Festival plus a dangle* by visiting 65% (14) of the other Member Clubs on a regular dance night and having an officer sign a form. There's no time limit on fulfilling the requirements OR on how many awards you can earn.

One Square is Fair earns an *NNJSDA dues reduction for your club of 50 cents per member* if you've had at least one square at seven or more NNJSDA events in one dance season. This year, the season runs from June 2009 through May 2010. Special note: Because the time frame for this program was changed, any summer 2009 NNJSDA dance at which your club had at least one square earned OSIF credit for both 2009 and 2010. Extra bonus: The NNJSDA Executive Board will "raid" every club that completed the 2009 OSIF program!

Continued on page 8

Northern New Jersey Square Dancers Association

Caller
Alternating MS/PL
Early Mainstream at 7:30

Mike Callahan (NY)

Round Dance Cuers

Tom Denniston/Ellen McCabe (NJ)

Dance Date/Time

Friday, October 30, 2009
8:00 – 10:30 pm



Location

St. Aloysius Church, Caldwell
Map on page 51

Inquiries

Donna Poyer & Mike Szekula
908-852-9285
Night of Dance: 908-619-2296

NNJSDA CALENDAR OF EVENTS

September

- 13 **Delegates Meeting** (1 pm)
YMCA, Springfield

October

- 30 **NNJSDA Dance** (MS/PL/RD)
St. Aloysius Church, Caldwell
Callahan/Denniston, McCabe

November

- 7 *Grand Square* Deadline
Winter/Spring Issue
- 8 **NNJSDA 35th Mini-Festival**
Bridgewater (tentative)
Biggerstaff, Franks, Gotta/Gotta
- 15 NNJSDA Exec. Board Meeting

January 2010

- 10 **Delegates Meeting** (12:30 pm)
VFW, Elmwood Park
Grand Square Distribution
NNJSDA Mid-Term Dance (3 pm)
VFW, Elmwood Park
Class Teachers
- 30 **NNJSDA Dance** (MS/PL/RD)
St. Aloysius Church, Caldwell
Reardon, Snyder/Booz

March

- 7 *Grand Square* Deadline
Summer Issue
- 14 NNJSDA Exec. Board Meeting

April

- 25 **Delegates Meeting** (1 pm)
VFW, Elmwood Park
Grand Square Distribution
NNJSDA Spring Fling (3 pm)
Landi
- 30 **NNJSDA Dance** (MS/PL/RD)
Mager/Booz (location TBA)

June

- 7 Questionnaire Deadline
- 13 NNJSDA Exec. Board Meeting
- 23-26 NSD Convention: Louisville, KY
- 30 **NNJSDA Dance** (MS/PL)
Jacobs

July

- 7 *Grand Square* Deadline
Map Issue
- 14 **NNJSDA Dance** (MS/PL)
Gotta
- 28 **NNJSDA Dance** (MS/PL)
Koft

August

- 8 NNJSDA Exec. Board Meeting
- 11 **NNJSDA Dance** (MS/PL)
Spencer
- 25 **NNJSDA Dance** (MS/PL)
Ritucci
Grand Square Distribution

Northern New Jersey Square Dancers Association

Caller
Alternating MS/PL
Early Mainstream at 7:30

Round Dance Cuer

Dance Date/Time

Location

Inquiries

**Dennis Reardon &
Jim Snyder (PA)**

Russ Booz (PA)

**Saturday, January 30, 2010
8:00 – 10:30 pm**

**St. Aloysius Church, Caldwell
Map on page 51**

Donna Poyer & Mike Szekula
908-852-9285
Night of Dance: 908-619-2296



TUMBLING LEAVES

19TH ANNUAL

FESTIVAL

OCTOBER 16, 17, 18 2009

BENNINGTON COLLEGE BENNINGTON, VERMONT

LARGER OUTSTANDING STAFF!!

- RED BATES
- BILL HARRISON
- TIM MARRINER
- JOHN MARSHALL
- DON MOGER
- KEN RITUCCI
- RALPH & JOAN COLLIPI
- STEVE & IRENE BRADT

**- NOW OFFERING -
A FULL
MAINSTREAM HALL!**



FIVE HALLS
THE ENTIRE FESTIVAL
PLUS, A1, A2, C1(Limited C2)
NEW - MAINSTREAM !!

- Round Dance Workshops
- Varied Packages Available
- Square Dance Shop
- RV Space on campus
- Campground nearby

**CONTACT INFORMATION:
RED BATES**

Nov-May: 5134 Latham Ter
Port Charlotte, FL 33981
941-828-0481

Jun-Oct: PO Box 1197
Rangeley, ME 04970
207-864-2524

E-MAIL: redbates@juno.com

2009-2010 BASIC/ MAINSTREAM CLASSES

Listed by: day of week; alphabetically by hall location; club name; open house date and time; class starting date and time (all PM); hall name and address; T = Teacher; CC = Class Coordinator's name, address, phone number, and e-mail; TBA = To Be Announced. Changes may occur, so call to confirm starting dates and halls. Please notify the Editors of any corrections.

SUNDAY

North Brunswick – **Rutgers Promenaders** – Open House: Oct. 4, 1:30; Classes start: Oct. 18, 1:30; American Legion Post 459, 1015 Linwood Place, 08902; T = Betsy Gotta/Dan Koft; CC = Ken Robinson, 908-963-2447, kenrbnsn@rutgerspromenaders.org

MONDAY

Bridgewater – **Bee Sharps** – Open House: Sept. 14, 7:30; Classes start: Oct. 21, 7:30; Adamsville School, 400 Union Ave. (Rt. 28), 08807; T = Gardner Patton; CC = Diana & Bob Cole, 980-874-8117, dianakcole2000@yahoo.com

Paramus – **Circle Eights** – Open House: Sept. 14, 21, 7:30; Classes start: Oct. 5, 7:30; East Brook Jr. H.S., 190 Spring Valley Rd., 07652; T = Andy Woerner; CC = Gerry Beatty & Rick Savino, 201-358-1138, GPB64@aol.com; Tom & Joan DeAngelis, 201-568-7155, joandeangelis@yahoo.com

Towaco – **Lakeland Squares** – Open House: Oct. 5, 12, 7:30; Classes start: Oct. 19, 7:30; Church of the Transfiguration, 9 Two Bridges Rd., 07082; T = Fran Wadel; CC = Eb & Judi Nordman, 973-334-5122; Kathy Keener, 973-366-8064, lakelandsquares@hotmail.com

TUESDAY

Caldwell – **Cross Trail Squares** – Open House: Sept. 17, 7:00; Classes start: Sept. 10, 7:00; Grover Cleveland M.S., Academy Rd., 07006; T = Ron Kapnick; CC = Steve Frank, 973-731-1249, snf1956@aol.com

Clark – **Y Squares** – Open House: Sept. 15, 7:30; Classes start: Sept. 22, 7:30; Hehnly School, 590 Raritan Rd. 07066; T = Dan Koft; CC = George Kuhne, 732-548-8537, gkuhne@optonline.net

Leonardo – **Middletown Ramblers** – Open House: Sept. 27, 7:30; Henry Hudson Trail Center, Rt. 36, 07216; T = Larry Sherwood, ljsheerwood@att.net; CC = Betty Scharmann, 732-291-1188, bscharmann@comcast.net

Newton – **Kittatinny Rangers** – Classes start: Sept.15, 7:30; Halsted Middle School, 59 Halsted St., 07860; T = Wayne Applegate; CC = Stan Tyburski, 973-383-2933, georgiaandstan@embarqmail.com

WEDNESDAY

Brooklyn, NY – **AleMo Squares** – Open House: Sept. 16, 7:00; Classes start: Sept. 23, 7:00; Our Lady of Grace Church, 430 Ave. W, 11223; T = Don Coy; CC = Caroline Parlato, 718-745-3793, nodyoc@aol.com

Nanuet, NY – **RocklandRockytops** – Classes start: Oct. 7, 6:45; Nanuet High School, 101 Church St., 10954; T = Fran Wadel; CC = Patsy Lisak, 845-639-6816, jlisak9845@aol.com

THURSDAY

Glen Rock – **Belles & Beaux** – Open House: Sept. 3, 7:30; Classes start: Sept. 10, 7:30; Glen Rock Central School, 600 Maple Ave., 07452; T = Fran Wadel; CC = Marie Broughel, 201-857-2690, mbroughel@yahoo.com

Staten Island, NY – **AleMo Squares West** – Classes start: Sept. 10, 7:30; Eger Health Care Center, 16 Meisner Ave., 10306; T = Barbara Kanter; CC = Norman Kanter, 718-351-9150, bnkanter@verizon.net

Plus/ Advanced Classes on page 8



Where Fun
Meets
Friendship

CROSS TRAIL SQUARES

2ND & 4TH Wednesdays 8:00 – 10:00

Plus Workshop 7:30 - 8:00

After Tip 10:00 - 10:15

Grover Cleveland Middle School
88 Academy Road (@ Prospect St)
Caldwell, NJ 07006

(One block off Bloomfield Ave)

INFO: **Ron Kapnick** 973 857-8879
Dan Tapper 973 228-3177
At the hall 973 420-7149

FORMAT: ALTERNATING MAINSTREAM AND PLUS

Sept 9	Don Coy	Back to School Night
Sept 23	Mike Jacobs	Take Me Out to the Ball Game
Oct. 14	Nick Martellacci	Men in Aprons ⊗
Oct. 28	Jim Snyder	Monster Mash ⊗ Halloween Bash
Nov. 11	Ed Foote	Turkey Shoot ⊗
Nov 25	No Dance - Happy Thanksgiving	
Dec. 9	Joe Landi	Holly Jolly Holiday
Dec 23	No Dance - Happy Holidays	
Jan. 13	Betsy Gotta	Caribbean Night
Jan. 27	Nick Martellacci	Can Can Dance (donations)
Feb. 10	Dan Koft	Valentine Dance

⊗ Contests

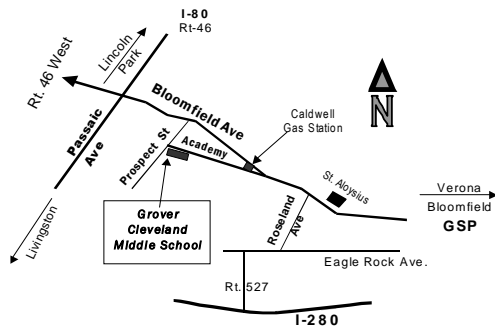

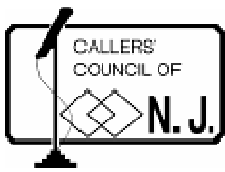

The CCNJ has been moving and grooving. Some of our members attended and/or called at the 58th National Square Dance Convention in Long Beach, CA. Roy and I took part in the competition dancing (just for fun) in what came to be called the “callers’ square.”

The CCNJ has a new website at the same address, ccnjcallers.com. Listed along with our former members, you will see new members who are graduates of our callers’ class. The Council held three dances this past spring to give the new callers the opportunity to practice calling to real dancers. They have made lots of progress, and I know you will be hearing from them in the future.

The CCNJ will be holding its Mid-Winter Mania dance for class dancers in February 2010. Look for flyers, or print one from our website. If you are interested in what callers talk about, come to a meeting. The education session starts at 9:30 am. We meet four times a year on the second Saturday of September, December, March, and June. Check our website for location and directions.

Betsy Gotta (ugottadance@optonline.net)

732-249-2086

Classes Continued from page 6

2009-2010 PLUS/ ADVANCED CLASSES

Brooklyn, NY – AleMo Squares – Plus classes start: Sept. 23, 8:30; see Wednesday Basics listing for details.

Oradell – Western Wheelers – APD Plus classes start: Sept. 15; T = Andy Woerner, 201-261-1047 for details

Advanced classes start: September 17; T = Andy Woerner, 201-261-1047 for details.

Randolph – Reelers – Plus classes start: Sept. 15, 7:30; Ironia Elem. School, 303 Dover-Chester Rd. (Rt. 513), 07869; T = Fran Wadel; CC = Bonnie & Charlie Van Stone, 908-832-5313, rms.373@hotmail.com

Presidents’ Letter continued from page 3

Raiders earn *another 50 cents off each club member’s NNJSDA dues* by having at least one square attend dances at other Member Clubs in one dance season (June 2009 through May 2010). Points are awarded based on the distance between clubs. Once you’ve reached 200 points, you’re done – and you’ve all had fun while saving your club some dues dollars the following year.

All these incentives are geared toward helping clubs stay healthy. Can you think of a better way than square dancing to enjoy life, get exercise, travel, meet happy people, munch on delicious treats, and make good friends? We can’t! So encourage your friends to take lessons at a club near them – the more the merrier.

We are planning a dinner meeting for club presidents in February to express appreciation for their selfless work and to share ideas. Details will be sent later.

Finally, please read Jan Thompson’s article on page 21 about the NNJSDA dance format. We truly want to know the preferences of our dancers with regard to program and format, and have designed the sign-in sheet to collect your input.

The NNJSDA is here to serve you. **Suggestions and comments** are always welcome. You can send an email message to suggestions@nnjsda.org, drop a note in the Suggestion Box that will be at all Association dances, or use the electronic Suggestion Box on the website.

Lise Greene and Ken Robinson, NNJSDA Co-Presidents

Rutgers Promenaders

2009 – 2010 Dance Season
1st and 3rd Sunday Afternoons
September 20th through June 6th
2:30 – 5:00 PM
American Legion Post 459
1015 Linwood Place
North Brunswick, NJ 08902
Family Friendly
Mainstream Dancing For All Ages

Callers: **Betsy Gotta**
and/or **Dan Koft**

Cuers: **Roy Gotta**
and/or **Kathy Koft**

Watch for information about our
Toys for Tots Dance in December

For more information:
Ken Robinson

908-963-2447 (cell phone)
kenrbnsn@rutgerspromenaders.org
www.rutgerspromenaders.org

Northern New Jersey Square Dancers Association

Student Mid-Term Dance **Callers: Class Teachers**

Come support our newest dancers!

Dance Date/Time **Sunday, January 10, 2010**
3:00 pm (after Delegates Meeting)

Location **VFW, Elmwood Park**
Map on page 53

Inquiries **Audrey Kerner 646-275-4970**
Cell for Day of Dance: same as above



35th ANNUAL
MINI-FESTIVAL
SUNDAY, NOVEMBER 8, 2009
See page 33 for details.

[This is part of the series of articles highlighting people active in the NNJSDA.]

Dot and Don Coy



Don Coy comes from a musical family and has been “picking and grinning since he was knee high to a grasshopper.” In the mid 1960s, he traveled through Kentucky and Indiana with his band, The Rhythm Makers, and recorded two country songs: “I’m Gonna Be a Guitar Player Someday” and “So Lonely.” Through the Triangle Talent Agency, he kept busy entertaining at conventions held in Louisville.

He started square dancing in 1972 and attended his first caller-training class in 1974. Don was the featured caller for five Kentucky square dance clubs and very active in the local callers’ association, serving in every office.

Dot learned square dancing from her mother, who taught it at Fort Hamilton High School in Brooklyn. As a young adult, she had a lot of fun in the Poconos at the “Darktown Strutters Ball” called by a man named Curly. In 1984, she took additional lessons from Bill Anderson.

When Dot attended the National Square Dance Convention in 1986, she caught Don’s eye. “It was love at first dosado,” said Don. “My pick-up line was: Do you dance Plus?”

Over the next few years, Don and Dot won a few awards – “frequent flyer, that is.” So in September 1990, Don moved from Louisville to Brooklyn to marry Dot. “We survived very well on Kentucky Fried Chicken and a Big Apple,” he quipped.

Don has a degree in recreation education, though his day job was department manager for Sears. Dot earned a degree in elementary education and taught first grade in the New York school system for 35 years. After taking early retirement in 1995, Dot turned her talents to teaching line dancing. The Coys often team up with square and line dancing at local clubs, and they teach dance classes at Kingsborough Community College in Brooklyn.

They also entertain at parties in the New York City area and teach at various children’s events. With Dot’s educational background, said Don, “she really shines when we’re doing a dance for a hundred anxious children, because she knows how to make them pay attention.”

The Coys’ memorable dance experiences include calling and dancing at the Statue of Liberty, on top of Cadillac Mountain in Maine at sunrise, and on a glacier in Canada. Don is a member of CALLERLAB and the Callers’ Council of New Jersey, where he serves as treasurer. He is club caller for AleMo Squares in Brooklyn and Pelham Promenaders in Pelham, instructor of an Advanced workshop on Staten Island, and guest caller for clubs throughout the region. He has recorded several songs for Red Boot Star, Lore, TNT, and Coyote Records, and was featured on a New York State Lottery commercial.

Dot is a Yankees fan while Don roots for the Mets, but they share many other interests such as camping, kayaking, biking, traveling, and listening to audiobooks in the car. Don has two sons, Dot has two daughters, and together they have seven grandchildren.

Adapted from the Coys’ website (www.dotanddoncoy.com) by Lise Greene



Square D Fashions

Sacramento, CA
916-207-6101 / 877-502-8317 (toll-free)
e-Mail: squareDfashions@comcast.net

***No dance apparel store in your area?
We are just a phone call away!!***

Check out our web site to view some of our creative and unique **dance clothing and accessories for guys, gals, and kids, too.** We carry traditional and/or modern styles for **all tastes, from the fanciest frills to the basics.** We've been providing specialty clothing to dancers for over **26 years and know what you like.**

www.SquareDFashions.com

Live(liest) Music Dance

The music was both live and lively at NNJSDA's last dance of the season on Saturday, May 30. Don Coy called to the accompaniment of the Blue Harvest Band, which consists of four instrumentalists and a singer.

The dance floor at the YMCA/Chisholm Community Center in Springfield was packed with 124 dancers. Between tips, round dancers enjoyed Mary McGee's cueing.

During the announcement break, outgoing NNJSDA Presidents Rusty and Richard Ball presented Patron dangles to Peter and Sylvia Collette, who graduated from Cross Trail Squares in 2006. In addition to the dangles, they will receive free ribbons to the Mini-Festival.

The Balls also introduced members of the incoming Executive Board. Then, on behalf of the Association, 1st Vice President Donna Poyer presented Rusty and Richard with an engraved clock as an expression of appreciation for their tireless leadership during the past two years.

Lise Greene



Chuck & Gerry Hardy



Square Dance Callers

**Now booking dates
for 2009 and 2010**

cdhardy@aol.com

gerhardy@aol.com

www.chuckandgerry.com

PO Box 88

Underhill, VT 05489

802-899-9925 800-584-3453 cell 914-388-4693



Don't Be Out of the Loop!

Keep up-to-date on square dance events and programs by adding your email address to the NNJSDA Info-List.

Go to nnjsda.org and click on "Sign Up," or send an email to:
webmaster@nnjsda.org

(Remember: If you sign up to receive,
you can also send YOUR square dance news to the site.)

Tenakill Twirlers

Bryan School—Cresskill, N.J. 07626

51 Brookside Ave.

3rd Fri.—Mainstream with 1 Plus tip—8:00-10:30

2009

Oct. 16 --- Roy Leber

Nov. 20 --- Dan Koft

Dec. 18 --- Wayne Applegate

2010

Jan. 15 --- Howard Richman

Feb. 19 --- Dan Koft

Mar. 19 --- Roy Leber

Apr. 16 --- Don Coy

May 21 --- Howard Richman

Pres. Gloria Fodera---V.P. George/Fanny Meyer

201-385-8869 201-385-3263

www.sqrdance.org/Tenakill.Twirlers

Attending NNJSDA Dances – “A Treat”

Put on your dancing shoes and attend an NNJSDA dance! It is surely a treat you will enjoy. During the few years we have been square dancing, we have attended a number of NNJSDA dances and found them thoroughly enjoyable and challenging. There is dancing for everyone: Mainstream, Plus, rounds, and an “A” tip at the end of the evening. Having the opportunity to dance with those who are more experienced has made us better dancers (we hope), and as we have gained experience, we have been able to help others who recently graduated. It has been at these dances that we have become acquainted with members from various clubs within our Association. It is amazing how many new friendships can develop on the square dance floor! These friendships will encourage you to explore the other clubs within the NNJSDA.

We have been able to dance close to home to some great callers, some who are local and some who call nationally. While some of these evenings have been challenging, at the end of the night, we can truly say it has been a great experience.

The venue is always conveniently located and easily accessible, and the halls are conducive to comfortable spacious dancing. We are fortunate to have this forum, provided by the NNJSDA, to enjoy the “spirit” of our activity. Support our Association – Come to the dances and have a ball!

Peter & Sylvia Collette (Cross Trail Squares)



Middletown Ramblers

7:30-10:00 pm, Fridays
 Croydon Hall, 900 Leonardville Ave.,
 Leonardo, NJ 07733

Sept. 11	Clay Goss	Oct. 30	Howard Richman
Sept. 18	Dan Koft	Nov. 6	Wayne Applegate
Sept. 25	Don Coy	Nov. 13	Doug Kaufmann
Oct. 2	Joe Landi	Nov. 20	Ed Foote *
Oct. 9	Jeremy Butler *	Dec. 4	Joe Landi
Oct. 16	Jim Snyder	Dec. 11	Glenn Matthew
Oct. 23	Don Coy	Dec. 18	Mark Franks **

Directions: GSP South to Exit 117. Rt. 36 approx. 8 miles to Academy Bus Depot. Turn right on Hosford Ave. (light) and cross Leonardville Road (stop sign). Make next left onto Bryant Avenue, which ends in the Croydon Hall complex. Dance hall is the last building on the right.

September 25 Open house – Open to public, Thompson Park, Lincroft
September 29 Classes start at Henry Hudson Trail Activity Center,
 Avenue D & Route 36, Atlantic Highlands

**** December 18** Holiday Covered Dish – If you are coming, bring your favorite dish. Please call to let us know so we can plan for seating.

Plus Club + Rounds

COST: Members \$3.00; Guests \$4.00 (refreshments are served)
 * \$5.00 (National Caller)

NOTE: Hearing enhancement system available.

Ken Douglas, 732.581.4361 Jeanne Gannon, 732.500.6939
 Betty Scharmman, 732.291.1188

www.middletownramblers.org

MOUNTAIN SQUARES

Joe Landi, Caller – A2 (Workshop as needed)

1st and 3rd Wednesdays

7:45 - 10:00 pm

Our Lady of Mercy Parish Center

90 Whippany Road at Eden Lane

Sept. 16th - Dec., March - June;

3rd light off Rt. 10

Information: Groth 973-746-0656

Roome 973-543-4109

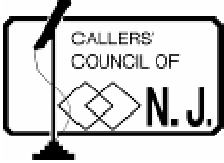

CCNJ Supports New Dancer Recruiting

Recruiting new members is one of the most critical factors in the survival of all organized recreational activities. All of us should be actively recruiting for our club's fall classes. The CCNJ and the NNJSDA want to see each club have a successful class. To that end, the CCNJ will do all that it can to supply callers for any club's efforts to recruit new dancers. If your club arranges a demo or presentation of any sort and you need a caller, please feel free to contact a CCNJ officer. We will do our best to supply a caller for your event.

We all know that every club needs more New and Younger Dancers if they are to survive. Let's all think creatively, roll up our sleeves, and fill up those classes. If each club could recruit two squares for each of the next two years, we would double the number of dancers in Northern New Jersey. Wouldn't that be fantastic!

Ron Kapnick, President (KapnickRR@juno.com) 973-857-8879

Read Kathy Keener's article "Pay It Forward" on page 40.

CONGRATULATIONS, RAIDERS!

Nine clubs completed the raid program in 2008-2009.

We congratulate and thank them all for helping to keep our area clubs healthy and FUN to dance at.

**BEE SHARPS
CROSS TRAILS
REELERS**

**BELLES & BEAUX
LAKELAND SQUARES
WESTERN WHEELERS**

**CIRCLE EIGHTS
MOUNTAIN SQUARES
Y SQUARES**

Here's to an even longer list for 2009-2010.

Raid and you might be raided in return.

RocklandRockytops

PLUS		MAINSTREAM	
First Friday - 8:00 to 10:15 PM (Third Friday in July & August)		Second Friday - 8:00 to 10:15 PM	
DBD Workshop - 7:45 to 8:00 PM		DBD Workshop - 7:45 to 8:00 PM	
A-1 Aftertip - 10:15 to 10:30 PM		Plus Aftertip - 10:15 to 10:30 PM	
		Except Sept when there is a Public Introductory (ABC) Dance From 7:30 to 8:30 PM.	
<i>No Dance</i>		09/11/09	Howard Richman *
10/02/09	Mark Franks	10/09/09	Sandy Corey
11/06/09	Ken Ritucci	11/13/09	Ed Foote
12/04/09	Howard Richman	12/11/09	<i>Betsy Gotta - FREE DANCE</i>
01/01/10	Roy Leber	01/08/10	Todd Fellego
02/05/10	Betsy Gotta	02/12/10	<i>Fran Wadel, Student Dance</i>
03/05/10	Mark Franks	03/12/10	Roy Leber
<i>Good Friday, No Dance</i>		04/09/10	Nick Martellacci
05/07/10	Rick Gittelman	05/14/10	Sandy Corey
06/04/10	Don Coy	06/11/10	Howard Richman
07/16/10	Ken Ritucci	07/09/10	Chuck & Gerry Hardy
08/20/10	Roy Leber	08/13/10	Bruce McCue

*For Sept, Special Intro (ABC) Dance from 7:30 to 8:30 PM. Regular MS dance 8:30 to 10:30 PM (no Plus Aftertip). Angels are encouraged to attend the Introductory Dances.

Location: The Air Conditioned West Nyack Firehouse, 42 Strawtown Road, West Nyack, New York 10994

Singles Welcome

From New York State Thruway:

Take Exit 13S to Palisades Interstate Parkway. Go ½ mile to Exit 8E (Route 59 East). *(follow instructions below for Palisades Interstate Parkway)*

From Palisades Interstate Parkway:

Take Exit 8E (Route 59 East). Continue on Route 59 to first traffic light. Turn left onto Crosfield Avenue. Continue to end of Crosfield Avenue, turn right onto West Nyack Road and continue to traffic light. Turn left onto Strawtown Road. Firehouse is just past yellow blinker on the right.

From Kinderkamack Road (NJ):

Kinderkamack Road becomes Route 304 in New York. Follow Route 304 north to Route 59 (East). Turn onto Route 59 East. *(follow instructions above for Palisades Interstate Parkway)*

For further information:

David & Miriam: 845-354-6351

Mal & Dotty: 845-638-4393

Various Sun.

Sept-June

Kathy Colucci: 718-375-1788

Our Lady of Grace Church

430 Ave. W at E. 4th St, 11223

Cell for dance night: 917-699-2039

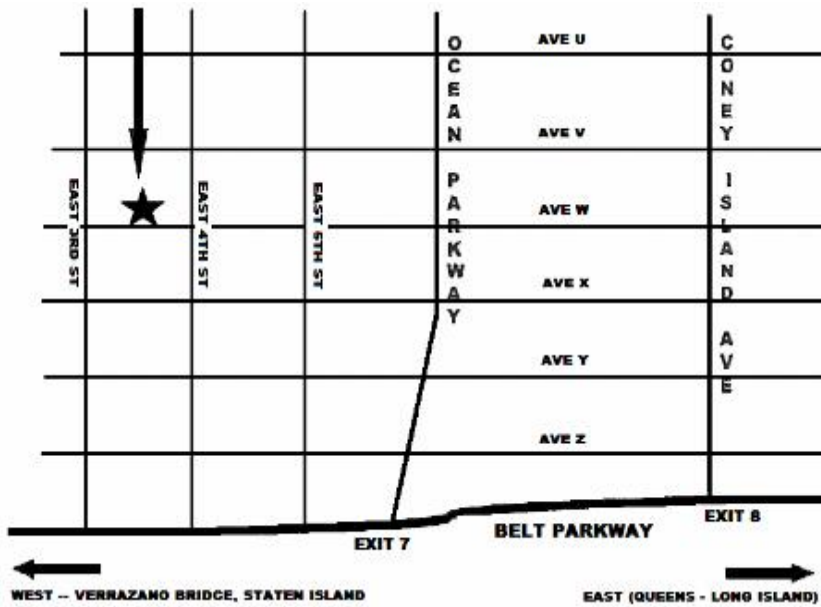

AleMo might not have had any scheduled dances over the summer, but that doesn't mean they weren't dancing. Members participated in two demos on Staten Island, one in the Bronx, and the annual visit to Abraham House, a nursing home in Brooklyn. Club teacher Don Coy, along with his wife, Dot, called for all four demos.

In addition, recent graduates Ernest Park, Janet Kvalheim, and Alice Walsh traveled to Staten Island to participate in the ABC Dances held there. The callers for those dances were Paul Ingis, Barbara Kanter, and Dan Tapper, all new callers who benefited from the caller classes held by the CCNJ. The number of new dancers each night kept growing, and we hope to see a full class for AleMo West start in September.

Sunday dances in Brooklyn will start again in September. Come on over! Allow some time before the dance for a visit to the Coney Island Aquarium or a great shore dinner. After all, we cross the bridges to New Jersey all the time. Let's reverse the flow.

(Written by Barbara Kanter, guest reporter, while Walter was on vacation.)

Ad on page 42

Walter Lasky (bklynadv@aol.com)

718-996-5848

35th ANNUAL

MINI-FESTIVAL

SUNDAY, NOVEMBER 8, 2009

See page 33 for details.



**Garden State Square Dance
Campers Association**



Dinner Dance
Sunday, December 6, 2009

11:00 AM to 4 PM
Caller: Howard Williamson
Cuer: Donna Williamson

Full Course Dinner: Roast Beef, Chicken,
Birch Beer, Wine, and Beer.
\$40 per person
NO Door Prizes!
Guests Welcome

The
Brownstone House
351 W. Broadway
Paterson, NJ
Phone: 973-595-8582

Directions

Route 46 East to Union Boulevard; North/Totowa/ Paterson (go under overpass) Take Union Boulevard until it dead ends at W. Broadway (2.8 mi); turn left on W.Broadway. Pass one blinker to traffic signal (about 4 blocks). Immediately beyond traffic signal, Brownstone is on left.

Route 80 West to Exit 55B (Totowa/Union Blvd.) Proceed as above.

Route 80 East to Exit 54 (Totowa / Union Blvd).At end of ramp turn left; proceed as above

Make checks in the amount of \$80 per couple (\$40 single) payable to GSSDCA and mail to:

Inars & Jeanne Gruntals, 5 Valley Way, Mendham, NJ 07945-1761

Reservations must be returned to the Gruntals by November 24, 2009

Name _____

Address _____

City _____ State _____ Zip+4 _____

Phone Number (including area code) _____

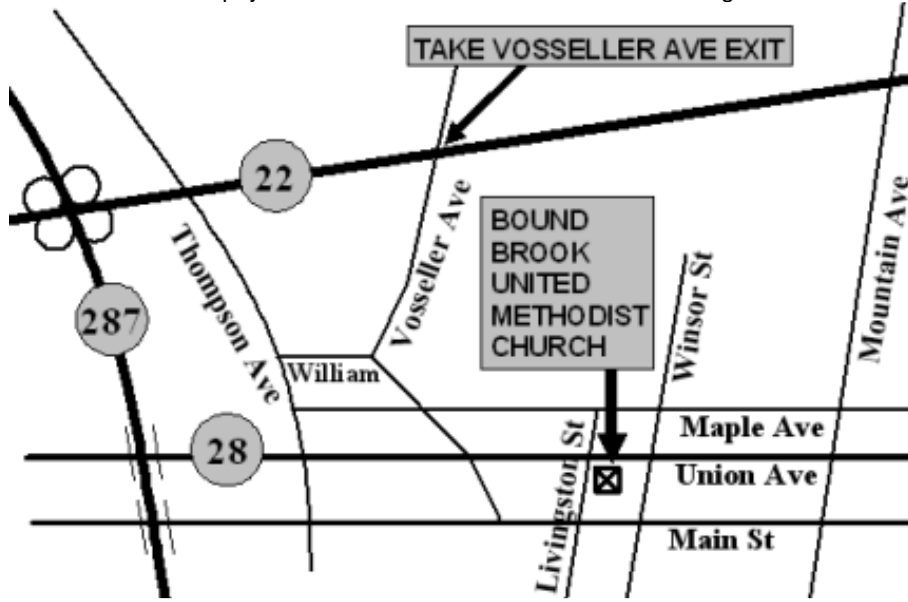

We will be dancing alternating Mainstream/Plus from September through May this season. In June, we graduated three Mainstream dancers and the Flutterwheels had a large Mainstream graduating class. We want to give them lots of opportunity to dance with us. If you know anyone who wants to learn how to square dance, send them (or better yet, bring them) to our open house on September 14. This year, we will sponsor a beginner's class finishing Mainstream in January, followed by a Plus class graduating in June. For the last two years, we experimented with running two classes each Monday night with beginners starting in September or in January. Since this did not attract more students, we are going back to the old class format.

Ad on page 33 Diana & Bob Cole (dianakcole2000@yahoo.com) 908-874-8117

Thank You, NNJSDA Host Clubs
Delegates Meeting - Sept. 13: Middletown Ramblers
NNJSDA Dance - Oct. 30:
Spinning Wheels, Tenakill Twirlers, Western Wheelers

NNJSDA New Dance Format: Is It Working For You?

Article on page 21: Let your voice be heard!



CIRCLE EIGHTS

2009 - 2010

Mainstream Dances



Sept 25	Nick Martellacci	Feb 26	Jim Snyder
Oct 23	Dennis Reardon	March 26	Joe Landi
Nov 27	Howard Richman	April 23	Andy Woerner
December	See below	May 28	Betsy Gotta
Jan 22	Ken Ritucci	June 25	Manny Amor

Dances: 4th Friday of each month from 8 – 10:30 pm
(No dances in July and August)

First Congregational United Church of Christ
276 Haworth Ave, Haworth, NJ 07641
Plus Workshop 8 – 8:15 Plus tip 9:15

For information: Eric or Ginny Mailman 201-599-9412
For directions: call cell 201-788-9320



December 31, 2009 NEW YEAR'S EVE DINNER & SQUARE DANCE

GLENN MATTHEW (DE) calling - 2MS/1PL

*Reformed Church of Oradell, NJ
641 Church Street (at Kinderkamack Road)
7:30 to after midnight - \$30 per person
Single dancers welcome
See our flier for more information*

Co-sponsored by Circle Eights and Western Wheelers



BELLES & BEAUX – Glen Rock

MS-PL tip

www.sqrdance.org/BellesBeaux

1 & 3 Wed. Sept-May

Central School, 600 S. Maple Ave., Glen Rock

1 & 3 Wed. June-Aug

VFW Hall, 6 Veterans Pl., Elmwood Park, 07407

Audrey Kerner: 646-275-4970

Cell for dance night: 646-275-4970

For map for summer dances, see page 53.

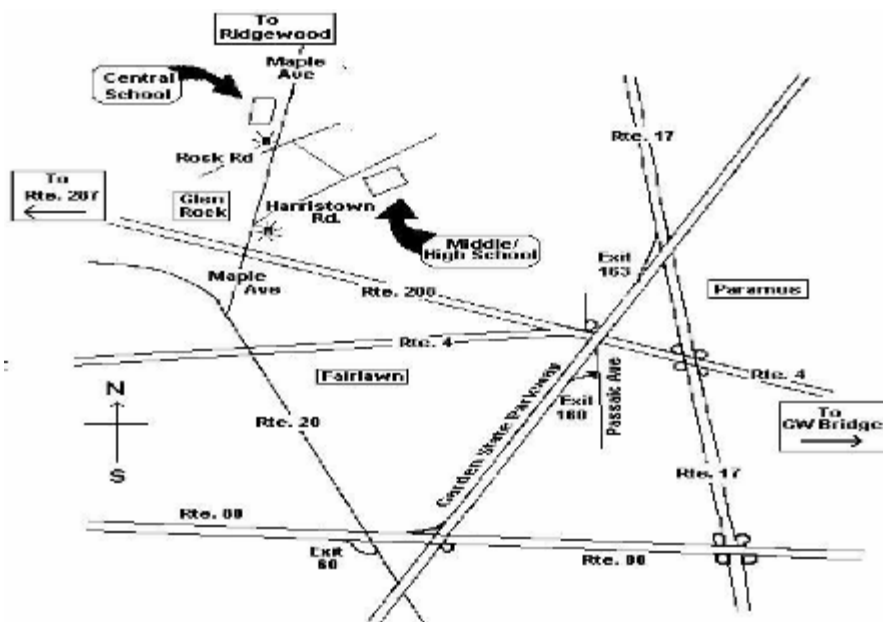

The **BIG NEWS** from Belles & Beaux is that from now on our dances will be starting earlier. **Dances will be starting at 7:30** instead of 8:00 pm so you can all get home and get your beauty sleep. We will still be dancing the first and third Wednesdays of the month.

Our Mystery Bus Raid was a smashing success, as usual. This year we went Down the Shore to Tuckerton Seaport, where we raided the Pine Square Campers. The group danced on the shells that cover all the surfaces at the seaport in place of gravel, and the dancers received danglers in the shape of the seaport logo. Larry Kanniard and Joe Landi were the callers, with John Toll cueing the rounds. Pine Squares President Katie Crowley and her board cooked a great “campfire” supper, and raid organizer Rusty Ball said the participants “thoroughly enjoyed the dancing, the cuisine, and the company.”

The Pine Squares were camped out at Holly Acres in Egg Harbor City, as were members of the Garden State Campers. Rusty said the visit was a surprise to the NNJSDA campers who were there, as they were not let in on the mystery until Friday night in order to maintain the club’s “disguise.”

We have 10 new dancers from Fran Wadel’s Mainstream class. We hope they will enjoy dancing with us.

The door is always open in Glen Rock. Join us!

Ad on page 62

Jim Berrie (kwberrie@msn.com)

201-262-5871



REELERS

Ironia School, 303 Dover-Chester Road
(Route 513), Randolph 07869

1st and 3rd Fridays

7:30–Early Rounds

8:00–Plus/Rounds

Info: Presidents Linda & Rick Murphy 973-539-9315

<u>Date</u>	<u>Caller</u>	<u>Cuer</u>	<u>Theme</u>
09/18/09	Fran Wadel	Mary Pickett	Back to School Night
10/02/09	Glenn Matthew	Mary Pickett	Autumn Colors
10/16/09	Dennis Reardon	Mary Pickett	Hawaiian Night
11/06/09*	Mark Franks	Mary Pickett	Red, White, and Blue
11/20/09	Joe Landi	Karen Kushla	Thanksgiving Food Drive
12/04/09	Len Anfinsen	Mary Pickett	Gold Rush
12/18/09	Mike Jacobs	Mary Pickett	Cookie Night
01/15/10	Jim Snyder	Mary Pickett	Book Swap
02/05/10	Roy Leber	Mary Pickett	Chocolate Delight
02/19/10	Dennis Reardon	Mary Pickett	Pie and Presidents Night

* Alternate location to be announced

Class Information: Bonnie and Charlie Van Stone, 908-832-5313

Plus: Fran Wadel – Tuesdays, 7:30, Ironia School

Round Dance: Mary Pickett – Mondays, 7:30 and 9:00, Morris Plains, 862-209-1254

NNJSDA New Dance Format: Is It Working For You?

Much thought and debate went into changing the dance format used at NNJSDA dances to the one presently in use (Early Mainstream 7:30-8:00, Alternating Mainstream and Plus 8:00-10:30 with two rounds cued in between tips, all singers Mainstream, Advanced star tip if there are sufficient dancers). Last season and this season are a **trial period** after which the Executive Board will evaluate the new format to see if it is best serving the needs of the dancers in our Association. How will the Board determine this?

Our attendance sheet at the NNJSDA dances has been revised. In addition to dancer's name and club, there are columns for the program danced: Mainstream, Plus, Other, and Rounds. It is **VERY IMPORTANT** that **all** dancers check off the square dance program(s) they **prefer** to dance and whether they dance rounds. Please take a moment to complete the information on the line by your name when you sign in.

In addition, there will now be a **Suggestion Box** at the treasurer's table at Association dances, as well as on the NNJSDA.org website. The Board sincerely encourages dancers to submit their thoughts about the current NNJSDA dance format and any other ideas they have to assist the Board in fulfilling their dancing needs. If you are no longer attending the NNJSDA dances, **let the Board know why**.

All the information and feedback the Executive Board collects is valuable. They want to hear from **YOU** in order to provide an enjoyable and satisfying dance experience for the most Association dancers. **Let your voice be heard!**

Jan Thompson

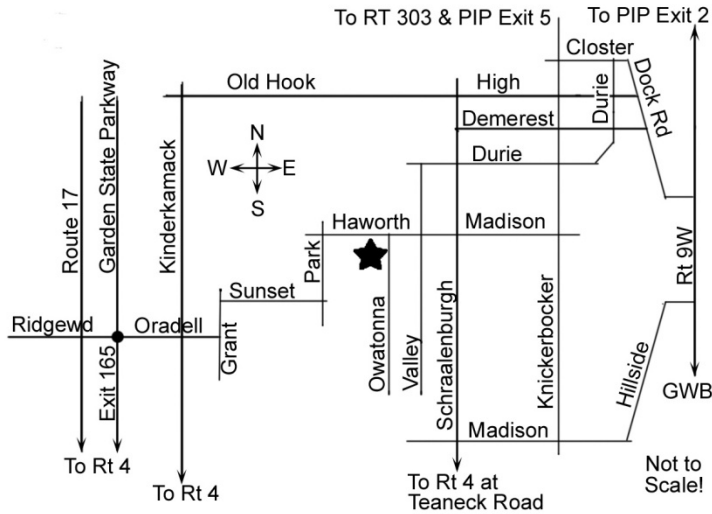

Circle Eights danced up a storm in March with three full squares raiding RocklandRockytops, and the club hosted nine squares at our special Student Dance. During that evening of fun, lucky Dave Gurowsky of Rockland Rockytops won our Joker Jackpot in the amazing amount of \$448. Circle Eights will be starting a new Joker Jackpot in September, so be sure to visit and try your luck.

In April, Circle Eights welcomed our 12 new graduates with a dinner party and the gift of free club membership for the rest of the season. We were fortunate to have two callers at our April club dance. Andy Woerner was the main caller and Paul Ingis, who has completed his CCNJ lessons, called “between the tips.”

Our May potluck dinner was a culinary delight for all attendees. In June, our ice cream social was raided by Belles & Beaux. Eight squares danced to the exciting calls of Nick Martellacci. The make-your-own sundaes cooled down that hot June night.

We ended the year by awarding Addie Johnson and Lorraine Albrecht “Members of the Year” for all their service as our Refreshment Chairmen. If you’ve attended our dances, you know what delectable treats they provide between tips. As a thank you, they will both be receiving free admission to the Circle Eights dances in the upcoming season.

Circle Eights completed the ’08-’09 raid year with well over 200 mileage points. We began the new raid year by raiding Rutgers Promenaders, which automatically gives us 50 points, a quarter of the 200 point goal. Having lunch at Chili’s before the raid added to the dancers’ enjoyment of the day.

Eric and Ginny Mailman are our new “fearless leaders.” Looking ahead, plan to ring in 2010 at the Circle Eights/Western Wheelers’ New Year’s Eve Dance.

Ad on page 19 Jeanne Weissman (Kreider99@aol.com) 201-722-0488

Y Squares

NEW FORMAT: Alt. MS/PL & RDS 1 Teach
2nd & 4th Fridays Rounds @ 7:30 Squares @ 8:00
Hehnly School: 590 Raritan Road, Clark, NJ 07066
Zion Lutheran Church: 559 Raritan Road, Clark (alt. site)

<u>Date</u>	<u>Theme</u>	<u>Caller</u>	<u>Cuer</u>
Sept. 11	Welcome Back	Koft	Koft
Sept. 15	Open House	Koft	
Sept. 25	Apple Fest	Franks	Kushla
Oct. 9	Columbus Day	Koft	Koft
Oct. 23	Halloween	Ritucci	Kushla
Nov. 13	Thanksgiving (Food Bank)	H & D Williamson	
Dec. 11	Holiday (Bring a Toy)	Reardon	McCabe
Dec. 25	Christmas	No Dance	
Jan. 8	BARN DANCE (Bring a Friend)	Koft	Koft
Jan. 22	Casual Friday	Koft	Koft

Contact: Jan & Paul Sanderson 908-233-2414
Cell for Night of Dance: 908-612-6677

Hunterdon Stars and Mercer ArcAngels at the National Square Dance Convention



On the road again! The Hunterdon Stars and Mercer ArcAngels Handicapable Square Dance Clubs have returned from the National Square Dance Convention in Long Beach, CA. They had a wonderful time watching a show at the opening of the convention, dancing, putting on exhibitions, and so much more.

Continued on page 28

CROSS TRAIL SQUARES – Caldwell

MS/PL

www.crosstrailsquares.org

2 & 4 Wed. Sept-June

Grover Cleveland Middle School, 36 Academy Rd., 07006

Ron Kapnick & Ruth Edison: 973-857-8879

Cell for dance night: 973-420-7149

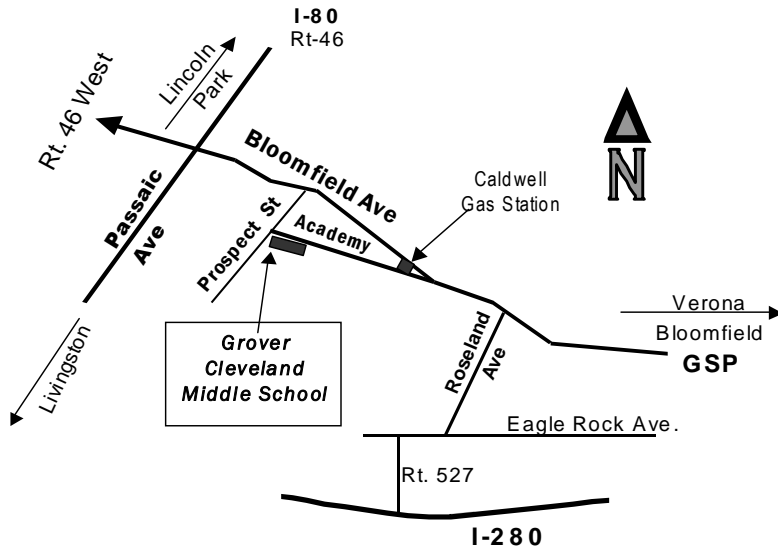

Cross Trail Squares held its annual dinner dance in March – 41 years and going strong! An enthusiastic group of 74 dancers enjoyed a wonderful afternoon of dancing. Howard Williamson, who is always fun to watch and fun to dance to, was our caller. The event was so well received that we have already booked Howard for 2010.

We were delighted to have seven new dancers graduate in May. Ron Kapnick, our club caller/instructor and new president, called the dance as we welcomed the graduates into our ranks. Club member Dan Tapper, a “caller-in-training,” called several singing calls during the evening. Our hats are off to Ron, Ruthie, and the many angels who gave their time week after week to help the new dancers along. Most of the graduates attended the NNJSDA’s Spring Fling in April.

We wrapped up our dance season in June with our annual ice cream social. Many gallons of ice cream and a variety of toppings were consumed that evening. Dancing to the always-enjoyable Jim Snyder was the cherry on top!

We have already completed two raids for the 2009-2010 season. We have an annual tradition of raiding Hix & Chix in June, and as usual, the antics of callers Tom Miller and Bill Harrison were a treat for our 20 raiders.

We received great reports from the three Cross Trail Squares couples who attended the National Convention: Ron Kapnick and Ruth Edison, Billy Flynn and Alice DeLancey, and Pete and Sylvia Collette.

We are happy to announce our own “stimulus plan” for the economy and square dancing: Our fall new dancer class, which starts on September 29, will be FREE for the 12-week session! Check our website for details and other club news. Hope to see you in a square!

Ads on pages 7, 55 Doris Fera & Charles Krueser (Dor915@optonline.net) 973-887-3455

LAKELAND S



AIR CONDITIONED HALL

SENIOR HOUSE, 356 ROUTE 202 (MAIN ROAD), MONTVILLE, NJ 07045
(Just off Route 287 Exit 47)

TUESDAYS 7:45 to 10:15 PM *Alternating MAINSTREAM & PLUS*
September through July *with 2nd tip PLUS DBD workshop*
5th Tues: Barn Dances (8:00 PM)

September 2009

1 NO DANCE
8 NO DANCE – *Labor Day*
15 Derek Page
22 Manny Amor
29 Barn Dance - Howard Richman
Open to the public - Bring your friends!

October 2009

6 Roy Leber
13 Gardner Patton
20 Don Coy
27 Dennis Reardon

November 2009

3 NO DANCE – *Election Day!*
10 Ed Foote
17 Nick Martellacci
24 Dan Koft

December 2009

1 Howard Richman
8 Fran Wadel – *Student Dance*
15 Jim Snyder – *Holiday Dance*
22 NO DANCE – *Happy Holidays!*
29 NO DANCE – *Happy New Year!*

January 2010

5 Roy Leber
12 Gardner Patton
19 Nick Martellacci
26 Manny Amor

February 2010

2 Roy Leber
9 Fran Wadel
16 Manny Amor
23 Nick Martellacci

E-mail us at:

Lakelandsquares@hotmail.com or
Lakeland@squaredancing.com



For Information:

Kathy Keener: 973- 366-8064 Sig: 973-627-1896

Visit our Website at www.squaredancing.com/lakeland

F.A.D. SQUARES – Paramus

MS-PL tip

1 & 3 Sun. All Year

St. Matthew's Church, 167 Spring Valley Rd., 07652

Chris O'Connor: 201-797-6145

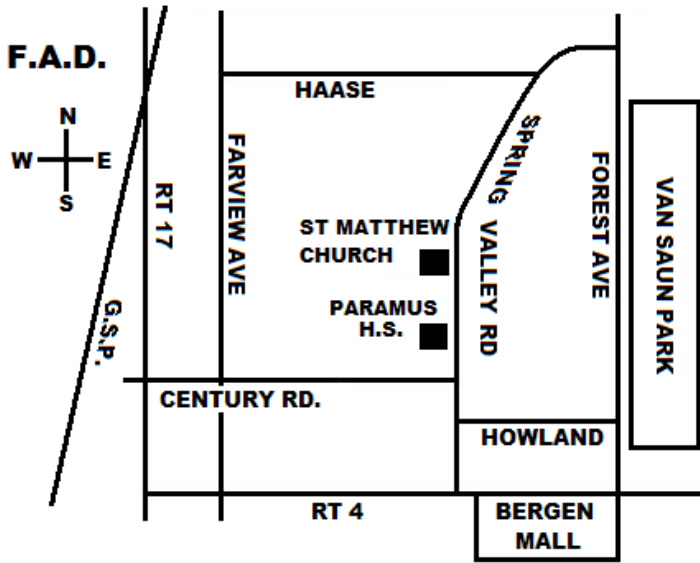

F.A.D., “Fun at Dancing,” has been having just that – lots of fun, mainly because so many clubs have been raiding us and also so many individual dancers have been visiting us. “The more the merrier” is really true. The increased attendance is also helping F.A.D. financially, which is great.

Speaking of finances, we are very proud of our wonderful new treasurers, Jim VanRensalier and Carol Freemyer. We hope they will stay with us for a long time. We appreciate their volunteering their services. We will miss our outgoing treasurers, Dick and Brenda Dexter, who did a fabulous job for many, many years. We hope they will visit with us often in the future. Thank you both.

We have a great lineup of callers and of course delicious food, all homemade by our president, Chris O’Connor.

So come one, come all, and be prepared to have **FUN!**

Ad on page 30

Doris Wilson

201-845-8294

FIVE CLUBS – Springfield

1 & 3 Sat. June-Aug

Vic & Nancy Ammons: 908-369-3418

2 MS/1 PL/RD

YMCA Chisholm Community Center

100 S. Springfield Ave. & Shunpike, 07081

Cell for dance night: 908-763-0050

For map, see page 51.

Ad on page 61

Spinning Wheels

**WE DANCE MAINSTREAM EVERY MONDAY NIGHT
SEPTEMBER through JUNE**

Air Conditioned Valley Middle School, 71 Oak Street, Oakland, NJ 07436

**INTRODUCTION TO PLUS – 8:00-8:30 pm
Refreshments provided by Members**

**ONE TIP – PLUS
WESTERN DANCING WITH DOLORES**

.....

Sept. 14, 2009	Roy Leber
21	Wayne Applegate
28	NO DANCE—YOM KIPPUR
Oct. 5, 2009	Don Coy
12	Roy Leber
19	Jim Snyder
26	Howard Richman
Nov. 2, 2009	Gerry Hardy
9	Ed Foote
16	Wayne Applegate
23	Chuck Hardy
30	Roy Leber
Dec. 7, 2009	Don Coy
14	Howard Richman
21	Chuck & Gerry Hardy
28	NO DANCE—HOLIDAY
Jan. 4, 2010	Jim Snyder
11	Roy Leber
18	NO DANCE—MARTIN LUTHER KING
25	Howard Richman

INTRODUCTION TO PLUS offers all square dancers the opportunity to learn the CALLERLAB Plus Program from many callers. One Plus figure is reviewed from the previous week and one new figure is introduced.

SPINNING WHEELS SQUARE DANCE CLUB A GREAT PLACE TO DANCE

For information call: Dolores Gesumaria 201-741-1154

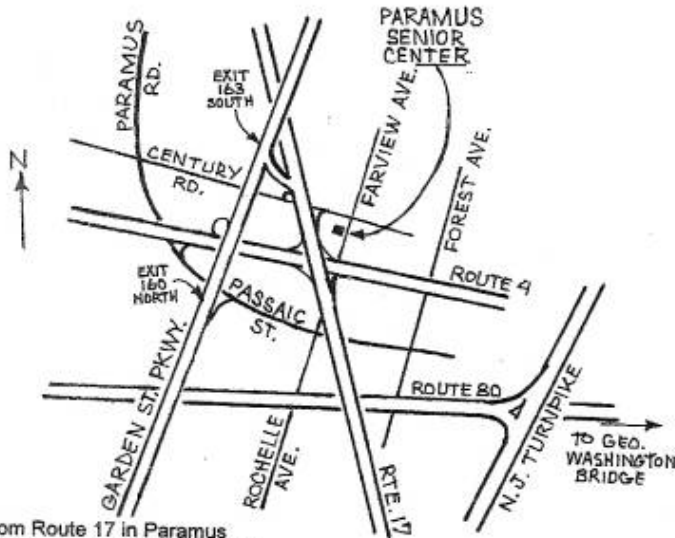

Directions: From Route 17 in Paramus turn east on Century Road to the first traffic light; turn right onto Farview Avenue and go about 100 yards.- Senior Center is on the right - parking in back

Ad on page 47

HIX & CHIX – Elmwood Park

PL/RD-A tip

www.hixchix.nnjsda.org

Various Thurs. June-Aug

VFW Hall, 6 Veterans Pl., 07407

Connie & John Huettemann: 201-438-0948

Hall Phone: 201-791-0765

For map for summer dances, see page 53.

Hunterdon Stars & Mercer ArcAngels continued from page 23

There were approximately 100 dancers whooping it up in the Handicapable Hall. The Hunterdon Stars and Mercer ArcAngels did an awesome job with all of their exhibitions! We also enjoyed dancing to a wonderful line-up of callers from various states as well as England. The Handicapable Hall was the place to be!!

The Hunterdon Stars and Mercer ArcAngels have been traveling since 1997. They attend at least one convention every year, either a National or Handicapable Convention, and sometimes they attend both. Many of the dancers save their money all year to attend the conventions. We also fundraise through "Adopt-A-Dancer." This program has helped us keep the cost of the trips more reasonable. If you are interested in making a donation, you may send it to: Hunterdon Stars and Mercer ArcAngels, 36 Brampton Place, Gansevoort, NY 12831.

Michelle Mabie

[**Editors' Note:** New Jersey was very well represented on the exhibition floor.]

Western Wheelers

Rounds Teach - 7:30 pm; Plus & Rounds - 8:00-10:30 pm; "A" tip - 10:30 pm

Club Cuer - Peg Millar

Sept. 26 **Mike Jacobs**

Oct. 24 **Dennis Reardon**

Nov. 28 **Joe Landi**

Oct. 10 **Jim Snyder**

Nov. 14 **Len Anfinson**

Dec. 12 **Jim Snyder**

December 31, 2009 New Year's Eve

Join us for: Fun, Food, and Friendship at our NYE Gala
with **Glenn Matthew**

Co-sponsored by Circle 8's

Jan. 9 **Betsy & Roy Gotta**

Feb. 13 **Andy Woerner**

Mar. 11 **Howard & Donna Williamson**

Apr. 10 **Howard & Donna Williamson**

Jan. 23 **Wayne Applegate**

Feb. 27 **Dan & Kathy Koft**

Mar. 27 **Glenn Matthew**

Apr. 24 **Don Coy**

Come and Dance with Western Wheelers 2nd & 4th Saturdays

Info: Roger 201-384-0334 or Bob 201-664-4348

The Reformed Church of Oradell, 641 Church St., Oradell, NJ 07649

Visit us at: sqrdance.org/Western.Wheelers

Event Announcement Email List: How to Subscribe & Use **Squaredance_info@nnjsda.org**

FAST and FREE for announcing information of interest to square dancers: publicity, reminders, and announcements of last minute changes in schedules or locations. Once a subscriber, you can receive and send to the list. Questions? Contact Ken Robinson.

To get on the list (subscribe)

- Go to NNJSDA.org, click on "Sign up for the NNJSDA Event Announcement Email List," and fill out the form (name, email, phone, and club).
- **OR:** Send an email to Ken (kenrbnsn@nnjsda.org), with name, phone, and club.
- Respond to email asking you to confirm subscription request – no confirmation, no subscription.

To receive and send messages

- Address email to: squaredance_info@nnjsda.org.
- Include clear title in subject line so readers can determine message's relevance.
- Compose text as you would any other email message. Keep it simple!

35th ANNUAL

MINI-FESTIVAL

SUNDAY, NOVEMBER 8, 2009

See page 33 for details.

F.A.D. SQUARES

MAINSTREAM WITH PLUS TIP

1st and 3rd Sundays 7:30 – 9:30 pm

September 6	Mickey McFarland
September 20	Roy Leber
October 4	Nick Martellacci
October 18	Don Coy
November 1	Gerry Hardy
November 15	Ed Foote
December 6	Dan Koft
December 20	Jim Snyder
January 3	Howard Richman
January 17	Nick Martellacci
“Fun At Dancing”	

ST. MATTHEW’S CHURCH
167 SPRING VALLEY RD.
PARAMUS, NJ 07652

CHRIS O’CONNOR
201-797-6145
DICK & BRENDA DEXTER
201-529-3372

Hand Washing for Health

Hand washing can be the single most effective thing you can do to protect yourself and those around you from illness. When done correctly, hand washing can reduce the spread of infectious disease.

Here are some “tips” to follow when you wash your hands between dance tips, before going to the refreshment table, and after bathroom breaks.

- Wet your hands with WARM running water.
- Add soap, then rub your hands together, making a soapy lather. Do this away from the running water for at least 20 seconds. Do not wash the lather away.
- Remember to wash your thumbs, between fingers, under nails, and the front and back of your hands.
- Rinse your hands well under the warm running water. Let the water run back into the sink, not down to your elbows.
- Dry hands thoroughly with paper towels.
- Turn off the water with a clean paper towel.

What about **hand sanitizers**? Apply about a teaspoon of the alcohol gel on your palm. Then distribute over both hands, making sure to rub the front, back, and fingernails. Let the alcohol dry, which should take about 30 seconds.

Helen Jacobson RN (Reelers)



BEE SHARPS OF SOMERVILLE

Early Rounds 7:30 PM
MS/PL Dancing and Rounds 8:00-10:30 PM
Advanced tip at end of dance
if Advanced dancers are present.

OPEN HOUSE: September 14 from 7:30-9:30 PM at
Adamsville School
400 Union Avenue, Bridgewater, NJ 08807

DATE	CALLER	CUER	
Sept. 11	Mark Franks	Steve Bradt	MS/PL
Sept. 25	Howard Richman	Mary McGee	MS/PL
Oct. 9	Jim Snyder	Tom Denniston & Ellen McCabe	MS/PL
Oct. 23	Betsy Gotta	Roy Gotta	MS/PL
Nov. 13	Dan Koft	Kathy Koft	MS/PL
Nov. 27	No Dance		
Dec. 11	TBA	Steve Bradt	MS/PL
Dec. 25	No Dance		
Jan. 8, 2010	Howard Richman	Mary Pickett	MS/PL
Jan. 22	Jim Snyder	Karen Kushla	MS/PL
Feb. 12	Todd Fellegly	Steve Bradt	Alternating PL/A
Feb. 26	Mark Franks	Tom Denniston & Ellen McCabe	MS/PL

Contacts: Vic & Nancy Ammons (908) 763-0050

Where: Bound Brook United Methodist Church
150 Union Avenue, Bound Brook, NJ
Hall Phone (732) 356-1372

Directions:

From Route 22: Take Vosseller Ave exit to Bound Brook; left at light on Route 28. *Follow 2/10 mile to Livingston Ave. Make right onto Livingston and left into first driveway/church parking lot.

From Route 287 South: Take exit 13 for Route 28 Bound Brook/Somerville. Turn left at light for Route 28 East. Proceed through 4 lights. After the 4th light (follow from * above).

From Route 287 North: Take exit 13A for Route 28 East, Bound Brook. Proceed through 3 lights. After the 3rd light (follow from * above).

Visit us at www.squaredancing.com/beesharps

Map to the Mini-Festival

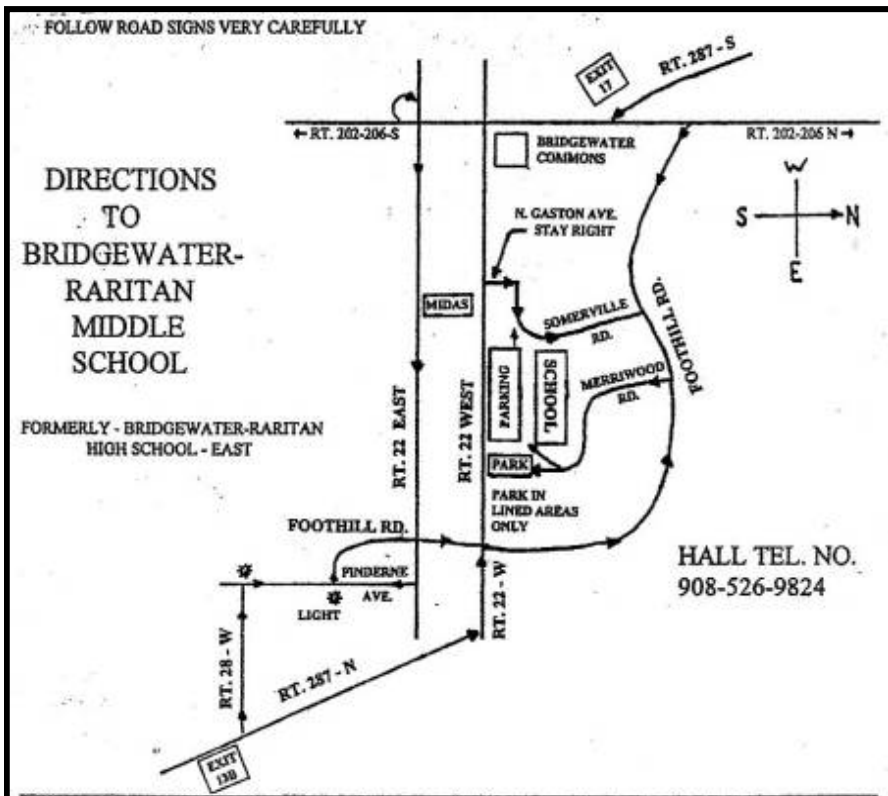

FROM Rt. 80 EAST OR WEST

Rt. 80 to Rt 287 South to Rt. 202-206 South (Exit 17) to Rt 22 East. Proceed 2 1/2 miles to Finderne Ave./Manville Sign. Turn right on Finderne Ave., pass light, and turn right onto Foothill Rd. Proceed 1.1 miles (you will go over Route 22) to Merriwood Rd. Make a left onto Merriwood Rd. Proceed into school driveway. Drive around school to side and front parking lots. No parking at yellow curbs. Park in lined areas only.

FROM RT. 78 EAST OR WEST

Rt. 78 TO Rt. 287 South to Rt. 202-206 South and follow above directions.

FROM RT. 287 NORTH

Rt. 287 North to Exit-13B (Route. 28 West). Go two (2) traffic lights and make a right onto Finderne Ave. At the next traffic light make a left onto Foothill Road. Proceed 1.1 miles (you will go over Route 22) to Merriwood Road. Make a left onto Merriwood Rd. Proceed into school driveway and drive around school to side and front parking lots. No parking at yellow curbs. Park in lined areas only.

**NORTHERN NEW JERSEY SQUARE
DANCERS ASSOCIATION**

35th ANNUAL



MINI-FESTIVAL

SUNDAY, NOVEMBER 8, 2009

2:00 - 9:00 pm

Tentative Location: Bridgewater-Raritan Middle School
Merriwood Drive, Bridgewater, NJ 08807

Jerry Biggerstaff

North Carolina

Betsy Gotta

New Jersey

Mark Franks

New Jersey

Rounds by:

Roy Gotta

New Jersey



Star Promenade – Square Dance Shop from Virginia

**** **3 Halls – MS, Plus, Advanced** ****

Dinner Hour: ½ hour C1 and Rounds by Request

Bring box supper or eat out / No cooking or warming devices

“ONE SQUARE IS FAIR” EVENT

Info: Rusty & Richard Ball 973-838-0312 Kay Davis 973-697-7765
Cell for Day of Festival 973-725-9738 or 973-725-9737

LIGHT Soft Soled Shoes ONLY – NO Boots Allowed

For latest updates and directions: www.NNJSDA.org

Mail to: Kay Davis, 23 Woodland Drive, Oak Ridge, NJ 07438

Name(s) _____ Club _____

Single – Would like a dance partner (prefer to dance Mainstream, Plus, or Advanced – circle one)

Street Address _____

State _____ Zip _____ Phone _____ Email _____

Advance Remittance \$15.00 each (\$18 at the door) _____ \$ _____

1st Time Badge \$ 2.75 each _____ \$ _____

2009 Bar \$ 1.00 each _____ \$ _____

TOTAL _____ \$ _____

PLEASE!!

Enclose a #10 SASE

with your order.

Thank you.

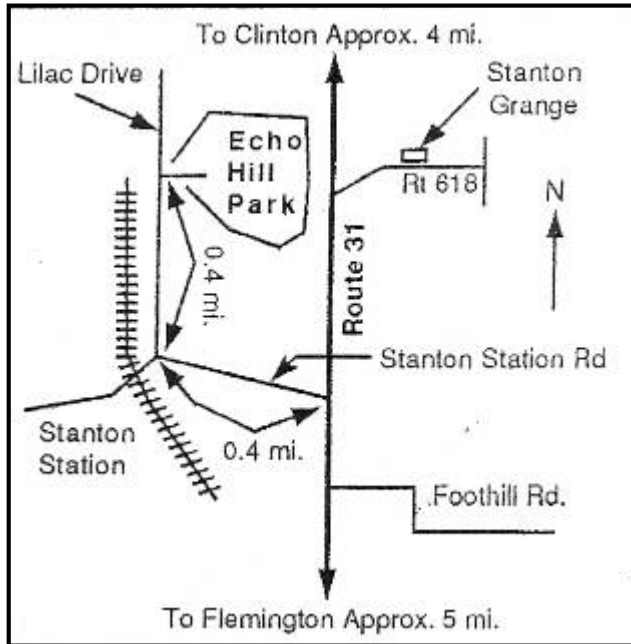

Congratulations to our Mainstream class, which graduated 18 new dancers in May. With the help of our angels, the class danced five squares for 10 Sundays. Thanks for everyone’s interest. What a thrill to share the joy of square dancing with so many people!

July and August saw many of our members again volunteering to help the Hunterdon County Park System with the “Music Under the Stars” program. We also enjoyed a summer picnic at the home of Peg and Fred Bailey. The combination of good friends and good food was a real winner.

On July 25, the Flutterwheels and the Bee Sharps hosted a Mainstream dance for their newly graduated classes and all dancers. The club teachers, Ed Kerns and Gardner Patton, put on a great show, and a good time was had by all.

It is a challenge to keep dancing during the summer, but the reward is great for those who are able to manage it. Pat and Don Elliott once again attended the National Convention. Many of our members visited other clubs that dance in air conditioned comfort; however, we are always glad to get back to our regular dance schedule.

Hope you can join us this coming dance season for fun and frivolity

Ad on page 49

Peg Bailey (pegfredb@comcast.net)

908-574-5095



Welcome in 2010

with

Will Larsen & Ken Ritucci

calling **A2** with **C1** star tips

Social Hour 6 - 7 pm

Catered Buffet Dinner 7 - 8 pm

DANCING: 8 pm - Midnight

THE DESSERT BREAK "TO DIE FOR"

\$50 per person



*Russian Orthodox Church, Sand Creek Road
Colonie, NY (Albany Area)*

***** SPACE LIMITED TO 10 Computerized SQUARES *****

Contact: Ken Ritucci: 413-734-0591, kenritucci@aol.com

Hotel Accommodations have been reserved at the **Hampton Inn** on Wolf Road at a special rate of \$94 per night for the New Year's Eve Dance.

For room reservations, call **518-438-2822** and tell them you are with the

"Acey Deuceys New Year's Eve Dance."

Send check for full amount for the dance, payable to Ken Ritucci,
to 132 Autumn Road, West Springfield, MA 01089.

Directions will be sent when registration is received.

Name(s) _____

Phone _____ Email _____

Address _____

City _____ State _____ Zip Code _____

Enclosed is the payment of \$_____ at \$50 each for ___ people.

I understand there will be **no refunds after December 1, 2009.**

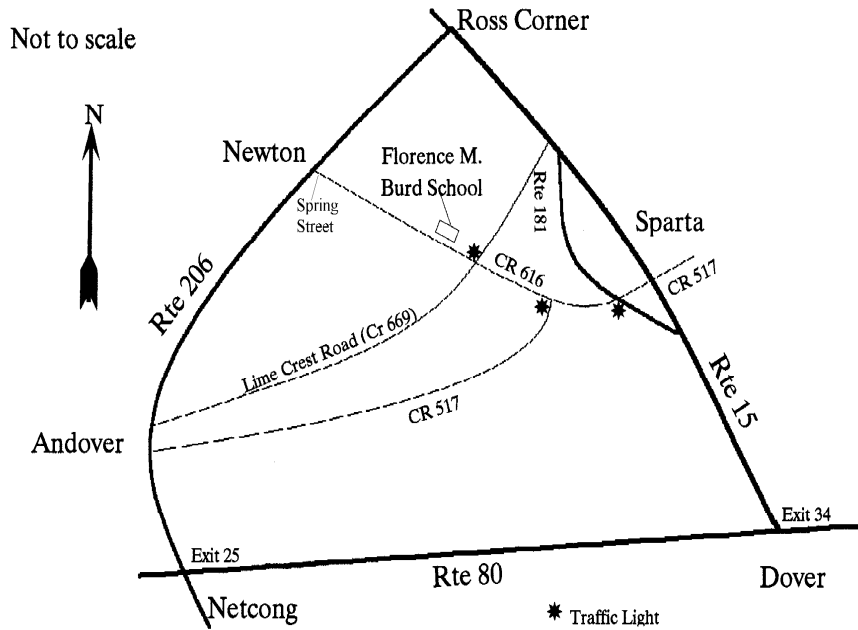

In April, Kittatinny Rangers held a charming graduation ceremony for nine new dancers. We wholeheartedly welcome our new square. A few newer dancers will be joining us in September.

In May, we had fun at our ice cream social and at our potluck supper. Before the supper, we held our annual meeting and recruited many of our new members to serve as “presidents-in-training,” “treasurers-in-training,” or some other office. The desserts were awesome! Since the school where we dance isn’t air conditioned, caller Fran Wadel took us outside to dance.

During the summer, Wayne Applegate called two dances for us under the stars at Lord’s Oasis in Budd Lake. Both were preceded by potluck suppers. In August, we had a club picnic at Lake Hopatcong.

We also put on some demos at the Sussex County Farm and Horse Show/New Jersey State Fair. We had fun, and it was nice to show people that this is not the square dancing they were forced to do in high school!

Ad on page 39 Ed & Rosemary Hoffmann (hoffmannrosemary@yahoo.com) 973-300-5325

RED BATES A-2 WEEKEND AT ROCKY'S!!

BOONVILLE, NY



SEPTEMBER 11-13, 2009

\$60.00 per couple

(camp fee not included)

*CASUAL
DRESS!

*C-1
SESSIONS!

*POT LUCK
DINNER!

SCHEDULE

FRIDAY

7:00-7:30 C-1 TIPS

7:30-10:00 A-2 DANCE

SATURDAY

10:00-12:00 A2 WORKSHOP

12:00-1:30 LUNCH

1:30-3:00 A-2 WORKSHOP

3:00-4:00 C-1 DANCE

5:00 POT LUCK DINNER

7:30-10:00 A-2 DANCE

SUNDAY

9:30-11:00 FAREWELL DANCE

Dance information: Red Bates 941-223-0987/redbates@juno.com

Camp information: Doris Lyon 315-942-2250/5142

Motel information: Headwaters Motor Lodge 315-942-4493 (mention Rocky's for a discount)

A-2 WEEKEND AT ROCKY'S - SEPTEMBER 11-13, 2009

SEND TO: RED BATES, 5134 Latham Terrace, Port Charlotte, FL 33981

Names _____ email _____

Address _____

City _____ State _____ Zip _____ Phone _____

LAKELAND SQUARES – Montville

MS/PL

www.squaredancing.com/lakeland

MS/PL 1, 2, 3, 4 Tues. Sept-July

Senior House

Barn Dance 5 Tues. Sept-July

356 Rt. 202 (Main Rd.), 07045

Kathy Keener: 973-366-8064

Cell for dance night: 973-229-0698

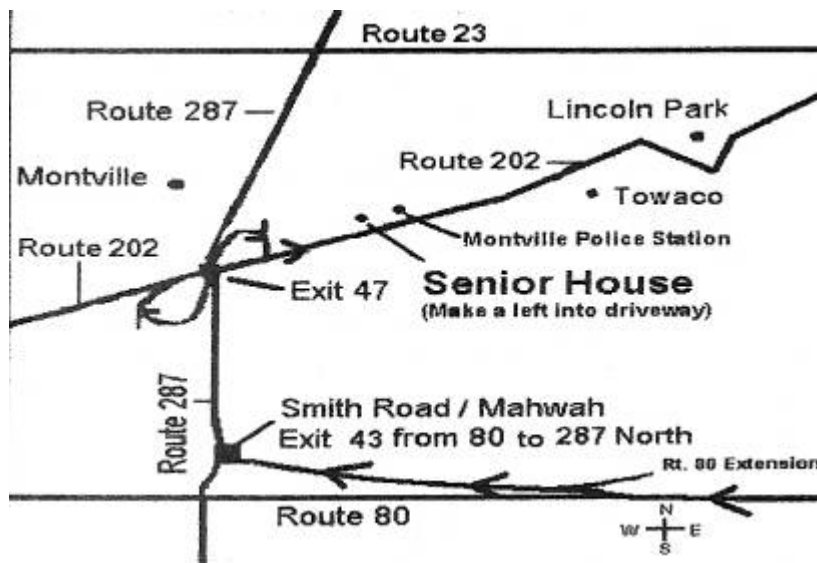

The majority of the members of Lakeland Squares are experienced Plus dancers who are enjoying our recent switch to Mainstream/Plus. However, we were concerned about the amount of floor time Mainstream dancers were getting with this program switch, so starting in the spring we gave them an extended opportunity to dance more Mainstream at every dance. Paul Ingis, a new caller, has been calling Mainstream between all our tips, so Mainstream dancers get to dance almost twice as much as before and can rest during the Plus tips. Paul does a fabulous job. Plus dancers get to dance as much Plus as they would at any Mainstream/Plus club. If they choose to dance every Mainstream and Plus tip and Paul's tips as well, they could conceivably be dancing nonstop, if they have the stamina. Starting in September, Paul will be calling "between tips" once a month; the exact dates will be publicized using the NNJSDA email announcement list.

Since we had no Mainstream classes this past season, Fran Wadel taught two series of Plus DBD classes. We welcomed dancers from several other clubs to these sessions. We all realized that these lessons helped us to become better all around dancers, and we had a ball. If there are enough experienced Plus dancers at our dances, we will make the last Plus tip a DBD workshop. If most of the Plus dancers are recent graduates, we will not have a DBD Plus workshop, as we do not recommend trying DBD until dancers have some experience.

Prospects look good for a Mainstream class this fall.

(This article was written by Kathy Keener. Jim & Catherine are still traveling.)

Ad on page 25 Jim & Catherine Douglas (jmdouglas35@verizon.net) 973-338-77877

SQUARE DANCING FUN with the

Kittatinny Rangers

2ND & 4TH FRIDAYS, 7:30 - 10:00 PM
MAINSTREAM & PLUS (ALTERNATING)

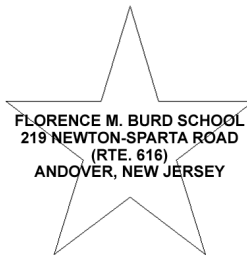

DATE	CALLER	THEME
September 11	Wayne Applegate	Patriot Day
September 25	Lucille Ims	Apples for All
October 9	Len Anfinen	Shades of Autumn
October 23	Ron Kapnick and guest	Halloween
November 13	Dennis Reardon	A Time for Thanks
December 11 *	Jim Snyder	<i>Student Dance</i>
January 8	Dennis Reardon	Winter Fun
January 22 *	Wayne Applegate	<i>Student Dance</i>
February 12	Jim Snyder	Sweetheart Dance
February 26	Fran Wadel	Safari Time

For Internet directions: Use 219 Newton-Sparta Road, Newton, NJ 07860

For more information: Bob and Francine Leshnowar (973-697-6816)

Dance night: Donna Poyer (908-619-2296) or Mike Szekula (908-319-9412)

Discount Printing at Office Depot

In these times of economic stress, we've arranged for a deep discount on square dance printing at any Office Depot. Unless you have a way to print flyers and other materials at no cost, your club could save significant sums by signing up:

- black and white printing – 3¢ a page
- color printing – 39¢ a page
- laminating, punching, and binding – 25% off

Individual store managers may provide additional discounts upon request.

To register your club, contact one of our NNJSDA sales representatives: Sheldon.Exter@OfficeDepot.com, 973-356-3034 or Eleomarys.Hernandez@officedepot.com, 212-330-6480 x178. Give him or her the NNJSDA account number (48162579), your club name, the credit card(s) your club will use, and your contact information. Once your club is registered, the credit card(s) will serve as a Store Purchase Card for obtaining the discount.

Lise Greene

Ad Makers and Reporters Alert

All deadlines are the **7th** of the month: March, July, and **November**.

Please cover dances and news for mid-January through May.

REMEMBER: Payment is due when you submit your ad and now goes directly to Rusty Ball, NNJSDA Treasurer.

MASQUERADERS – Hightstown

Sept. 4 – last dance

Rich Delgado: 609-844-1140

PL/RD

First Baptist Church, 125 S. Main St., 08520

Cell for dance night: 609-575-1890

From Exit 8 NJ Turnpike, take Route 33 (Mercer St.) westbound to downtown Hightstown. Turn left onto Ward Street (1st legal left after light for Rt. 571). Go one block and then left onto South Main (Rt. 539). Parking lot entrance is on the right before the church and the intersection of South Main and Rt. 33 (stop sign).

We are happy to report that our class completed the Mainstream program. We appreciate Co-President Ken Robinson's attendance at our graduation dance. During the summer, our class met at my house to work on the Plus program.

At our annual meeting, the membership voted to cease operations following our September 4 dance. The club has been losing money on most of our dances and finally exhausted its treasury. Please join us as we celebrate our many years of dancing at **our last dance on Friday, September 4** with caller Roy Leber. This dance will have alternating Plus and Mainstream tips; recent graduates and experienced dancers are welcome at this dance. This will be our traditional and popular ice cream social, so make sure you leave room for dessert.

Please also note that a **new club is forming** in the Mercer County area. Look for further announcements. Contact Rich Delgado for membership information.

Ad on page 63

Rich Delgado (richdelgado@verizon.net)

609-844-1140

Pay It Forward

Do you remember when you were a new dancer? I do! Luckily, we had wonderful, patient support from our club and from dedicated angels whom I still remember fondly. They were not turned off by our wobbly performance. They invited us along to dance at other clubs and drove us there. In addition, new and experienced dancers from many clubs danced at the workshops held by Bob Tarrant every Friday night.

It was a far different experience when my partner and I tried duplicate bridge. The experienced players made us feel we were holding them back; we felt unwelcome. We were sure we would learn quickly, but instead, we dropped out.

Therefore, I have been so grateful for the wonderful patience that greeted my learning to square dance more than 20 years ago that I still want to "pay it forward." Dancing with beginners is not the same stimulating challenge as dancing with very experienced dancers. The passing on of a skill you love is fun and rewarding in a different way. Seeing the people you have mentored grow into skilled dancers who love to dance can't be matched.

I hear numerous comments that Mainstream dancing is not as strong as it used to be. How can newer Mainstream dancers become strong without the interest and the mentoring of the experienced dancers? Here are a few suggestions.

- Stronger dancers: Invite newer dancers into your squares, at least for some of the tips. Try to more evenly distribute the newer dancers among all the squares. It is difficult for weaker dancers to learn and succeed when on their own, and it is discouraging to break down frequently.

Continued on page 41



Motiv8ors



NEW JERSEY'S PREMIER ADVANCED & CHALLENGE CLUB Sundays at the VFW Hall

6 Veterans Place (behind Firehouse), Elmwood Park, NJ 07407

C1 Program - 6:30-7:30 pm, A2 Program - 7:30-9:30 pm

Sept. 13	Mike Jacobs, NJ	Oct. 25	Ken Ritucci, MA
Sept. 27	Dayle Hodge, MD	Nov. 29	Todd Felleggy, CT
Oct. 18	Mark Franks, NJ *****	Dec. 6	Ken Ritucci, MA
	A2/ C1 tip, 7:00-9:30 pm	Dec. 20	Mike Jacobs, NJ

FOR ADDITIONAL DANCES, check our website motiv8ors.nnjsda.org

Singles Welcome Casual Attire Computer Squares
Chariss & Carl: 201-489-2498, charartist@aol.com Roberta: 201-262-1570



Pay It Forward continued from page 40

- Try taking your newer dancers to Mainstream clubs on those weeks when you have no dance. If you are a Plus club with recent graduates, this will solidify their fundamentals.
- ABC drop-in dances can be a source of new dancers. Ours produced four people interested in taking classes, although not with us. Square dancing, in general, benefited. Look at ABC dancing as an opportunity to grow new dancers, to mentor newcomers. Without them, more clubs will dwindle and die. If you cannot start your own ABC dances, why not support other clubs' efforts by offering yourselves as mentors and recruiters?
- Conduct Mainstream brush-up workshops or bring your dancers to those run by other clubs. It can lead to more challenging dances for all of us.
- Encourage the newer dancers to dance, dance, dance, and accompany them to dances to make sure they do.

We can only have stronger, more interesting Mainstream and Plus dancing and enough dancers to keep our clubs alive if we are willing to work at it. Won't you pay forward some of the interest and patience that was invested in you by supporting our newer dancers?

Kathy Keener, President, Lakeland Squares

AleMO Squares

Our Lady of Grace R.C. Church
Avenue W and East Fourth Street, Brooklyn, NY 11223

Sundays 7:30 – 10:00 pm Alternating MS & PL

Sept. 13: Randy Longobucco Oct. 11: Don Coy

Nov. 22: Howard Richman

Dec. 13: Don Coy Jan. 10: Lee Kopman

For further information contact:

Kathy: 917-699-2093 (Cell), Bob: 718-833-5456, Norma: 718-852-0318
alemodancer@yahoo.com Directions: See Map page 16

ADMISSION \$7.00 per person

THE CARING AND SHARING CLUB

MIDDLETOWN RAMBLERS – Leonardo

PL

www.middletownramblers.org

Every Fri. All Year Hall

Croyden Hall, 900 Leonardville Rd., 07737

Kenneth Douglas: 732-581-4361

Cell for dance night: 732-581-4361

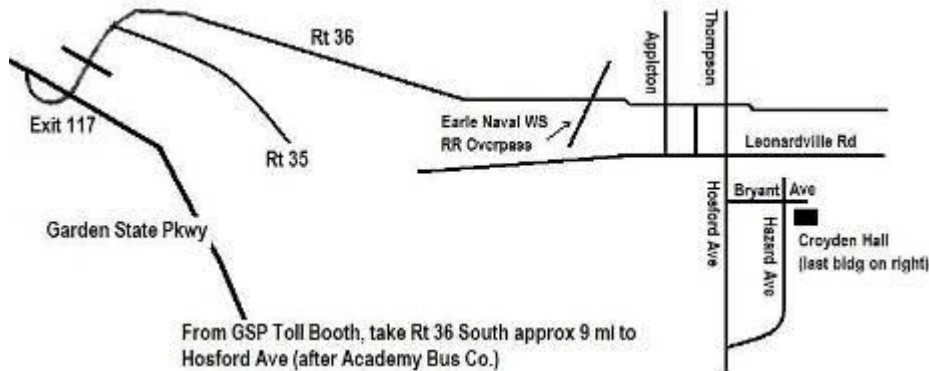

Ad on page 13

What Can We Do with Extra Grand Squares?

Revise the number of copies you request, then:

- * Display at various health professionals' waiting rooms
- * Display at libraries, local recreation departments, adult communities' rec centers
- * Send one to an out-of-area dancing friend * Recycle

Advanced Class

with Andy Woerner
starts
Thursday September 17th 8-10 PM
in Oradell N.J.

for experienced plus dancers

for info call (201) 261-1047 please register in advance

MOTIV8ORS – Elmwood Park

A2/C1

www.motiv8ors.nnjsda.org

Various Sun.

VFW Hall, 6 Veterans Pl., 07407

Chariss Smith & Carl Luhrs: 201-489-2498

For map, see page 53.

Our sincere appreciation goes to Chariss Smith and Carl Luhrs for agreeing to continue in their role as president, as well as to the other members who contribute to the running of our club. It is truly a team effort. Carl is also helping to green our Garden State by bringing in plants for those who wish to plant them in their yards.

Our spring and summer Sunday evenings were filled with dancing to talented national callers: Sandra Bryant, Todd Fellego, Eric Henerlau, Mike Jacobs, Roy Leber, Don Moger, Ken Ritucci, and Keith Stevens. You never know what to expect for our final **fun** tip. All boys/all girls squares made slide thrus and star thrus more challenging. During “do the opposite,” left was right and in was out. Let’s just say there were lots of laughs. Our thinking caps were really needed for “do the call in reverse” (for example, right and left thru became courtesy turn followed by a right pull by). You really had to know your definitions. One thing for certain: Our **fun** tips are always good **fun**!

PLEASE NOTE: On October 18, Mark Franks will be calling an all A2 dance 7:00-9:30 pm (with a C1 star tip), which is different from our usual format and time.

We happily welcomed Roberta Bruno back to the dance floor after her surgery to remove a brain tumor. Everyone knows that yellow rocks and dancing are important parts of anyone’s recovery.

We extend our heartfelt condolences to Louis Thompson upon the passing of his father. May you know no more sorrow.

Judy and Sam Soffler returned to Motiv8ors after three weeks in New Zealand visiting their daughter and her family. Brian and Scott Thompson spent four weeks in Israel combining learning with sightseeing and recreational activities. From June through August, their parents, Jan and Louis, made the rounds (and squares) dancing in the Poconos, Wisconsin, Maryland, central Pennsylvania, and Indiana.

Come join the fun of Advanced and Challenge dancing at Motiv8ors!

Ad on page 41 Jan & Louis Thompson (LTPT1@yahoo.com) 732-577-9413

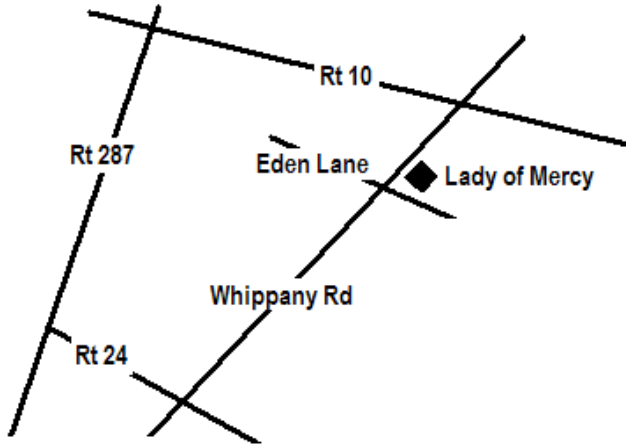

After a successful winter season, Mountain Squares had a wonderful potluck dinner featuring the most delicious dishes.

Our great raid program featured nine raids with two to four squares attending each raid. We thank Mary Jane and Greg Roome, our raid chaircouple, for their organizational skills and successful planning. We've already held the first raid for the new season at Hix & Chix in June.

On a sad note, we lost a long time dancer, Jane Monheimer. Jane was a lovely and gracious lady who loved square dancing. We extend our sympathy to her husband and family.

Although Mountain Squares did not hold dances during the summer, many of our members danced at Cherry Ridge, Summer Sizzler, the Nationals (in California and Canada), and other square dance events and clubs.

Ad on page 14 Paula & Roy Lawrence (rlawr3@ptd.net) 973-726-9463

Louisville Again in 2010
59th National Square Dance Convention
June 23-26

www.59thnsdc.com reghousing@59thnsdc.com

Why Louisville, Kentucky?

There will be great dancing including squares, rounds, lines, contras, and more. The best callers, cuers, and instructors from around the world will be gathered there for your dancing pleasure. The Social and Special Events Chairmen, Ives & Carol Pruett, have put together an array of tours and entertainment that will make you want to come early and stay longer.

Register now!

1 & 3 Fri. Sept-June

Ironia Elem. School

Linda & Rick Murphy: 973-539-9315

303 Dover-Chester Rd. (Rt. 513), 07869

Cell for dance night: 201-572-5073

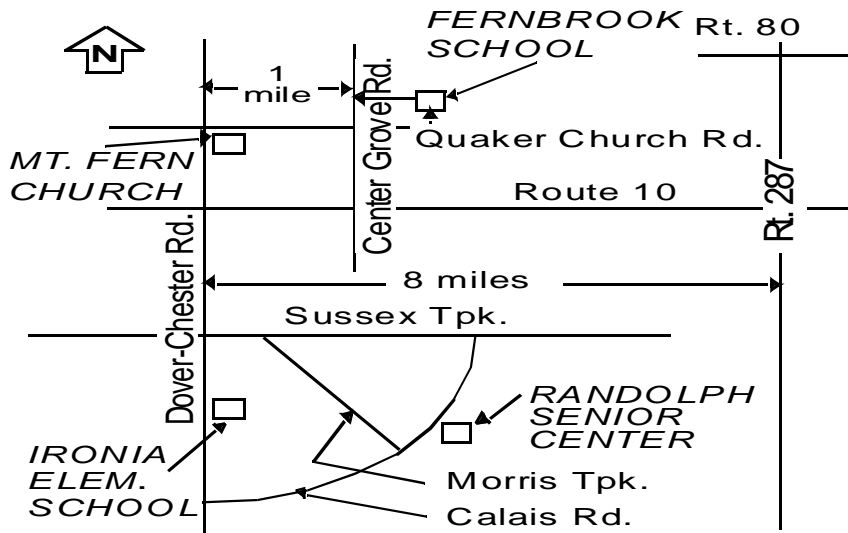

The highlight of our season had to be the Cinco de Mayo dance. Mark Franks called for 93 dancers, including raiders from three clubs, and round dancers circled the hall to the cueing of Mary Pickett.

We were busy raiders ourselves this year and completed the Raid Program. It's an extra pleasure to raid because you only have to enjoy the dancing – no club responsibilities!

Fran Wadel continued teaching Plus workshops along with a new Mainstream class. The workshopers served as angels for the new students. Our six Mainstream graduates are going right on to a Plus class starting September 15, and anyone else who would like to learn Plus is invited to join in at 7:30 on Tuesday evenings at Ironia School. A new Mainstream class is expected to begin in January.

Mary Pickett's beginner and intermediate round dance classes are ongoing in Morris Plains on Monday evenings. New members are always welcome.

Many Reelers enjoyed dancing with other clubs during the summer, and we had a club potluck picnic at Lake Hopatcong in August.

Matty Sharkey comes up with some great dance themes, and Av Brady is a pro at announcing them with a unique flair. Next time you see one of her creative emails, come and join in the fun!

The 50th anniversary of the Reelers will be celebrated at a dinner dance on Sunday, April 10, 2011. We're already planning for it, so mark your calendars and watch for details.

Ads on pages 21, 53 Lise Greene (lise.greene@montclair.edu) 973-663-4396

ROCKLANDROCKYTOPS – West Nyack, NY

www.sqrdance.org/RocklandRockytops

MS-PL tip 2 Fri. All Year

PL-A1 tip 1 Fri. Oct-June

PL-A1 tip 3 Fri. July-Aug

David & Miriam Gurowsky: 845-354-6351

Cell for dance night: 845-893-7687

West Nyack Firehouse

42 Strawtown Road, 10994

**Directions to West Nyack Firehouse
42 Strawtown Road, W. Nyack, NY 10994**

From Palisades Interstate Parkway:

Take Exit 8-E (Route 59 East). Continue on Route 59 to first traffic light. Turn left onto Crosfield Avenue to the end. Turn right onto West Nyack Road and continue to traffic light. Turn left onto Strawtown Road. Firehouse is just past yellow blinker on the right.

From New York State Thruway:

Take Exit 13S to Palisades Interstate Parkway. Go ½ mile to Exit 8-E (Route 59 East). (***Follow instructions above for Palisades Interstate Parkway.***)

From Kinderkamack Road (NJ):

Kinderkamack Road becomes Route 304 in New York. Follow Route 304 North to Route 59 East. Turn onto Route 59 East. (***Follow instructions above for Palisades Interstate Parkway.***)

RocklandRockytops concluded its 2008-2009 season with a number of successful raids: 11 members raided Tenakill Twirlers, 15 visited Circle Eights, and two full squares raided F.A.D. Squares.

During the summer, the Blotners spent a week in Boothbay Harbor, Maine with the Landons, who were the second presidents of Rockytops. Many of you danced with us in our air-conditioned hall. Intro dances – free to the public – were held prior to our Mainstream dances. We will have one more introductory dance on Friday, September 11, from 7:30 to 8:30 pm, prior to our Mainstream dance. Bring everyone you know to experience our great activity.

Carol Van Nahl, one of our 2009 Mainstream graduates, brought a number of friends to a wonderful introductory dance called by Howard Richman in June. Carol and fellow graduate Karen Mallozzi are so enthusiastic that they attended a square dance weekend in Massachusetts even prior to their graduation. Way to go, Carol and Karen!

We'd like to thank all who faithfully served as club officers this past year: Club Chairs Mal and Dotty, President Greta, Treasurers Don and Cathy, Asst. Treasurer Sherry, VP-Callers Marty and Beverly, VP-Facilities Joe, VP-Classes/Raid Chair Patsy, Co-Class Coordinators Marie and Ray & Rose, VP-Refreshments (MS) Ray and Rita, Co-VP-Refreshments (Plus) Dave & Miriam and Fred & Marion, NNJSDA Delegates Dave & Miriam, HVSDC Delegate Justin, Sunshine Chair Clare, and Co-Hospitality Hosts (MS) Dave Dupas, Pat Hoffman, and Grace Meyer.

We welcome new Presidents Dave and Miriam, who will also continue as NNJSDA Delegates. We look forward to having Richard Behrens back dancing this fall after recuperating over the summer from his second hip surgery.

Ad on page 15 Joan Schierlitz (dancinggrandma@verizon.net) 845-353-2987

Hi Taws - A Challenge Club

Various Tuesdays

Paramus Senior Center - 93 Farview Avenue, Paramus, NJ

Challenge Dancing: C2 - 7 pm to 8 pm C1 - 8 pm to 10 pm

Information: Bernie & Sandy 201-447-0538 Fred 201-797-3421

RUTGERS PROMENADERS – North Brunswick

MS/RD

www.rutgerspromenaders.org

1 & 3 Sun. Sept-June

American Legion, 1015 Linwood Pl., 08902

Ken Robinson: 908-963-2447

Cell for dance night: 908-963-2447

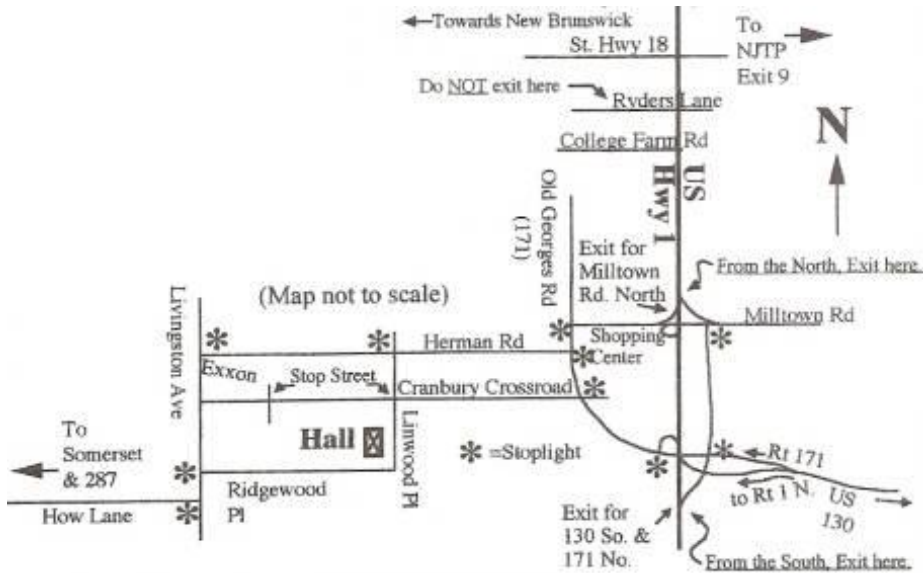

It was a busy and interesting time as we ended our dance season. On April 4, Dan Koft provided an hour set at the Rutgers Dance Marathon ... to 70 dancers!

During the latter part of our season, thanks to the special efforts of our cuers, Kathy and Roy, we provided opportunities for those in attendance to expand their horizons in the dance world. Our cuers volunteered and ably taught "Tips of Your Fingers" for the benefit of our class and less experienced dancers. We also enjoyed a special introductory contra dance led by caller Dan in May.

During our last dance in June, we were raided by Circle Eights. June was also a busy month for graduations (Will Lewis), advanced degrees (Dan Koft), and anniversaries (Roy and Betsy Gotta, Bernie and Betty Koft). Congratulations to Will on his engagement!

Best wishes to Dean Smires on his hastened deployment to Afghanistan; may he come home safely and as soon as possible.

Condolences go out to President Ken on the loss of his father.

Ad on page 9 Mary Ann Ryan-Erdek (erdekfamily@verizon.net) 732-271-9151

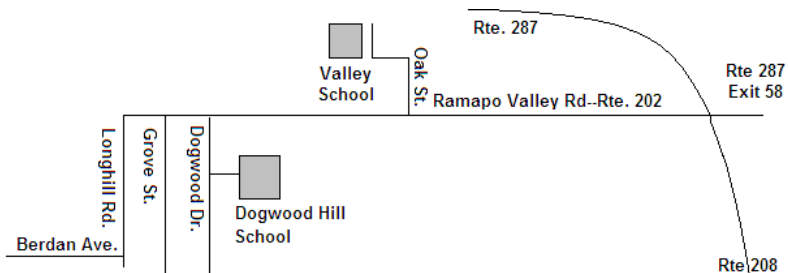

From Rte. 208/287: Exit 58 (Oakland) Take Rt. 202 (Ramapo Valley Rd.) South into center of Oakland.

Dogwood Hill School is .8 miles. Turn left on Dogwood Drive; turn left after 5 houses into school driveway.

Valley Middle School is .5 miles. Turn Right on Oak St. Take 1st left into Borough Hall parking lot and then immediate right down hill to side of Valley School.

From Wayne: Take Berdan Ave. to end; turn left on Longhill Rd. to traffic light; turn right on Rte 202; take 2nd right onto Dogwood Drive.

Another square dance season has come and gone, but many fond memories remain. We had a number of top-notch callers visit us. Some of them were local, but others came a long way, such as Rick Gittelman from Arizona.

Charles Thiemann, a long time member of Spinning Wheels, is continuing to recuperate from an ankle injury. The good news is that Charles is out of the convalescent center and is now walking around with the help of a walker. Diana LePore, another long time member, has finally retired and is enjoying the freedom that retirement brings.

Spinning Wheels is one of the very few clubs in the Association that holds weekly dances. In addition to our Mainstream program, we offer a Plus workshop at the beginning of each dance and line dancing between tips. We welcome all visitors, singles and couples. With our spacious hall and convenient location, one couldn't ask for a better dance venue.

Ad on page 27 Greg Fokszye (thegregster@verizon.net) 973-403-1854



Louisville Again in 2010
59th National Square Dance Convention
June 23-26

Norman and I have attended six national conventions now. Each one has been great fun. If you have never been to a National Convention, this is a very easy one to start with. There will even be a tour bus going down from our area.

In addition to great dancing and a first class selection of vendors, you will find a host of educational seminars planned. The seminars can provide clubs with valuable ideas that have worked in other areas. How about aiming for "one square is fair" for the National? What a great turnout the NNJSDA would have then! Let's plan together to make Louisville a truly memorable convention.
Barbara Kanter



HUNTERDON FLUTTERWHEELS
 Echo Hill Park, 43 Lilac Drive, Stanton Station, NJ
 Web Address: hunterdonflutterwheels.njjsda.org
 Contact # night of dance: 908-672-0372



<u>2009</u>	<u>Theme</u>	<u>Caller</u>
Sept. 18	Welcome Back - Let's Start Dancing!	Ed Kerns
Oct. 2	Crazy Hat Night - Wear Your Funniest Hat	M. McFarland
16	Cowboy & Cowgirl - Back Home on the Range	Ed Kerns
Nov. 6	Train Theme - Ride the Rails, Don't Leave Tracks	H. Richman
20	Food Bank Night - Contribute Food for Others	Ed Kerns
Dec. 4	Broadway Bash - Dance the Night Away	Don Coy
18	Harry's Ho Ho Ho Holiday Dance	Ed Kerns
<u>2010</u>		
Jan. 1	No Dance - <i>New Year's Day</i>	
15	Winter Music - But NO Snow at this Show	Fran Wadel

Alternate Mainstream & Plus Level Tips

Soft Sole Shoes Please!

1st & 3rd Fridays 8:00-10:15 pm



For Information:

Donna & Joe 908-526-7496

Ruth & Harry 908-369-6471

Peg & Fred 908-574-5095

Seeing the Hear-2-DanceSM logo on ads?

At those dances, a special transmitter is set up so that the caller/cuer's voice goes directly into a Walkman radio and headset or ear buds worn by a dancer.

This decreases noise, distractions, and bad acoustics, and is designed to be used with or without hearing aids.

There is a sample set at NNJSDA dances if you are curious.
 (See Hear-2-Dance.com for more information.)





Western Wheelers

PLUS CLASS

with
Andy Woerner

TUESDAY EVENINGS in Oradell NJ starting September 15th

Have FUN learning all position plus this winter
 for more details call (201) 261-1047

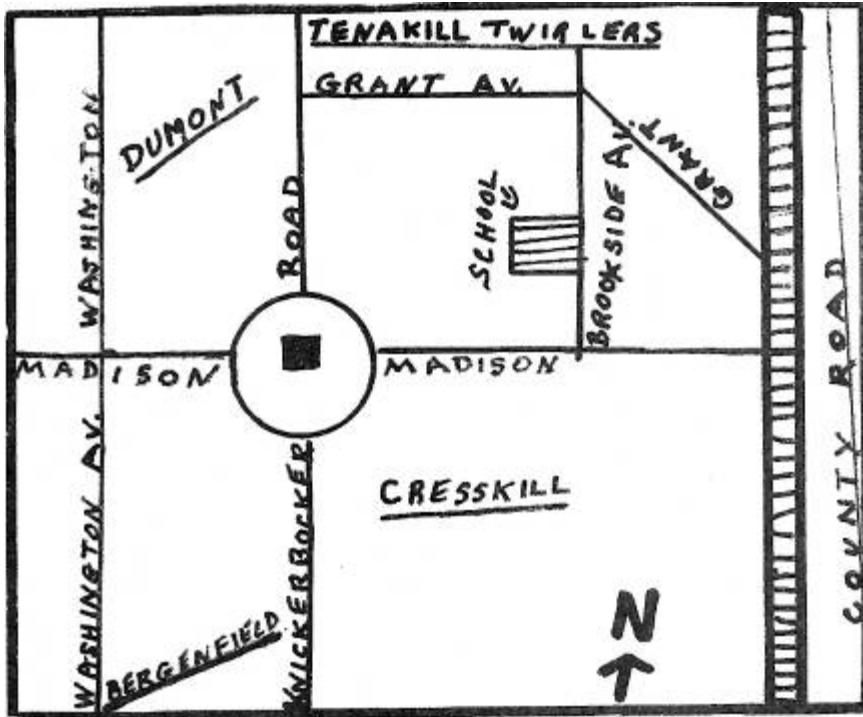

Tenakill Twirlers concluded the 2008-2009 season with a lively dance called by Dan Koft. The five squares in attendance included a raid from RocklandRockytops. Now we are ready to begin our 59th square dance season. Our season's opener in October will be called by one of our favorites, Roy Leber. Hope to see you there!

It is my sad duty to report that in June, long time Tenakill Twirlers member Richard Marcell passed away. Richard (also known as Dick) and his wife, Joan, have been greeting you at our treasurer's table for many years. Our deepest sympathy to Joan and their family. We share your loss. Tenakill Twirlers made a contribution in Richard's memory to his alma mater, Johns Hopkins School of Engineering.

We hope the new season holds only good things in store for all. See you on the dance floor!

Ad on page 12 Joan Schierlitz (dancinggrandma@verizon.net) 845-353-2987

35th ANNUAL
MINI-FESTIVAL
SUNDAY, NOVEMBER 8, 2009

See page 33 for details.

YMCA/Chisholm Community Center

100 S. Springfield Ave. at Shunpike, Springfield, NJ 07081

NNJSDA Delegates Meeting: Sunday, September 13, 2009

[Also hall for the Five Clubs.]

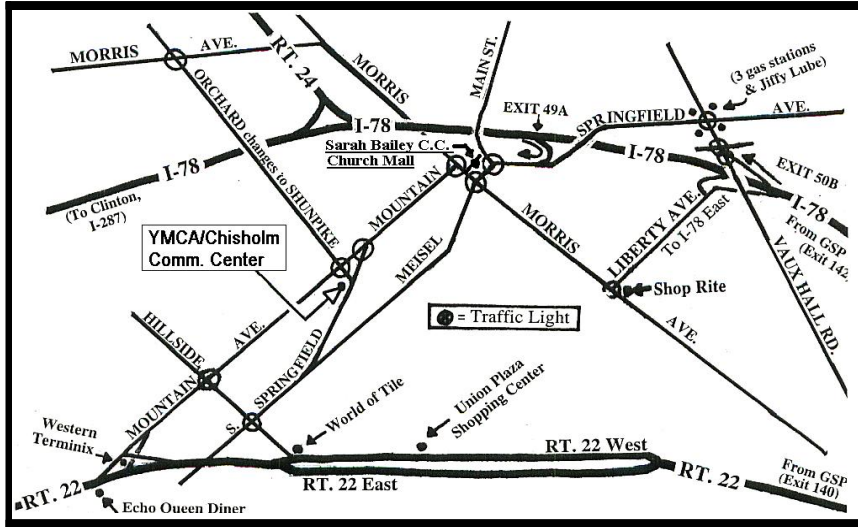

St. Aloysius Church (next to Grover Cleveland Birthplace)

NNJSDA Dances: Friday, October 30; Saturday, January 30

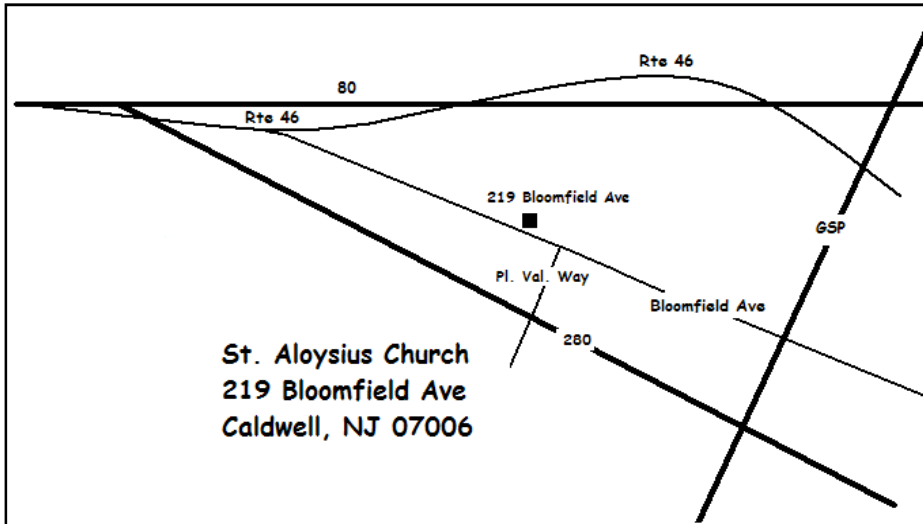

GSP: Exit 148 (Bloomfield Ave). Church is about 6 miles west on Bloomfield on right.

80 East: Exit 47B, Rte 46E; 2 miles, bear right onto Bloomfield Ave (Caldwell). Church is 3 miles on left.

Rte 280: Exit 7 (Pleasant Valley Way) to end (3 miles). Left onto Bloomfield Ave. Church is 1½ miles on right.

See NNJSDA.org for Google directions to all NNJSDA dances.

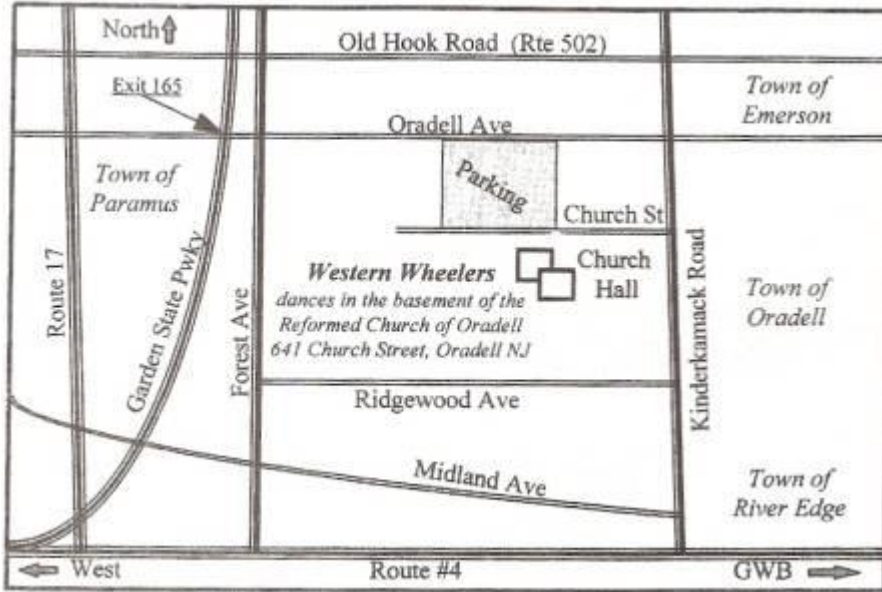

Sadly, I must report a great loss to our club and to the square dance community. Ed Spincken passed away after an eight year struggle with cancer. Ed was a dedicated person who, up until the very end, worked hard to help our club. Among other responsibilities, he served as co-president, designed our ads and flyers, and maintained our files of past New Year’s Eve dances. Thank you, Ed, and may God bless your wife, Rose, for being at your side and helping you keep up your courage. Ed shall be greatly missed and will always hold a special place in our hearts.

After our regular season, Western Wheelers raided Kittatinny Rangers on May 8. We once again enjoyed co-sponsoring summer dances with Hix & Chix.

Maria and Roger Hoernlein are bursting with pride over their grandson Nolan’s acceptance to the United States Air Force Academy. Gus and I know that feeling of pride too, because our granddaughter, Christine, graduated from The College of New Jersey with honors and has already advanced one year toward her CPA. Anna Lou and Jerry Beckmann attended their granddaughter Carla’s wedding, which took place on a cruise ship.

Bob Bachmann is planning a trip to Germany in the fall. Western Wheelers members learned first hand how exuberant and fun loving German dancers are when we hosted a group brought by caller Don Coy. It was a most pleasurable and entertaining evening for everyone.

We welcome all to Western Wheelers, “The Friendly Club.”

Ad on page 29

Marilyn P. Bachman (margus258@aolcom)

201-261-3921

Callers' Council of New Jersey presents

MID-WINTER MANIA



a special dance (featuring multiple callers) for all

DANCERS IN CLASSES (and angels)



Sunday, February 28, 2010, 2:30-5:00pm



VFW Elmwood Park

6 Veterans Place, Elmwood Park, NJ

VFW Hall, 6 Veterans Place, Elmwood Park, NJ 07407

See NNJSDA.org for Google directions.

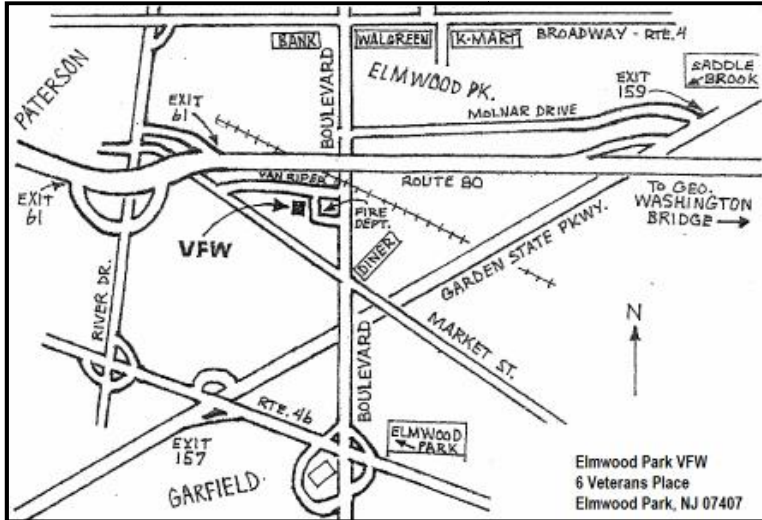

NNJSDA Delegates Meeting and NNJSDA Mid-Term Dance:
Sunday, January 10, 2010

NNJSDA Dance: Sunday, April 25, 2010

[Also hall for Motiv8ors, Hix & Chix, Belles & Beaux Summer Dances]

PLUS CLASS

Ironia School

303 Dover-Chester Road (Route 513), Randolph 07869

Tuesdays 7:30 - 9:30 PM (starts 9/15/09)

Teacher: Fran Wadel *Fee:* \$50 (complete program)

Info: Bonnie and Charlie Van Stone 908-832-5313



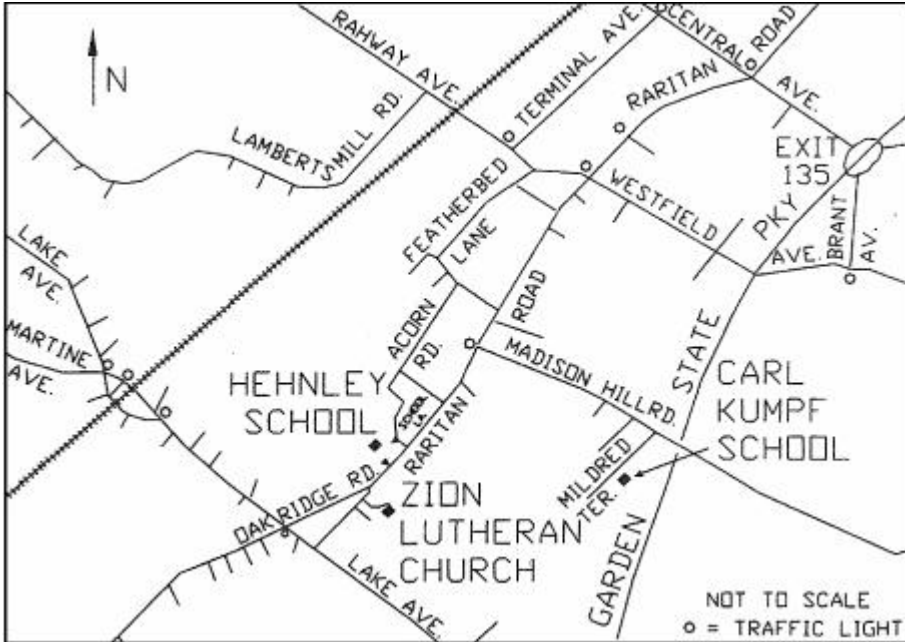

Y Squares will begin the 2009 dance season with a new format: alternating Mainstream/Plus and rounds. If there are no Mainstream only dancers present at a dance, all tips will be Plus program that evening. We will have an open house on September 15 and a barn dance on January 8. Please join us, and bring all of your friends! At our Halloween Dance on October 23, we will have a White Elephant Sale. Our raid chairpersons, Al and Judy Kendziora, would like to invite your club to come and raid Y Squares. Al promises, "If you raid us, we'll raid you!"

Three of our couples attended the National Convention in Long Beach, CA in June: the Sandersons, the Stomses, and the Kuhnes. The Stomses toured a number of national parks while they were out west. In July, the Kendzioras had a week long family reunion in Cape Cod with their six children, their spouses, and six grandchildren. In August, they attended Judy's 50th high school reunion in Erie, PA. The Maddens attended a family reunion in Titusville, PA.

Ad on page 23 Dianne Madden & Don (olreggie@comcast.net) 609-693-0247

NNJSDA New Dance Format: Is It Working for You? Page 21

Hand Washing for Health Page 30

Pay It Forward Page 40



CROSS TRAIL SQUARES

PRESENTS THEIR

42nd ANNUAL DINNER DANCE

SUNDAY, MARCH 14, 2010

**At
The Brownstone House
351 W. Broadway
Paterson, NJ 973-595-8582**

12:30 PM TO 4:30 PM

Caller: Howard Williamson (Pa.)

Alternating Mainstream and Plus

FAMILY STYLE DINNER AND BEVERAGES

**\$35.00 per person
RSVP no later than Feb. 24, 2010**

All Clubs Welcome

Information:

Alice DeLancey 973-618-9025 or Sal and Mary Alessi 973-256-1647

Please Print

Name _____ Club _____

Address _____

City _____ State _____ Zip+4 _____

_____ Tickets @ \$35 each -----Total Amount Enclosed \$ _____

Please make checks payable to **Cross Trail Squares** and mail to:

Sal Alessi
5 Villa Road
Little Falls, NJ 07424-2315

CALENDAR OF ADVERTISED DANCES

Listing of dances, weekends, and workshops prepared from ads appearing **IN THIS ISSUE**. See ad for details. *Dances that are not club level are italicized.* All dances are in NJ unless specified.

Abbreviations: A = Advanced; B = Basic; C = Challenge; CW = Country & Western; MS = Mainstream; PL = Plus; RD = Rounds; TBA = To Be Announced; WS = Workshop

We have dropped the use of Alt.

The / indicates equal time in the program. The – indicates one tip.

Date	Club	Caller/Cuer/Leader	Place	Program
September				
2	Belles & Beaux	McFarland	Elmwood Park	MS – PL tip
4	Masqueraders	Leber	Hightstown	MS/PL
6	F.A.D. Squares	McFarland	Paramus	MS – PL tip
7	Spinning Wheels	G. Hardy/Gesumaria	Oakland	MS/CW – PL tip
9	Cross Trail Squares	Coy	Caldwell	MS/PL
11	Bee Sharps	Franks/Bradt	Bound Brook	MS/PL/RD – A tip
	Kittatinny Rangers	Applegate	Andover	MS/PL
	Middletown Ramblers	Goss	Leonardo	PL
	RocklandRockytops	Richman	W. Nyack, NY	MS – <i>ABC</i>
	Y Squares	Koft/Koft	Clark	MS/PL/RD
13	AleMo Squares	Longobucco	Brooklyn, NY	MS/PL – A tip
	Motiv8ors	Jacobs	Elmwood Park	A2/C1
14	Spinning Wheels	Leber/Gesumaria	Oakland	MS/CW – PL tip
15	Lakeland Squares	D. Page	Montville	MS – PL tip
	<i>Y Squares</i>	<i>Koft</i>	<i>Clark</i>	<i>Open House</i>
16	Belles & Beaux	Applegate	Glen Rock	MS – PL tip
	Mountain Squares	Landi	Whippany	A2
18	Hunterdon Flutter.	Kerns	Stanton Station	MS/PL
	Masqueraders	Ritucci/TBA	Hightstown	PL/RD
	Middletown Ramblers	Koft	Leonardo	PL
	Reelers	Wadel/Pickett	Randolph	PL/RD
20	F.A.D. Squares	Leber	Paramus	MS – PL tip
	Rutgers Promenaders	Gottas & Kofts	No. Brunswick	MS/RD
21	Spinning Wheels	Applegate/Gesumaria	Oakland	MS/CW – PL tip
22	Lakeland Squares	Amor	Montville	MS – PL tip
23	Cross Trail Squares	Jacobs	Caldwell	MS/PL – A tip
25	Bee Sharps	Richman/McGee	Clark	MS/PL/RD – A tip
	Circle Eights	Martellacci	Haworth	MS – PL tip
	Kittatinny Rangers	Ims	Andover	MS/PL
	Middletown Ramblers	Coy	Leonardo	PL
	Y Squares	Franks/Kushla	Clark	MS/PL/RD
26	Western Wheelers	Jacobs/Millar	Oradell	PL/RD – A tip
27	Motiv8ors	Hodge	Elmwood Park	A2/C1
29	<i>Lakeland Squares</i>	<i>Richman</i>	<i>Montville</i>	<i>Barn Dance</i>
October				
2	Hunterdon Flutter.	McFarland	Stanton Station	MS/PL
	Middletown Ramblers	Landi	Leonardo	PL
	Reelers	Matthew/Pickett	Randolph	PL/RD
	RocklandRockytops	Franks	W. Nyack, NY	PL – A tip
4	F.A.D. Squares	Martellacci	Paramus	MS – PL tip
	Rutgers Promenaders	Gottas & Kofts	No. Brunswick	MS/RD
5	Spinning Wheels	Coy/Gesumaria	Oakland	MS/CW – PL tip
6	Lakeland Squares	Leber	Montville	MS – PL tip
7	Belles & Beaux	Richman	Glen Rock	MS – PL tip
	Cross Trail Squares	Snyder	Caldwell	MS/PL – A tip
	Mountain Squares	Landi	Whippany	A2

October continued

9	Bee Sharps Kittatinny Rangers Middletown Ramblers RocklandRockytops Y Squares	Snyder/Denniston,McCabe Anfinsen Butler Corey Koft/Koft	Bound Brook Andover Leonardo W. Nyack, NY Clark	MS/PL/RD – A tip MS/PL PL MS – PL tip MS/PL/RD
10	Western Wheelers	Snyder/Millar	Oradell	PL/RD – A tip
11	AleMo Squares	Coy	Brooklyn, NY	MS/PL – A tip
12	Spinning Wheels	Leber/Gesumaria	Oakland	MS/CW – PL tip
13	Lakeland Squares	Patton	Montville	MS – PL tip
14	Cross Trail Squares	Martellacci	Caldwell	MS/PL – A tip
16	Hunterdon Flutter. Middletown Ramblers Reelers Tenakill Twirlers	Kerns Snyder Reardon/Pickett Leber	Stanton Station Leonardo Randolph Cresskill	MS/PL PL PL/RD MS – PL tip
18	F.A.D. Squares Motiv8ors Rutgers Promenaders	Coy Franks Gottas & Kofts	Paramus Elmwood Park No. Brunswick	MS – PL tip A2 – C1 tip MS/RD
19	Spinning Wheels	Snyder/Gesumaria	West Paterson	MS/CW – PL tip
20	<i>Lakeland Squares</i>	Coy	<i>Montville</i>	<i>ABC</i>
21	Belles & Beaux Mountain Squares	Applegate Landi	Glen Rock Whippany	MS – PL tip A2
21	Cross Trail Squares	Martellacci	Caldwell	MS/PL – A tip
23	Bee Sharps Circle Eights Kittatinny Rangers Middletown Ramblers Y Squares	Gotta/Gotta Reardon Kapnick Coy Ritucci/Kushla	Bound Brook Haworth Andover Leonardo Clark	MS/PL/RD - A tip MS – PL tip MS/PL PL MS/PL/RD
24	Western Wheelers	Reardon/Millar	Oradell	PL/RD – A tip
25	AleMo Squares Motiv8ors	Leber Ritucci	Brooklyn, NY Elmwood Park	MS/PL – A tip A2/C1
26	Spinning Wheels	Richman/Gesumaria	Oakland	MS/CW – PL tip
27	Lakeland Squares	Reardon	Montville	MS – PL tip
28	Cross Trail Squares	Snyder	Caldwell	MS
30	Middletown Ramblers	Richman	Leonardo	PL
30	NNJSDA	Callahan/Denniston,McCabe	Caldwell	MS/PL/RD

November

1	F.A.D. Squares Rutgers Promenaders	G. Hardy Gottas & Kofts	Paramus No. Brunswick	MS – PL tip MS/RD
2	Spinning Wheels	G. Hardy/Gesumaria	Oakland	MS/CW – PL tip
4	Belles & Beaux Mountain Squares	Applegate Landi	Glen Rock Whippany	MS – PL tip A2
6	Hunterdon Flutter. Middletown Ramblers Reelers RocklandRockytops	Richman Applegate Franks/Pickett Ritucci	Stanton Station Leonardo TBA W. Nyack, NY	MS/PL PL PL/RD PL – A tip
8	35th NNJSDA Mini-Festival	Biggerstaff, Franks, Gotta/ Gotta	Bridgewater	MS/PL/AC/RD
9	Spinning Wheels	Foote/Gesumaria	Oakland	MS/CW – PL tip
10	Lakeland Squares	Foote	Montville	MS – PL tip
11	Cross Trail Squares	Foote	Caldwell	MS/PL – A tip
13	Bee Sharps Kittatinny Rangers Middletown Ramblers RocklandRockytops Y Squares	Koft/Koft Reardon Kauffman Foote Williamson/Williamson	Bound Brook Andover Leonardo W. Nyack, NY Clark	MS/PL/RD – A tip MS/PL PL MS – PL tip MS/PL/RD
14	Western Wheelers	Anfinsen/Millar	Oradell	PL/RD – A tip

November continued

15	F.A.D. Squares Rutgers Promenaders	Foote Gottas & Kofts	Paramus No. Brunswick	MS – PL tip MS/RD
16	Spinning Wheels	Applegate/Gesumaria	Oakland	MS/CW – PL tip
17	Lakeland Squares	Martellacci	Montville	MS – PL tip
18	Belles & Beaux Mountain Squares	Foote Landi	Glen Rock Whippany	MS – PL tip A2
20	Hunterdon Flutter. Middletown Ramblers Reelers Tenakill Twirlers	Kerns Foote Landi/Kushla Koft	Stanton Station Leonardo Randolph Cresskill	MS/PL PL PL/RD MS – PL tip
22	AleMo Squares	Richman	Brooklyn, NY	MS/PL – A tip
23	Spinning Wheels	C. Hardy/Gesumaria	Oakland	MS/CW – PL tip
24	Lakeland Squares	Koft	Montville	MS – PL tip
27	Circle Eights	Richman	Haworth	MS – PL tip
28	Western Wheelers	Landi/Millar	Oradell	PL/RD – A tip
29	Motiv8ors	Fellegly	Elmwood Park	A2/C1
30	Spinning Wheels	Leber/Gesumaria	Oakland	MS/CW – PL tip

December

1	Lakeland Squares	Richman	Montville	MS – PL tip
2	Belles & Beaux Mountain Squares	Applegate Landi	Glen Rock Whippany	MS – PL tip A2
4	Hunterdon Flutter. Middletown Ramblers Reelers RocklandRockytops	Cioy Landi Anfinsen/Pickett Richman	Stanton Station Leonardo Randolph W. Nyack, NY	MS/PL PL PL/RD PL – A tip
6	F.A.D. Squares GSSD Campers Motiv8ors Rutgers Promenaders	Koft Williamson/Williamson Ritucci Gottas & Kofts	Paramus Paterson Elmwood Park No. Brunswick	MS – PL tip PL/RD – A tip A2/C1 MS/RD
7	Spinning Wheels	Coy/Gesumaria	Oakland	MS/CW – PL tip
8	<i>Lakeland Squares</i>	<i>Wadel</i>	<i>Montville</i>	<i>Student Dance</i>
9	Cross Trail Squares	Landi	Caldwell	MS/PL – A tip
11	Bee Sharps <i>Kittatinny Rangers</i> Middletown Ramblers RocklandRockytops Y Squares	TBA/Bradt <i>Snyder</i> Matthew Gotta Reardon/McCabe	Bound Brook <i>Andover</i> Leonardo W. Nyack, NY Clark	MS/PL/RD – A tip <i>Student Dance</i> PL MS – PL tip MS/PL/RD
12	Western Wheelers	Snyder/Millar	Oradell	PL/RD – A tip
13	AleMo Squares	Coy	Brooklyn, NY	MS/PL – A tip
14	Spinning Wheels	Richman/Gesumaria	Oakland	MS/CW – PL tip
15	Lakeland Squares	Snyder	Montville	MS – PL tip
16	<i>Belles & Beaux</i> Mountain Squares	<i>Wadel</i> Landi	<i>Glen Rock</i> Whippany	<i>Student Dance</i> A2
18	Hunterdon Flutter. Middletown Ramblers Reelers Tenakill Twirlers	Kerns Franks Jacobs/Pickett Applegate	Stanton Station Leonardo Randolph Cresskill	MS/PL PL PL/RD MS – PL tip
20	F.A.D. Squares Motiv8ors Rutgers Promenaders	Snyder Jacobs Gottas & Kofts	Paramus Elmwood Park No. Brunswick	MS – PL tip A2/C1 MS/RD
21	Spinning Wheels	C. & G. Hardy/Gesumaria	Oakland	MS/CW – PL tip
31	Circle 8s & W. Wheelers The Five Clubs Middletown Ramblers	Matthew Jacobs/Kushla	Oradell Springfield Leonardo	2 MS/1 PL MS/PL/RD PL

January, 2010

1	RocklandRockytops	Leber	W. Nyack, NY	PL – A tip
3	F.A.D. Squares	Richman	Paramus	MS – PL tip
	Rutgers Promenaders	Gottas & Kofts	No. Brunswick	MS/RD
4	Spinning Wheels	Snyder/Gesumaria	Oakland	MS/CW – PL tip
5	Lakeland Squares	Leber	Montville	MS – PL tip
6	Belles & Beaux	Leber	Glen Rock	MS – PL tip
8	Bee Sharps	Richman/Pickett	Bound Brook	PL/RD – A tip
	Kittatinny Rangers	Reardon	Andover	MS/PL
	RocklandRockytops	Felleggy	W. Nyack, NY	MS – PL tip
	Y Squares	Koft/Koft	Clark	MS/PL/RD
9	Western Wheelers	Gotta/Gotta	Oradell	PL/RD – A tip
10	AleMo Squares	L. Kopman	Brooklyn, NY	MS/PL – A tip
	NNJSDA Mid-Term	Class Teachers	Elmwood Park	Student Dance
11	Spinning Wheels	Leber/Gesumaria	Oakland	MS/CW – PL tip
12	Lakeland Squares	Patton	Montville	MS – PL tip
13	Cross Trail Squares	Gotta	Caldwell	MS/PL – A tip
15	Hunterdon Flutter.	Wadel	Stanton Station	MS/PL
	Reelers	Snyder/Pickett	Randolph	PL/RD
	Tenakill Twirlers	Richman	Cresskill	MS – PL tip
17	F.A.D. Squares	Martellacci	Paramus	MS – PL tip
	Rutgers Promenaders	Gottas & Kofts	No. Brunswick	MS/RD
19	Lakeland Squares	Martellacci	Montville	MS – PL tip
20	Belles & Beaux	Ingis	Glen Rock	MS – PL tip
22	Bee Sharps	Snyder/Kushla	Bound Brook	PL/RD – A tip
	Circle Eights	Ritucci	Haworth	MS – PL tip
	<i>Kittatinny Rangers</i>	<i>Applegate</i>	<i>Andover</i>	<i>Student Dance</i>
	Y Squares	Koft/Koft	Clark	MS/PL/RD
23	Western Wheelers	Applegate/Millar	Oradell	PL/RD – A tip
25	Spinning Wheels	Richman/Gesumaria	Oakland	MS/CW – PL tip
26	Lakeland Squares	Amor	Montville	MS – PL tip
27	Cross Trail Squares	Martellacci	Caldwell	MS/PL – A tip
30	NNJSDA	Reardon, Snyder/Booz	Caldwell	MS/PL/RD

February

2	Lakeland Squares	Leber	Montville	MS – PL tip
5	Hunterdon Flutter.	Kerns	Stanton Station	MS/PL
	Reelers	Leber/Pickett	Randolph	PL/RD
	RocklandRockytops	Gotta	W. Nyack, NY	PL – A tip
7	Rutgers Promenaders	Gottas & Kofts	No. Brunswick	MS/RD
9	Lakeland Squares	Wadel	Montville	MS – PL tip
10	Cross Trail Squares	Koft	Caldwell	MS/PL – A tip
12	Bee Sharps	Felleggy/Bradt	Bound Brook	PL/A/RD
	Kittatinny Rangers	Snyder	Andover	MS/PL
	<i>RocklandRockytops</i>	<i>Wadel</i>	<i>W. Nyack, NY</i>	<i>Student Dance</i>
	Y Squares	Franks/Gotta	Clark	MS/PL/RD
13	Western Wheelers	Woerner/Millar	Oradell	PL/RD – A tip
16	Lakeland Squares	Amor	Montville	MS – PL tip
19	Hunterdon Flutter.	Kerns	Stanton Station	MS/PL
	Reelers	Reardon/Pickett	Randolph	PL/RD
	Tenakill Twirlers	Koft	Cresskill	MS – PL tip
21	Rutgers Promenaders	Gottas & Kofts	No. Brunswick	MS/RD
23	Lakeland Squares	Martellacci	Montville	MS – PL tip
24	Cross Trail Squares	Jacobs	Caldwell	MS/PL – A tip
26	Bee Sharps	Franks/Denniston, McCabe	Bound Brook	PL/RD – A tip
	Circle Eights	Snyder	Haworth	MS – PL tip
	Kittatinny Rangers	Wadel	Andover	MS/PL
	Y Squares	Koft/Koft	Clark	MS/PL/RD
27	Western Wheelers	Koft/Koft	Oradell	PL/RD – A tip

Workshops at Every Dance

Circle Eights	first ¼ hour of dance	Haworth	PL
Cross Trail Squares	½ hour before dance	Caldwell	PL
Lakeland Squares	second ¼ hour of dance	Montville	PL
Mountain Squares	every dance as needed	Whippany	A2
RocklandRockytops	¼ hour before dance	West Nyack, NY	DBD
Spinning Wheels	first ½ hour of dance	Oakland	PL
Western Wheelers	½ hour before dance	Oradell	RD
Y Squares	one tip each dance	Clark	PL

Conventions, Festivals, Specials & Weekends

September

11-13 A2 Weekend at Red Bates Boonville, NY A2 – C1 tips
Rocky's

October

8-12 NE Callers School Ritucci, Poisson, Story, Manchester, NH Learn to call
Foote, Uebelacker Improve skills
16-18 Tumbling Leaves Bates, Harrison, Moger, Bennington, VT MS/PL/A1/A2/
Marriner, Marshall, Ritucci/Collipi, Bradt C1/C2/RD
30 **NNJSDA Callahan/ Denniston, McCabe Caldwell MS/PL/RD**

November

8 **35th NNJSDA Mini-Festival Biggerstaff, Franks, Bridgewater MS/PL/A/C/RD**
Gotta/Gotta

December

6 Campers Dinner Williamson/Williamson Paterson PL/RD – A tip
Dance
31 The Five Clubs Jacobs/Kushla Springfield MS/PL/RD
Circle Eights & Matthew Oradell 2 MS/1 PL
Western Wheelers
A2 Dinner Dance Ritucci, Stacy Colonie, NY A2 – C1 tips

January

10 **NNJSDA Mid-Term Class Teachers Elmwood Park Student Dance**
30 **NNJSDA Reardon, Snyder/Booz Caldwell MS/PL/RD**

February

28 *Mid-Winter Mania CCNJ Callers/Teachers Elmwood Park Student Dance*

March

8 Cross Trail Squares Williamson Paterson MS/PL
42nd Anniversary Dinner Dance

April

25 **NNJSDA Landi Elmwood Park MS**
Spring Fling

June

23-26 **59th National Square Dance Convention Louisville, Kentucky**

Kentucky with the Coys

Get to the 59th National in Louisville the **EASY** way.

**Take the singing, dancing, FUN tour bus led by
Don Coy back to his home state.**

For further details: **718-238-8825, nodyoc@aol.com**

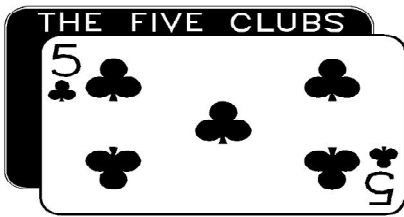

BEE SHARPS
RUTGERS PROMENADERS
Y SQUARES

NEW YEAR'S EVE DINNER DANCE

YMCA/CHISHOLM COMMUNITY CENTER
100 So. Springfield Ave. @ Shunpike Rd.
Springfield, NJ

THURSDAY, DEC. 31, 2009
7:30 PM – 12:30 AM

DELICIOUS BUFFET DINNER

Tickets: \$25/per person
Ticket sellers listed below

**DANCE FORMAT: ALTERNATING MS
& Plus, with Rounds**

CALLER: MIKE JACOBS

CUER: KAREN KUSHLA

FOR TICKETS, CONTACT:

AMMONS	908-763-0050	vammons@gmail.com
ROBINSON	908-963-2447	kenrbnsn@rbnsn.com
SANDERSON	908-233-2414	paulmsanderson@aol.com

NORTHEAST CALLERS SCHOOL

KEN RITUCCI NORM POISSON

(CALLERLAB ACCREDITED CALLERCOACH)

JERRY STORY ED FOOTE ANNE UEBELACKER

OCTOBER 8-12, 2009

**MILL-A-ROUND DANCE CENTER in MANCHESTER, NH
\$325/STUDENT**

Full CALLERLAB Curriculum - Plenty of microphone time
PROFESSIONAL ASSESSMENT OF YOUR SKILLS
Understand leadership – Develop career **BEST FOR YOU**

FOR AN APPLICATION AND MORE INFORMATION:

KENRITUCCI@AOL.COM or 413-734-0591

WWW.NORTHEASTCALLERSCHOOL.COM

SPACE IS LIMITED REGISTER TODAY



September – May	June – September	7:30 to 9:30 PM
Glen Rock Central School	Elmwood Park VFW	1 & 3 Wed
600 Maple Avenue	6 Veterans Place	
Glen Rock, NJ 07452	Elmwood Park, NJ 07407	Mainstream

Belles & Beaux Fall 2009

September 2	Mickey McFarland	Barn Dance – bring a friend
September 16	Wayne Applegate	Mad Hatter Tea Party
October 7	Howard Richman	World Series – hot dogs 4 all!
October 21	Wayne Applegate	Oh Baby – bring a picture!
November 4	Wayne Applegate	Karaoke – sing between tips
November 18	Ed Foote	Pie Night – yummy
December 2	Wayne Applegate	Flashlight – dangles 4 all
December 16	Fran Wadel	Holiday Student Dance
January 6	Roy Leber	It's Going Fast!!

Info – Audrey Kerner 646-275-4970 audrey.kerner@gmail.com

www.sqrdance.org/BellesBeaux Night of dance 646-275-4970

ARTICLES IN THIS ISSUE

Ad Makers/ Reporters Alert	39	National: Hunterdon Stars & Mercer ArcAngels	23
Bio: Dot & Don Coy	10	National: Louisville, 2010	44, 48
CCNJ News	6	NNJSDA	
Help for Area Clubs	14	Calendar of Events	4
Classes	6, 8	Club News Begins.....	16
Dance Calendar	56-60	Dancing at NNJSDA Events.....	12
Discount Printing at Office Depot.....	39	Event Maps.....	32, 51, 53
Event Announcement Email List.....	29	Host Clubs Thank You	18
Hand Washing for Health	30	New Format: Is It Working for You?	21
Hear-to-Dance	49	Presidents' Letter	3
Live Music Dance.....	11	Raids Completed	14
Money Saving Travel Tip.....	48	Pay It Forward	40

MASQUERADERS



FIRST BAPTIST CHURCH

125 South Main St., Hightstown, NJ

Pre-Rounds: 7:30 pm - Squares: 8:00-10:30 pm

Friday, September 4 Ice Cream Social

Alternating Plus & Mainstream Tips

Caller: Roy Leber Cuer: TBA

It's Our Last Dance.

Join us as we CELEBRATE our many years of wonderful dancing!

See page 40 for directions.

New Club Forming in the Mercer County Area.

Look for further announcements.

Contact Rich Delgado for membership information.

609-844-1140 richd1squarerounddancer@msn.com

ADVERTISERS' INDEX

*Please tell our advertisers that you saw their ad in **Grand Square**.*

A1 Class	43	NNJSDA Dances	3, 4, 9
A2 Weekend	37	Hardy, Chuck & Gerry.....	11
Acey Deuceys NYE A2.....	35	Hi Taws	47
AleMo Squares	42	Hunterdon Flutterwheels....	49
Bee Sharps	31	Kentucky with the Coys.....	60
Belles & Beaux	62	Kittatinny Rangers	39
Callers School.....	62	Lakeland Squares.....	25
Circle Eights.....	19	Masqueraders.....	63
New Year's Eve MS/PL....	19	Middletown Ramblers	13
Cross Trail Squares	7, 55	Mid-Winter Mania.....	6
F.A.D. Squares	30	Mini-Festival	33
Five Clubs NYE MS/PL/RD...61		Motiv8ors	41
GS Campers Dinner Dance ..17		Mountain Squares.....	14
		Reelers	21
		Plus Class.....	53
		RocklandRockytops.....	15
		Rutgers Promenaders	9
		Spinning Wheels	27
		Square D Fashions	11
		Tenakill Twirlers	12
		Tumbling Leaves.....	5
		Western Wheelers.....	29
		APD Plus Class.....	49
		New Year's Eve MS/PL ..	19
		Y Squares	23

NNJSDA MEMBER CLUBS

See club articles (alphabetically A-Z) and ads for further information. Advertisers' Index appears on the inside back cover. Clubs desiring to change dance night or location **MUST** contact the Recording Secretaries (listed on page 2) for clearance.

MAINSTREAM

Sunday	Weeks of the Month
F.A.D. Squares <i>c.c.oconnor@att.net</i>	1, 3 All Year
Rutgers Promenaders <i>kenrbnsn@rutgerspromenaders.org</i>	1, 3 Sept-June
Monday	
Spinning Wheels <i>dollyges@aol.com</i>	Every Week Sept-June
Wednesday	
Belles & Beaux <i>grandsquare1@aol.com</i>	1, 3 All Year
Friday	
Circle Eights <i>esmail@optonline.net</i>	4 Sept-June
RocklandRockytops <i>jgurumde@verizon.net</i>	2 All Year
Tenakill Twirlers	3 Oct-May

PLUS

Thursday	
Hix & Chix	Various June-Aug
Friday	
Middletown Ramblers <i>lorddouglasII@hotmail.com</i>	Every Week All Year
Reelers <i>rilimicy@optonline.net</i>	1, 3 Sept-June
RocklandRockytops <i>jgurumde@verizon.net</i>	1 Oct-June 3 July-Aug
Saturday	
Western Wheelers <i>rhoernlein@optonline.net</i>	2, 4 Sept-April

ALTERNATE MAINSTREAM/ PLUS

Sunday	Weeks of the Month
AleMo Squares <i>alemodancer@yahoo.com</i>	Various Sept-June
Tuesday	
Lakeland Squares <i>lakelandsquares@hotmail.com</i>	1,2,3,4 Sept-July
Wednesday	
Cross Trail Squares <i>kapnickrr@juno.com</i>	2,4 Sept-June
Friday	
Bee Sharps <i>beesharps@squaredancing.com</i>	2,4 Sept-May
Hunterdon Flutterwheels <i>kwiatek@att.net</i>	1,3 Sept-June
Kittatinny Rangers <i>lesh323@aol.com</i>	2,4 Sept-May
Y Squares <i>paulmsanderson@aol.com</i>	2,4 Sept-May
Saturday	
Five Clubs <i>vammons@gmail.com</i>	1,3 June-Aug

ADVANCED & CHALLENGE

Sunday	
Motiv8ors (A2, C1) <i>charartist@aol.com</i>	Various All Year
Tuesday	
Hi Taws (C1, C2) <i>bbeck123@aol.com</i>	Various All Year
Wednesday	
Mountain Squares (A2)	1, 3 Sept-Dec Mar-June

DANCES CANCELED

September	November	December	January
1 Lakeland	3 Lakeland	22 Lakeland	1 Hunterdon
4 RocklandRockytops	25 Cross Trails	23 Cross Trails	Middletown
8 Lakeland	27 Bee Sharps	25 All Clubs	Reelers
28 Spinning Wheels	Kittatinny	28 Spinning Wheels	18 Spinning Wheels
	Y Squares	29 Lakeland	

The Editors of *Grand Square* reserve the right to edit, correct, or otherwise modify articles or ad copy submitted for publication. Signed articles are the opinions of the authors and not necessarily those of the NNJSDA.

Check www.nnjsda.org for changes made after *Grand Square* is distributed.