

Grand Square

KEEPING THE SQUARE DANCE COMMUNITY INFORMED

NORTHERN NEW JERSEY SQUARE DANCERS ASSOCIATION

Vol. 53 - No. 1

Map Issue

Sept. 2010-Jan. 2011

SQUARE DANCING IS

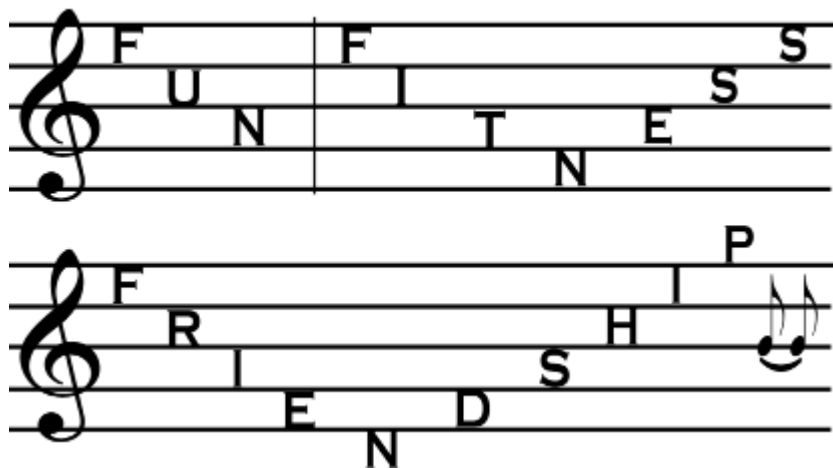

SET TO MUSIC!

COME JOIN THE FUN

September Is
National Square Dance Month

Cover design by Jan Thompson of Motiv8ors
NNJSDA Poster Contest Winner for 2010

Grand Square

KEEPING THE SQUARE DANCE
COMMUNITY INFORMED

EDITOR

Chris Beck Patrick
7 Black Watch Trail
Morristown, NJ 07960
Telephone: 973-998-4505
editor@nnjsda.org

Billing

Kay Davis

Production Staff

Rusty Ball Lise Greene

Proofreading

Don Schlesinger
Emily Tims Rick Blaine

Transportation

Jim Van Rensalier

Send articles and ads to editor@nnjsda.org.

Payment Due with Ad

Make all checks payable to NNJSDA.
Send checks to NNJSDA Treasurer.

Published 3 Times a Dance Season

Print Circulation: 1,100

Online at: www.NNJSDA.org

Subscriptions: \$12 for 3 issues

Deadline	Due Out	Theme
Nov. 7	Jan. 9	Winter/Spring
March 7	April 30	Grads/Summer
July	Aug. 24	Maps/Classes

ADVERTISING RATES

Actual Size Necessary for Camera-Ready Ads*	Sent by Email	Sent by USPS
Full 4 3/4" W x 7 1/2" H	\$55	\$60
1/2 4 3/4" W x 3 3/4" H	30	35
1/4 4 3/4" W x 1 3/4" H	15	20
1/8 4 3/4" W x 1.0" H	10	15

Discounts for prepayment of 3 ads – contact editor.

The following extra charges may apply:

Creating ad from hard copy	\$20
Corrections, sizing, etc.	5
Fee for billing	2

***Please email Word documents only.**
Use largest type to fit size.

NNJSDA EXECUTIVE BOARD, 2010–2011

Executive Committee

President: 133 New Jersey Ave., Lake Hopatcong, NJ 07849 973-663-4396 president@nnjsda.org	Lise Greene president@nnjsda.org	Assistant Treasurer: 973-697-7765 asst-treasurer@nnjsda.org	Kay Davis asst-treasurer@nnjsda.org
614 Van Liew Ct., Hillsborough, NJ 08844 908-963-2447 president@nnjsda.org	Ken Robinson president@nnjsda.org	973-627-1896 asst-treasurer@nnjsda.org	Sigrid Eisele asst-treasurer@nnjsda.org
1st Vice President: 908-852-9285	Donna Poyer firstvp@nnjsda.org	Past President: 973-838-0312	Rusty & Richard Ball past-president@nnjsda.org
2nd Vice President: 201-612-0856	Audrey Kerner secondvp@nnjsda.org	Appointees/Liaisons	
201-385-5696	Barbara Berger secondvp@nnjsda.org	Grand Square Editor: See contact information above.	Chris Beck Patrick
3rd Vice President: 973-618-9025	Alice DeLancey thirdvp@nnjsda.org	Insurance: 908-852-9285	Mike Szekula insurance@nnjsda.org
917-693-1469	Bill Flynn thirdvp@nnjsda.org	Webmaster: 908-963-2447	Ken Robinson webmaster@nnjsda.org
Recording Secretary: 201-722-0488	Jeanne Weisman recsec@nnjsda.org	Advisor/Trustee: 973-427-2889	Georgi & Richard Flandera trustee@nnjsda.org
Corresponding Secy: 973-731-1249	Eleanor & Steve Frank corsec@nnjsda.org	718-351-9150	Barbara & Norman Kanter trustee@nnjsda.org
Treasurer (Acting): 52 Kiel Ave., Kinnelon, NJ 07405 973-838-0312	Rusty Ball treasurer@nnjsda.org	732-494-8871	Judy & Al Kendziora trustee@nnjsda.org
		CCNJ Liaison: 973-857-8879	Ruth Edison & Ron Kapnick kapnickrr@juno.com
		Education/Gathering:	Rusty Ball

From the computers of... **Lise Greene & Ken Robinson, NNJSDA Co-Presidents**



In June, there was a “changeover” meeting with all the NNJSDA outgoing and incoming officers. Thank you to those who served the Association faithfully during the past year(s) and are not continuing on the Board: Jeanne Gannon, Greg Fokszey, Jan and Louis Thompson, and Shirley and Dick White. And a big welcome to the new Board members: Barbara Berger, Alice DeLancey, Billy Flynn, Jeanne Weisman, Eleanor and Steve Frank, and Chris Beck Patrick. Some of last year’s Board members have moved to new positions on the Board this year. Please check page 2 of this issue for a complete listing of officers and other Board members. On the website, you will find photos and contact information for all of us (nnjsda.org/whoswho.php).

A special welcome is extended to Chris Beck Patrick, our new editor. We are delighted that she has taken the helm with the help of a team of experienced and new assistants. Chris and her husband, caller Michael Patrick, are members of Reelers.

Last year, the NNJSDA Executive Board “raided” every club that completed the One Square Is Fair program, which requires a club to have at least eight members at a designated number of Association dances during one season. The six clubs that earned the award (and a dues reduction) in 2009 repeated their accomplishment in 2010 – congratulations! Completing our highlighting of those six clubs, we will feature Kittatinny Rangers and Bee Sharps.

Kittatinny Rangers (Mainstream/Plus) – The drive to Andover in the northwest corner of our dance region was well worth the trip, and not only because the club’s method for assigning refreshment duties ensures a delectable variety on the crowded table! Some of the enthusiastic new dancers have already taken on leadership roles that complement the work of other club officers, several of whom are also NNJSDA Board members. They have implemented new ideas on recruitment and retention and have more in the works. Congratulations to Bob and Francine Leshnow for their term as presidents, and to Stan and Georgia Tyburski for their work as class coordinators.

Continued on page 5

Northern New Jersey Square Dancers Association

Caller
Alternating MS/PL
Early Mainstream at 7:30

Butch Adams (VA)

Round Dance Cuer

Jane Styer (PA)

Dance Date/Time

**Saturday, October 30, 2010
8:00–10:30 pm**



Location

**St. Aloysius Church, Caldwell
Map on page 56**

Inquiries

**Donna Poyer: 908-852-9285
Night of Dance: 908-619-2296**

NNJSDA CALENDAR OF EVENTS

September

- 12 **Delegates Meeting** (12:30)
Elmwood Park, VFW
NNJSDA Dance (All MS 3:00)
Hass

October

- 9 **The Gathering** (MS/PL/RD)
New Brunswick, Douglass
Marshall/Pickett
30 **NNJSDA Dance** (MS/PL/RD)
Caldwell, St. Aloysius
Adams/Styer

November

- 7 *Grand Square* Deadline
Winter/Spring Issue
14 **NNJSDA 36th Mini-Festival**
Bridgewater School (tentative)
Story, Matthew, Ritucci/Gotta

December

- 4 NNJSDA Exec. Board Meeting

January 2011

- 9 **Delegates Meeting** (1:00)
Caldwell, St. Aloysius (tentative)
Grand Square Distribution
NNJSDA Mid-Term Dance
(Student Level 3:00)
Class Teachers
29 **NNJSDA Dance** (MS/PL/RD)
Rockaway (2:00) (tentative)
Franks/Wagenhoffer

March

- 5 NNJSDA Exec. Board Meeting
7 *Grand Square* Deadline
Summer Issue

April

- 30 **Delegates Meeting** (1:00)
Elmwood Park, VFW
Grand Square Distribution
NNJSDA Dance (MS/PL/RD 3:00)
McGovern/Kushla

May

- 21 **NNJSDA Dance** (All PL/RD)
Caldwell, St. Aloysius (tentative)
Shipman/Cuer TBA

June

- 1 Questionnaire Deadline
12 NNJSDA Exec. Board Meeting
22-25 NSD Convention: Detroit, MI

July

- 7 *Grand Square* Deadline
Maps/Classes Issue
13 **NNJSDA Dance** (MS/PL)
Hass
27 **NNJSDA Dance** (MS/PL)
Reardon, Snyder

August

- 10 **NNJSDA Dance** (MS/PL)
Russell
14 NNJSDA Exec. Board Meeting
24 **NNJSDA Dance** (MS/PL)
Ritucci
Grand Square Distribution

September

- 11 **Delegates Meeting** (1:00)
30 **NNJSDA Dance** (All MS)
Callahan

October

- 29 **NNJSDA Dance** (MS/PL/RD)

NNJSDA: ALL MAINSTREAM DANCE

Caller
All Mainstream

Dave Hass (CT)

Dance Date/Time

Sunday, September 12, 2010
3:00–5:30 pm

Location

VFW, Elmwood Park, NJ
Map on page 27 (see Belles & Beaux map)

Inquiries

Donna Poyer: 908-852-9285
Night of Dance: 908-619-2296





*Take pride in your outfit –
you'll be sure to turn heads!!*

Look and feel like a million bucks in a stylish new skirt from our exclusive Anne Draya line. We also carry many choices in separates and ensembles for gals, shirts/ties/jewelry for the guys, and plenty of accessories for men and women. We are a FULL SERVICE store and can supply all your dance fashion needs. Check out our website today:

www.SquareDFashions.com

Presidents' Letter continued from page 3

Bee Sharps (Mainstream/Plus/Rounds) – This club has many members who enjoy visiting other clubs and welcoming visitors to Bound Brook. The air-conditioned hall with a wood floor is an extra attraction, but of course the main draw is great dancing (and good food). Club presidents Ken and Kathleen Heaphy have provided excellent leadership in keeping the dances high-spirited. Class coordinators Bob and Diana Cole have brought in new dancers, many of whom continued from Mainstream to Plus. Some club members have also completed the Patron program, which encourages all dancers to visit other clubs. Thanks for your participation on several levels in NNJSDA.

While many of our member clubs are flourishing, a few are floundering. We were sad to bid farewell to two clubs last year – Masqueraders and Spinning Wheels. However, some new groups have formed, and we hope to welcome them as official members in the future.

The Executive Board is exploring various ways to publicize square dancing more effectively, and your ideas are welcome. One venue for sharing suggestions is at The Gathering on October 9, where timely issues will be presented by experienced square dance leaders who will share their success stories and brainstorm new approaches with the participants. In addition to getting ideas for their own club, attendees will receive a couple of bonuses: an attractive tote bag imprinted with square dance information that will catch the eye of passersby, and an evening dance with well-known caller John Marshall from Virginia and Mary Pickett cueing rounds. Please see pages 34 and 35 for detailed information on this very special event.

Lise Greene and Ken Robinson, NNJSDA Co-Presidents

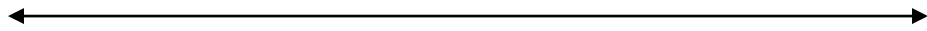

Letter to the Editor

We would like to thank you, our fellow dancers of the NNJSDA. Our 10-year tenure as *Grand Square* co-editors has given us many priceless friendships and memories. We were thrilled by the tremendous turnout at the Benefit Dance, a testimony to your appreciation of this fine publication. We will always treasure the engraved clocks that were presented to us that day. See you on the dance floor!

Jan & Louis Thompson and Barbara & Norman Kanter, Past Co-Editors

Grand Square Benefit Dance

When was the last time you danced with 23 squares in the hall? At Elmwood Park, no less?

That was the scene on Sunday, April 25, at the first *Grand Square* Benefit Dance. The enthusiasm of the dancers together with the sheer numbers made the event full of energy and excitement.



Photos by Ken Robinson

Joe Landi volunteered his calling talents, and Mary Pickett donated her cueing expertise, so all proceeds went to benefit *Grand Square*. Many people who could not attend bought tickets or made contributions to the cause. The final tally was more than enough to cover all expenses for a complete *Grand Square* issue.

Peg Tirrell (below), who served for 25 years as *Grand Square* editor with her late husband Doc, was honored during the dance.



Our recently "retired" editors (l-r: Louis and Jan Thompson, Norman and Barbara Kanter) were presented with engraved book clocks in appreciation of their 10 years of outstanding service.



Ken Robinson scanned and enlarged past *Grand Square* covers, and Jan Thompson mounted them for display around the hall. They evoked fond memories for many of the dancers.

Thanks to Joe Landi for sharing his wonderful idea, and to Mary Pickett for her valuable contribution. Thanks also to Jan Thompson, whose efforts as chairperson and registrar made publicity and ticket sales go smoothly.

Judy Kendziora, Benefit Dance Committee



Basic/Mainstream Class

Ironia Elementary School

303 Dover-Chester Rd. (Rt. 513)
Randolph, NJ 07869

**Introductory Dance Friday September 17 –
8:00 pm**

**Classes Start September 21, 2010
Tuesdays 7:30–9:30 pm**

Teacher: Mike Patrick \$50 complete program

Info: Bonnie and Charlie Van Stone 908-832-5313

TUMBLING LEAVES

20TH ANNUAL

FESTIVAL

OCTOBER 15, 16, 17 2010

BENNINGTON COLLEGE BENNINGTON, VERMONT

GREAT OUTSTANDING STAFF!!

CALLERS:

RED BATES
RANDY DOUGHERTY
BILL HARRISON
JOHN MARSHALL
DON MOGER
KEN RITUCCI

CUERS:

RALPH & JOAN COLLIPI
STEVE & IRENE BRADT

**A FULL
MAINSTREAM HALL!**



FIVE HALLS

THE ENTIRE FESTIVAL
PLUS, A1, A2, C1(Limited C2)
AND MAINSTREAM !!

- Round Dance Workshops
- Varied Packages Available
- Square Dance Shop
- RV Space on campus
- Campground nearby

CONTACT INFORMATION:

RED BATES

Nov-May: 5134 Latham Ter
Port Charlotte, FL 33981
941-828-0481

Jun-Oct: PO Box 1197
Rangeley, ME 04970
207-864-2524

E-MAIL: redbates@juno.com



2010–2011 BASIC/MAINSTREAM CLASSES

T = Teacher; CC = Class Coordinator's name, address, phone number, and email; TBA = To Be Announced. Changes may occur, so call to confirm starting dates and halls. Call Class Coordinators for details. Please notify the editor of any corrections. **Plus/Challenge classes listed on page 10.**

SUNDAY

Somerset – Rutgers Promenaders – Open House: Oct. 3, 1:30; Classes start: Oct. 17, 1:30 505 DeMott Ln., 08873; T = Betsy Gotta/Dan Koft; CC = Ken Robinson, 908-963-2447, kenrbnsn@rutgerspromenaders.org

Stanton Station – Hunterdon Flutterwheels – Open House: Feb. 13, 1:30; Classes start: Feb. 20, 2011, 1:30; The Lodge at Echo Hill Park, 43 Lilac Dr., 08822; T = Ed Kerns; CC = Joe Kwiatek and Donna Besignano, 908-526-7496, DonnaBes@att.net

MONDAY

Bridgewater – Bee Sharps – Open House: Sept. 13, 7:30; Classes start: Sept. 20, 7:30; Adamsville School, 400 Union Ave. (Rt. 28), 08807; T = Gardner Patton; CC = Ken Heaphy, 908-581-3897, Kathleen Heaphy, 908-526-4626, KHeaphy105@aol.com

Paramus – Circle Eights – Open House: Sept. 13, 7:30; Classes start: Sept. 20, 7:30; East Brook Jr. H.S., 190 Spring Valley Rd., 07652; T = Andy Woerner; CC = Anne Szabo, 201-845-8278, AnnCardone@yahoo.com; Suzanne Tillman, 201-529-8310, mastermind-teacher@fastmail.fm

Staten Island, NY – AleMo Squares (West) – Classes start: Sept. 13, 7:30; Eger Health Care Center, 140 Meisner Ave, 10306; T = Barbara Kanter; CC = Norman Kanter, 718-351-9150, bnkanter@verizon.net

Towaco – Lakeland Squares – Open House: Oct. 4, 11, 7:30; Classes start: Oct. 18, 7:30; Church of the Transfiguration, 9 Two Bridges Rd., 07082; T = Fran Wadel; CC = Eb & Judi Nordman, 973-334-5122; Kathy Keener, 973-366-8064, lakelandsquares@hotmail.com

TUESDAY

Caldwell – Cross Trail Squares – Open House: Sept. 28, 7:30; Classes start: Oct. 5, 7:30; Grover Cleveland M.S., 36 Academy Rd., 07006; T = Ron Kapnick; CC = Ruth Edison 973-239-2705, kapnickrr@juno.com

Clark – Y Squares – Open House: Sept. 14, 7:30; Classes start: Sept. 21, 7:30; Hehnly School, 590 Raritan Rd., 07066; T = Dan Koft; CC = George Kuhne, 732-548-8537, gkuhne@optonline.net

Leonardo – Middletown Ramblers – Open House: Oct. 1, 7:30; Thompson Park, Lincroft; Classes start: Oct. 5, 7:30, Henry Hudson Trail Center, 945 Rt. 36, 07737; T = Larry Sherwood, larryshrwd@gmail.com; CC = Betty Scharmann, 732-291-1188, bscharmann@comcast.net

Newton – Kittatinny Rangers – Open House: Sept. 21, 7:30; Classes start: Sept. 28, 7:30; Halsted Middle School, 59 Halsted St., 07860; T = Wayne Applegate; CC = Stan Tyburski, 973-383-2933, tyburski@embarqmail.com

Randolph – Reelers – Introductory Dance: Sept. 17 (Friday), 8:00. Classes start: Tuesday, Sept. 21, 7:30; Ironia Elementary School, 303 Dover-Chester Road (Rt. 513), 07869; T = Mike Patrick; CC = Bonnie & Charlie Van Stone; 908-832-5313, rms.373@hotmail.com

WEDNESDAY

Brooklyn, NY – AleMo Squares – Open House: Sept. 12, 7:30; Classes start: Sept. 22, 7:00; Our Lady of Grace Church, 430 Ave W, 11223; T = Don Coy; CC = Caroline Parlato, 718-745-3793, nodyoc@aol.com

Nanuet, NY – RocklandRockytops – Classes start: Oct. 6, 7:00; Nanuet High School Cafeteria, 101 Church St., 10954; T = Fran Wadel; CC = Patsy Lisak, 845-639-6816, jlisak9845@aol.com

Classes continued on page 10



CROSS TRAIL SQUARES

2nd & 4th Wednesdays 8:00-10:00

Plus Workshop: 7:30-8:00

Alt. Mainstream/Plus: 8:00-10:00

After Tip: 10:00-10:15

Grover Cleveland Middle School
88 Academy Road (@ Prospect St)

Caldwell, NJ 07006

(One block off Bloomfield Ave)

INFO: Ron Kapnick 973-857-8879
Dan Tapper 201-247-9476
At the hall 973-420-7149
www.crosstrailsquares.org

Where Fun
Meets
Friendship

FORMAT: ALTERNATING MAINSTREAM AND PLUS

Sept. 8	Don Coy	Back to School
Sept. 22	Howard Richman	Fall Fest
Oct. 13	Dan Koft	"Think Pink" (donate to S.Komen Foundation)
Oct. 27	Roy Leber	Halloween Bash
Nov. 10	Ed Foote	Turkey "Shoot"
Dec. 8	Joe Landi	Holiday Sharing (donate to food pantry)
Jan. 12	Nick Martellacci	Caribbean Night
Jan. 26	Michael Patrick	Presidents' Dance
Feb. 9	Betsy Gotta	Valentine's Dance
Feb. 23	No Dance — School Closed	

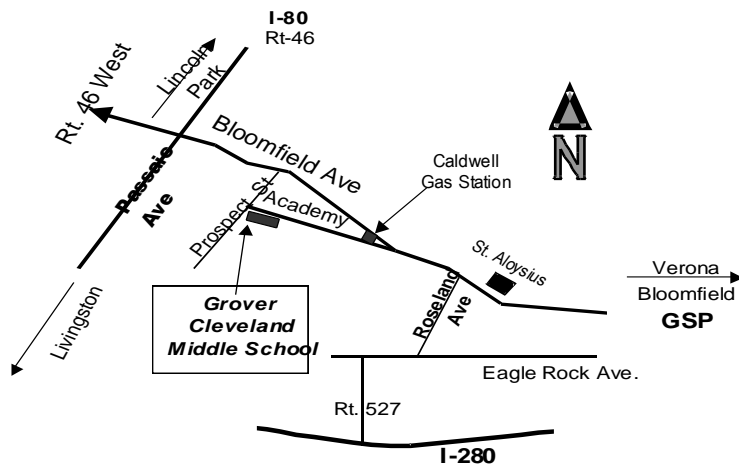

Letter from the Editor

I would like to extend a huge *THANK YOU* to Don Schlesinger, Rusty Ball, Lise Greene, Mary-Ann Ryan Erdek, and Jim Van Rensalier for their proofing, production assistance, guidance, and eagle-eyes. A very special thank you to Barbara and Norman Kanter and Jan and Louis Thompson for all of the above plus more than a little hand-holding! Without them, along with club article writers and ad makers, there wouldn't be a *Grand Square* publication. I'm sure a change or two was missed somewhere, but hopefully nothing too important.

If you are interested in joining the *Grand Square* "staff," please contact me at editor@nnjsda.com. The next deadline for *Grand Square* ad and article submissions is November 7, 2010. Until then, Happy Dancing!

Chris Beck Patrick, Editor

Basic/Mainstream Classes continued from page 8

THURSDAY

Glen Rock – Belles & Beaux – Open House: Sept. 16, 23, 7:30; Classes start: Sept. 16, 7:30; Glen Rock Central School, 600 Maple Ave., 07452; T = Fran Wadel; CC = Gloria & Michael Santolini, 201-396-1022, msanto@mail.com

PLUS CLASSES

Brooklyn, NY – AleMo Squares – Plus classes start: Sept. 23, 8:30 (Thursdays). See Wednesday Basics listing for details.

Newton – Kittatinny Rangers – Plus classes start: Oct. 5, 6:30 (Tuesdays). Halsted Middle School, 59 Halsted St., 07860; T = Wayne Applegate; CC = Stan Tyburski, 973-383-2933, tyburski@embarqmail.com

Oradell – Plus classes start: Sept. 16 (Thursdays); T = Andy Woerner. Call 201-261-1047 for details.

Montville – Lakeland Squares – Plus classes start: Sept. 14, 7:00 (Tuesdays). Senior House, 356 Main Rd., 07803; T = Fran Wadel; CC = Kathy Keener, 973-366-8064, lakelandsquares@hotmail.com

CHALLENGE CLASS

Oradell – Motiv8ors – C1 classes start: Oct. 3, 5:00 to 7:00 (Sundays). Borough Hall of Oradell, 355 Kinderkamack Rd., 07649. T = Daryl Murphy; CC = Chariss Smith, 201-489-2498 and George & LouEllen Stoms, 908-298-1851



The big smiles attest to the great time these New Jersey and New York dancers had at the National Convention. Three of the dancers made it a real "road-trip." Patsy Lisak of RocklandRockytops along with Linda Millian and Arlene Remington of Belles & Beaux spent three weeks traveling in Patsy's camper touring Pennsylvania, Ohio, and Kentucky, dancing along the way and loving every minute!

Rutgers Promenaders

2010–2011 Dance Season
1st and 3rd Sunday Afternoons
September 19 through June 5
2:30–5:00 pm
Franklin Township Senior Center
505 DeMott Lane
Somerset, NJ 08873
Family Friendly
Mainstream Dancing for All Ages

Callers: **Betsy Gotta**
and/or **Dan Koft**

Cuers: **Roy Gotta**
and/or **Kathy Koft**

Watch for information about our
Toys for Tots Dance in December

For more information
Ken Robinson

908-963-2447 (cell phone)
kenrbsn@rutgerspromenaders.org
<http://www.rutgerspromenaders.org/>

Northern New Jersey Square Dancers Association

Student Mid-Term
Dance

Callers: Class Teachers

Come support our newest dancers!

Dance Date/Time

Sunday, January 9, 2011
3:00 pm (after Delegates Meeting)



Location

St. Aloysius Church, Caldwell (tent.)

Inquiries

Barbara Berger: 201-385-5696

Gently used square dance attire will be available for sale.

[This is part of the series of articles highlighting people active in the NNJSDA.]

Lise Greene and Mark Bippes



Two ideals, learning and serving, weave through the lives of Lise and Mark. Lise, who grew up in Nutley, NJ, graduated from Montclair State University with a BA in English. Mark, raised in Rochester, NY, completed a BS in Mathematics at Albright College, and then spent five years in full-time Christian youth work. Their lives intersected at Moody Bible Institute, where they had both enrolled in the graduate school.

They ended up in the same five classes in the first semester! They married the following year. Both later completed an MA in Counseling at MSU.

After completing their master's degrees, they thought it would be fun to continue taking courses for pleasure instead of a degree. In 1981, they took Mainstream lessons sponsored by Warren Wheelers (a club they joined), followed by NNJSDA-sponsored Plus lessons over the summer. In 1988, they began round dance lessons with Al and Gale Spinks. Upon moving to Lake Hopatcong, they joined Sussex Spinners. Mark and Lise joined Reelers in 2001, where they have served as refreshment chairs, raid chairs, treasurer (Mark), secretary and newsletter editor (Lise). They are also members of Kittatinny Rangers, where Lise was reporter and ad maker. For the NNJSDA, they served as 3rd VP for Publicity for two years. Lise is currently in her second term as Co-President. However, Barbara Kanter, former *Grand Square* editor, has noticed, "Mark might not have his name up there, but whenever I see him, he's working."

Lise cites the first Kittatinny Rangers dinner dance she attended as her best dance experience. She enjoyed Johnny Preston's outstanding calling and mini-concert, as well as the delicious food, decorations, and tricky tray. Mark's favorite dance experience was at Western Wheelers this past season. "Howard Williamson was calling a very challenging Plus. There was one fun square in particular; we didn't break down, and it was the best tip ever!"

Just before they married, Mark took a summer job as a window installer, which eventually led him to establish his own construction company. He started volunteering with Habitat for Humanity in 1987 and became a full-time employee in 2000. After one and a half years in North Carolina, he became Construction Supervisor and Volunteer Trainer for Morris (County) Habitat for Humanity in New Jersey.

Lise went on to earn a PhD in Higher Education Administration at New York University. She was employed at Montclair State University for 25 years, the last 18 as Executive Assistant to the President. While Mark was in North Carolina, she spent a year in Denmark learning her mother's language in order to translate family diaries and letters into English (an ongoing project). Upon leaving MSU, she returned to Denmark to teach English for a semester, and then spent the following year in a graduate program to earn certification in Teaching English to Speakers of Other Languages. She also spent two years as a newspaper journalist and photographer. Currently, she is at Lehigh University in Pennsylvania as Presidential Writer.

Continued on page 15

Summer Square Dance Demos

Belles & Beaux performed a lively square dance demo at the Bergenfield Library in May with caller Fran Wadel. Participants included Bob Bachmann (Circle Eights), Barbara Berger, Brenda and Wayne Sherman, Rosann Flynn, and a member of John Callahan's senior group in Tenafly.

Fran explained to the audience how modern square dancing includes non-traditional music and songs, such as Broadway melodies, Disney songs, and other popular tunes. She then called in her sweet, lovely voice.

Some of her singing calls included "Walking My Baby Back Home," "Rocky Top," a Disney musical selection, and "Solomon Levi" ("Umpsy Daisy").

Fran had audience members participating in some of the tips. The audience included several pre-schoolers, ages 4–6, who had a great time dancing — especially when Fran directed them to "give a high-five" to the other dancers. And of course, the kids knew exactly what to do!

Other NNJSDA clubs also participated in demos over the summer at parades, festivals, the Monmouth Park racetrack (see article on page 54), the New Jersey State Fair/Sussex County Farm and Horse Show, and the Richmond County Fair.

Brenda Sherman (*allbrendacats@yahoo.com*)

What Moves Us?

Several NNJSDA dancers had the opportunity to dance and act in a commercial for an arthritis pain reliever following a casting call for square dancers from a professional agency. On short notice, dancers from New Jersey as well as New York and Pennsylvania auditioned in July at the agency on Madison Avenue in New York. Two Association dancers were hired – Paul Ingis (Belles & Beaux) as the caller and Hal Stoller (Reelers) as a lead dancer. Others were hired later as background dancers, but the featured square consisted of four actresses, two actors, and only two experienced dancers (Hal and a man from Philadelphia).

Paul said, "It was a lot of fun. In less than an hour, the actors and actresses were able to do a dozen calls quite well and they looked pretty good. I included Couples Promenade Halfway, Square Thru, Right and Left Thru, Veer Left, and Ferris Wheel, to bring them back to their corner. Thus, they were able to do a full singing call with only a small percentage of the Mainstream list."

The actual commercial was filmed on July 28 from 8 am to 4 pm. Paul described the commercial's three scenes. In the first, a woman is able to practice square dancing early in the day. In the second, she attends a dinner party. In the third, she enjoys an evening square dance. All of this is possible because of her pain medication, Vimovo: "What moves me," as she proclaims.

In addition to the featured square, extras were hired to sit at tables, and two squares danced in the background. That group had enough experienced dancers – including Hal's wife Irene and Paul's wife Joanne – to help the actors. In addition to calling, Paul was filmed teaching the main character some fine points of dancing.

"The number of people needed to produce the commercial was astounding," said Hal. "There were electricians, cameramen, wardrobe and makeup people, production and marketing people, and someone who sat outside in a truck running a generator."

Continued on page 46

Tenakill Twirlers

Bryan School — Cresskill, NJ 07626

51 Brookside Ave

3rd Fri. — Mainstream with 1 Plus tip—8:00–10:30

2010

Oct. 15 --- Roy Leber

Nov. 19 --- Howard Richman

Dec. 17 --- Wayne Applegate

2011

Jan. 21 --- Dan Koft

Feb. 18 --- Howard Richman

Mar. 18 --- NO DANCE

Apr. 15 --- Roy Leber

May 20 --- Dan Koft

Pres. Gloria Fodera

201-385-8869

www.sqrdance.org/Tenakill.Twirlers

Square Dance Competition

An open Mainstream square dance competition was held on Thursday, June 24, 2010, at the 59th National Square Dance Convention in Louisville, KY. Tony Oxendine and Randy Dougherty called for the 37 squares that had signed up to compete. We had the pleasure of being asked to fill in a square with dancers from the Buckaroos Club from PA. After a brief warm-up in which errors were not penalized, the competition began with one judge assigned to each square.

The judging was not on styling but on completing the execution of the call – being in the correct position with the proper partner. If the square broke down after a call, it was allowed to remain in the competition if the dancers repaired the square within 10 beats of the music. If unable to do so, the square received a yellow warning flag. A second mistake not repaired within 10 beats resulted in a “black flag,” and the square was eliminated.

Spectators from our club who were watching the competition said that we were in one of the last six squares on the floor; we were elated to have lasted that long! It was one of the highlights of the Convention for us. The winning square put on a fine show of expert dancing, and it was a delight to see them finish.

Peter & Sylvia Collette (Cross Trail Squares)

Lise Greene and Mark Bippes continued from page 12

Lise and Mark's only "child" is a pampered black cat named Spooky. They also adore their many nieces and nephews. They enjoy sailing, biking, canoeing, hiking, and playing tennis. Mark is very involved at his church as an elder, youth leader, and Sunday School teacher, and was a Scout leader for two of their nephews. Lise likes traveling (25 foreign countries so far), gardening, choral singing, and reading. Mark and Lise have volunteered with Habitat for Humanity and the Fuller Center for Housing, including a 100-mile walk from Paterson to Philadelphia to raise awareness and funds. Mark has taken many student groups on weeklong building projects and participated in several Jimmy Carter Work Projects, while Lise ran two Hoedown for Humanity fundraisers and volunteers as a writer and photographer. They have competed in several triathlons to benefit Special Olympics – Mark as an individual athlete (biking, canoeing, running) and Lise on a four-person team (as a canoeist). They both placed first in their divisions on occasion!

When asked what was the best thing she ever did, Lise replied, "I reconnected with my mother's family and culture by living in Denmark and learning the language. It was the best year of my life." Mark's response to the same question was, "I decided to become a Christian and live by the Golden Rule: Do unto others as you would have them do unto you." Both Lise and Mark exemplify living by this creed.

Jan Thompson

FIRST PRESBYTERIAN CHURCH
35 Church Street, Rockaway, NJ 07866

NNJSDA Dance: January 29, 2011
Mark Franks (NJ) and Rick Wagenhoffer (NY) MS/PL/RD

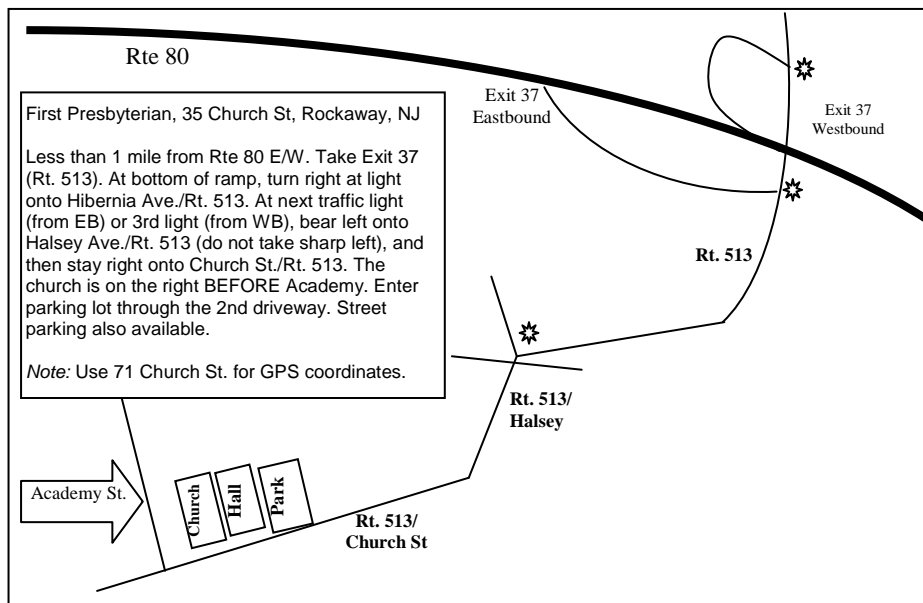

Middletown Ramblers

7:30–10:00 pm, Fridays

Croydon Hall, 900 Leonardville Ave., Leonardo, NJ 07733

www.middletownramblers.org

Sept. 10	Joe Landi	Nov. 5	Dennis Reardon
Sept. 17	Mark Franks	Nov. 12	Doug Kauffman
Sept. 24	Glenn Matthew*	Nov. 19	Ed Foote*
Oct. 1	Don Coy	Dec. 3	Dan Koft
Oct. 8	Dan Koft	Dec. 10	Gerry & Chuck Hardy*
Oct. 15	Mark Franks	Dec. 17	Mark Franks
Oct. 22	Butch Adams*	Dec. 31	Glenn Matthew NY Eve dinner dance – call for info
Oct. 29	Howard Richman		

Directions: GSP South to Exit 117. Rt. 36 approx. 8 miles to Academy Bus Depot. Turn right on Hosford Ave (light) and cross Leonardville Rd (stop sign). Make next left onto Bryant Ave. Bryant Ave. ends in the Croydon Hall complex. Dance hall is the last building on the right.

National Callers:

**Glenn Matthew, Butch Adams, Ed Foote,
Gerry & Chuck Hardy**

**Sept. 24 – Location: Ocean Avenue School
235 Ocean Avenue, Middletown**

**Open House – Open to the Public – Oct. 1
Thompson Park Barn, Newman Springs Rd., Lincroft**

**New Classes start Oct. 5, Tuesday nights, at
Henry Hudson Trail Activity Center 7:30–9:30 pm
Rt. 36 and Ave. D, Leonardo.**

Plus Club + Rounds

COST: Members \$3; Guests \$4 (refreshments are served)

* \$5 National Callers

NOTE: Hearing enhancement system available.

Ken Douglas, 732-581-4361 Betty Scharmman, 732-291-1188
Richard & Beverly Yackel, 732-747-8505

One Square Is Fair

Congratulations to the six clubs that completed OSIF in 2010:

Bee Sharps Belles & Beaux Circle Eights
Cross Trail Squares Kittatinny Rangers Reelers

Motiv8ors



NEW JERSEY'S PREMIER ADVANCED & CHALLENGE CLUB

Sundays at the Borough Hall of Oradell

355 Kinderkamack Road, Oradell, NJ 07649

C1 Program — 6:30–7:30 pm, A2 Program — 7:30–9:30 pm

Sept. 12 Ken Ritucci, MA Oct. 24 Dayle Hodge, MD

Sept. 19 Dayle Hodge, MD Nov. 7 Ken Ritucci, MA

Sept. 26 Ken Ritucci, MA Nov. 28 Todd Felleg, CT

Oct. 10 John Marshall, VA** Dec. 19 Todd Felleg, CT

****Special Schedule C1 2:30–4:30 pm, 6:30–7:00 pm A2 7:00–9:30 pm**

FOR ADDITIONAL DANCES, check our website motiv8ors.nnjdsda.org

Singles Welcome Casual Attire Computer Squares

Chariss & Carl: 201-489-2498, charartist@aol.com



CONGRATULATIONS, RAIDERS!

Eleven clubs completed the Raid program in 2009–2010.

BEE SHARPS BELLES & BEAUX CIRCLE EIGHTS

CROSS TRAIL SQUARES KITTATINNY RANGERS

LAKELAND SQUARES MOUNTAIN SQUARES REELERS

ROCKLANDROCKYTOPS WESTERN WHEELERS Y SQUARES

2010–2011 raids have already begun!

(Cross Trail Squares has already completed the program!!)

NOTE: THE RAID CHART MILEAGE HAS BEEN UPDATED.

Please use new mileage for future raids: www.NNJSDA.org_documents

Youth Square Dancing

“We need more dancers on the floor” is the refrain that we have been hearing for decades. The short-term solution is to recruit younger dancers, ages 30–50. The very long-term targets are the youth that will dance for a few years now, then possibly drop out and return later in life.

Historically, youth have been introduced to square dancing through family, 4-H, or schools. Decades ago, many of our clubs had youth groups. Many of our club members had teen and pre-teen children. Some were campers whose whole family square danced on weekends. Rutgers Promenaders was established for students on the college campus. Cross Trail Squares had a youth division that held its own dances. The popular misconception in the greater New York City area is that square dancing is for seniors. We gave up on the youth; they grew up and moved on, without being replaced. Our fault!

Many callers across the country are working very hard to keep their youth groups or establish new groups. The Northwest Youth Competition has been drawing 400–500 youth each of the last 40 years. Here in the Northeast, Betsy Gotta (NJ), Mike Callahan (NY), and Tom Miller (PA) currently have middle/high school programs. Each of them got started with a personal contact.

In pockets all across the country there are “Home School” groups that have discovered square dancing as an enjoyable way to satisfy the physical

education requirement. California has required each middle and high school to have a music and dance unit as part of physical education. Materials available to them are not interesting to the students; thus several callers are developing packages of music and instruction suitable for today’s youth.

It was discovered that introducing competition generates interest and enthusiasm similar to the “Dancing with the Stars” TV show. Currently, a committee in CALLERLAB is looking for schools that could be interested in a pilot program of competitive youth square dancing.

If you have contacts in a school, 4-H, or the Home School community, please send me their contact information and we will try to start such a program in this area.

Tom Miller has expanded from one to four schools in Pennsylvania and was told that he has now introduced 5,000 kids to square dancing. Some of their parents asked him to help them start a new adult club so that they could join the fun.

Consider: Tom Miller, Tony Oxendine, Tim Marriner, and Betsy Gotta all started as youth dancers, then youth callers. The internationally known callers of the future will be from the youth dancers/callers of today and tomorrow.

Join us at the September Delegates meeting to talk more about this important subject.



Ron Kapnick, President (KapnickRR@juno.com) 973-857-8879

RocklandRockytops

PLUS		MAINSTREAM	
First Friday - 8:00 to 10:15 PM (Third Friday in July & August)		Second Friday - 8:00 to 10:15 PM	
DBD Workshop - 7:45 to 8:00 PM		DBD Workshop - 7:45 to 8:00 PM	
A-1 Aftertip - 10:15 to 10:30 PM		Plus Aftertip - 10:15 to 10:30 PM	
		<i>Except Sept when there is a</i>	
		Public Introductory (ABC) Dance	
		From 7:30 to 8:30 PM.	
<i>No Dance</i>			
10/01/10	Mark Franks	09/10/10	Howard Richman *
11/05/10	Nick Martellacci	10/08/10	Jim Snyder
12/03/10	Ken Ritucci	11/12/10	Ed Foote
01/07/11	Todd Fellego	12/10/10	Roy Leber - <i>FREE DANCE</i>
02/04/11	Howard Richman	01/14/11	Betsy Gotta
03/04/11	Mark Franks	02/11/11	<i>Fran Wadel, Student Dance</i>
04/01/11	Ed Foote	03/11/11	Roy Leber
05/06/11	Rick Gittelman	04/08/11	Don Coy
06/03/11	Roy Leber	05/13/11	Ken Ritucci
07/15/11	Bruce McCue	06/10/11	Nick Martellacci
08/19/11	Betsy Gotta	07/08/11	Sandy Corey
		08/12/11	Howard Richman

*For Sept, Special Intro (ABC) Dance from 7:30 to 8:30 PM. Regular MS dance 8:30 to 10:30 PM (no Plus Aftertip). Angels are encouraged to attend the Introductory Dances.

Location: The Air Conditioned West Nyack Firehouse, 42 Strawtown Road, West Nyack, New York 10994

Singles Welcome

From New York State Thruway:

Take Exit 13S to Palisades Interstate Parkway. Go ½ mile to Exit 8E (Route 59 East). *(follow instructions below for Palisades Interstate Parkway)*

From Palisades Interstate Parkway:

Take Exit 8E (Route 59 East). Continue on Route 59 to first traffic light. Turn left onto Crosfield Avenue. Continue to end of Crosfield Avenue, turn right onto West Nyack Road and continue to traffic light. Turn left onto Strawtown Road. Firehouse is just past yellow blinker on the right.

From Kinderkamack Road (NJ):

Kinderkamack Road becomes Route 304 in New York. Follow Route 304 north to Route 59 (East). Turn onto Route 59 East. *(follow instructions above for Palisades Interstate Parkway)*

For further information:

David & Miriam: 845-354-6351

Mal & Dotty: 845-638-4393

Various Sun.

Sept.–June

Kathy Colucci: 718-375-1788

Our Lady of Grace Church

430 Ave. W at E. 4th St. 11223

Cell for dance night: 917-699-2039

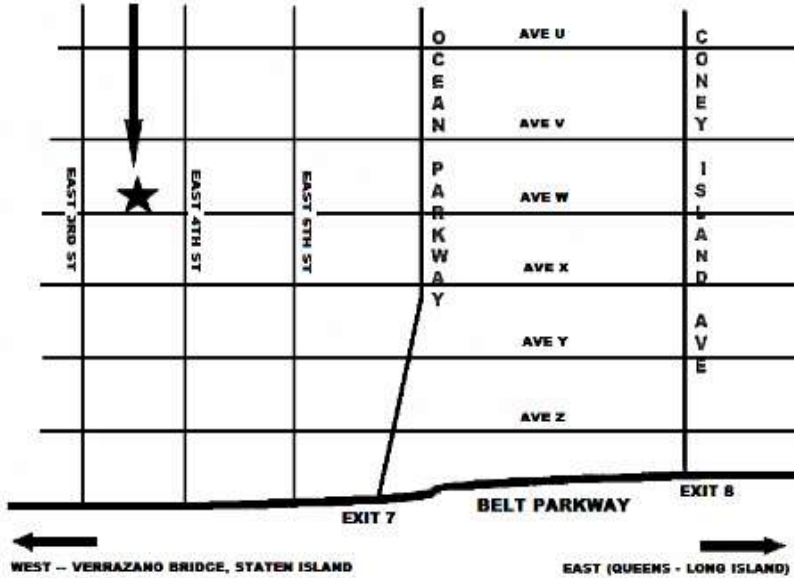

AleMo Squares hopes that all of the clubs in the Association had a wonderful summer and that they are refreshed and back for a banner year of square dancing. First we would like to get some personal business done. We would like to pay tribute to three members of AleMo who passed away over the past few months: Tom Doyle, who was instrumental in publishing the AleMo newsletter, Rick Kaye, and Dolores Kessler. They were all great members of our club and we miss them.

Our February Open House was hampered by brutally cold weather. Since this event feeds our student class size, we did not have a graduating class. We welcomed the eight Staten Island graduates into the square dance community and our club.

We have some ambitious plans for the rest of the square dance year and look forward to engaging with the other clubs in the Association. We hope for more new dancers from the August, Monday night ABC Dances on Staten Island.

Ad on page 48 Walter Lasky (*bklynadv@aol.com*) 718-996-5848

Advanced Class

Starts Monday, October 18, 2010 (6:30 to 8:00 pm)
 Carl Kumpf School, 59 Mildred Terrace, Clark, NJ 07066
 Advance Registration Encouraged
 Rich Delgado 609-844-1140 *richd1squarerounddancer@msn.com*

Circle Eights and Western Wheelers present

2010

NEW YEAR'S EVE DANCE

Catered Gourmet Hot Buffet
Great Fun, Food, Dancing, Friendship

SANDY COREY (NY) calling MS/PL

*Reformed Church of Oradell
641 Church Street (at Kinderkamack), Oradell, NJ
Friday, December 31, 2010*

**7:30 Doors Open 8:00 Dinner
Then Dancing till NEXT YEAR!**

\$30 per person



*No alcoholic beverages
Reservations in advance until Dec. 24
Call Bob & Hilda 201-664-4348 for more information*

✂----- cut here -----

Name: _____

Address: _____

City, State, Zip: _____

Phone: _____ Club _____

Email: _____ Dance Level? MS/PL

I would like _____ tickets at \$30 each Total amount enclosed:

\$ _____

Make checks payable to "Circle Eights" and mail to:
Bob & Hilda Bachman, 758 Chestnut Street, Washington Township, NJ 07676

BEE SHARPS – Bound Brook**MS/PL/RD-A tip**www.squaredancing.com/beesharps

PL/RD-A tip

2nd & 4th Fri. Sept.–Mid-Jan.

MS/PL/RD-A tip

2nd & 4th Fri. Late Jan.–May

Bob & Diana Cole: 908-874-8117

Bound Brook United Methodist Church

Cell for dance night: 908-763-0050

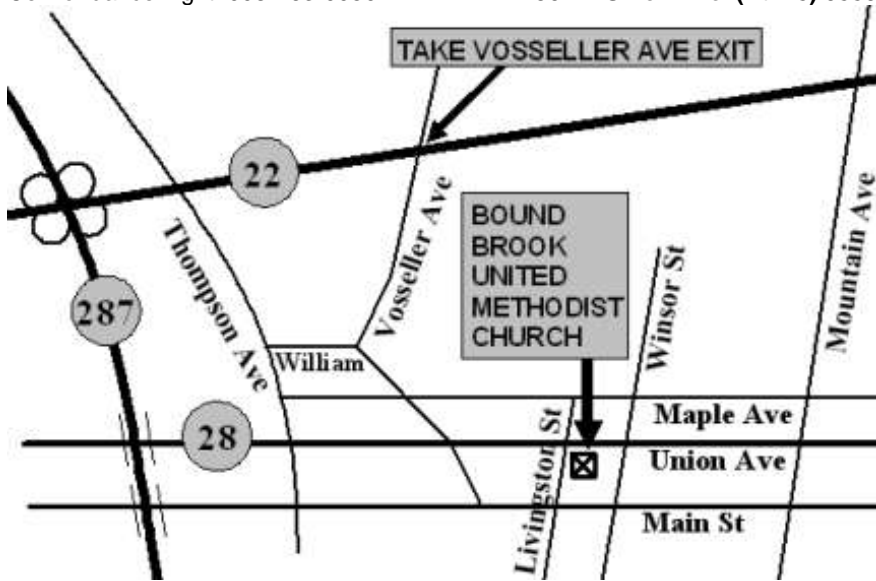
150 W. Union Ave. (Rt. 28) 08805

Last season Gardner Patton, our club caller/instructor, with assistance from new callers Wes Thielke and Joe Kwiatek, did a great job coaching 20 “solid” new Plus dancers to graduation in June. Congratulations to all new Plus graduates – Keep on Dancin’. The Bee Sharps had another fun year raiding the Middletown Ramblers, Hix & Chix, Reelers, Belles & Beaux, Hunterdon Flutterwheels, and Cross Trail Squares, and completed “One Square Is Fair.”

This Fall we will be dancing Plus from September to mid-January and then switching to alternating Mainstream and Plus from late January through May 2011.

An Open House is scheduled on September 13. Class begins on September 20, at the Adamsville School (400 Union Ave., Bridgewater, NJ 08807).

The Mainstream program will be completed in January, followed by a Plus class graduating in June. Tell your friends and then bring them to the open house.

Betsy Gotta is calling our scheduled Class Level Dance on January 28, 2011 to encourage student participation from all clubs.

A special thanks to the dedicated volunteers who made last year a success for the Bee Sharps – Kathleen and Ken Heaphy, Diana and Bob Cole, Nancy and Vic Ammons, Jane Ross, Joan Spagnolo, Irma Huhn, Cynthia Bartlett, Diane Coffman, Barbara and John Marlowe, Len Grasso, Alma Moore, Phyllis Perlowitz, and Holly and Bill Smythe.

Ad on page 38Curtis Kraut (curtis.kraut@gmail.com)

908-725-7411

Thank You, NNJSDA Host Clubs

Delegates Meeting - Sept. 12:

Reelers

Special Mainstream Dance - Sept. 12:

Circle Eights, Lakeland Squares, RocklandRockytops

NNJSDA Dance - Oct. 30:

Middletown Ramblers, Reelers, Rutgers Promenaders



CIRCLE EIGHTS

2010-2011

Mainstream Dances



Sept 24, 2010•Don Coy

Oct 22, 2010•Dan Koft

Nov 26, 2010•Howard
Richman

Jan 28, 2011•Roy Leber

Feb 25, 2011•Nick Martellacci

Mar 25, 2011•Dan Tapper

**Student Dance – students \$2*

April 29, 2011•Andy Woerner

**This is the 5th Friday*

May 27, 2011•Gerry Hardy

June 24, 2011• Dennis Reardon

★ **NEW YEAR'S EVE DINNER DANCE** ★

See ad on page 21

Dances: 4th Friday of each month (except July, Aug, & Dec)

8-10:30 pm Plus Workshop 8-8:15 Plus tip 9:15

First Congregational United Church of Christ

276 Haworth Ave., Haworth, NJ 07641

For more information: Nancy Stewart 201-664-7985

For directions on dance night call cell 201-696-1214

FREELoader

If you attended three of the four summer dances
and had your Freeloader Form signed,

Remember to get the final signature at the Mini-Festival on November 14.

Receive a dangle and a free ticket to a summer dance in 2011!

Form: nnjsda.org/nnjsda_documents

M R Square Dance Club

Dancing Selected 1st, 3rd, and 5th Fridays
and Saturdays

Look for Fliers and Announcements

Rich Delgado 609-844-1140

richd1squarerounddancer@msn.com



CCNJ met June 12, starting with a workshop about choreography. The workshop encouraged callers to bring examples of choreography that had unexpectedly confused dancers. The callers attending then analyzed the problem areas and suggested helping hints or changes to the choreography. CCNJ

offers a workshop/education session before each quarterly meeting to help both new and experienced callers increase their skills.

Looking to improve their skills, CCNJ callers Ron Kapnick, Barbara Kanter, and Fran Wadel attended callers' school before the 59th National Square Dance Convention. Also attending were 56 students, including eight youths (the youngest being 11 years old). A full quarter of the attendees were new callers with little or no experience.

Five CCNJ callers were among the local, regional, and national callers programmed at the convention. Our own Don Coy was a featured caller. Betsy Gotta worked all of the square dance halls as well as the contra hall. Other CCNJ callers programmed were Rich Delgado, Ron Kapnick, and Michael Winnick. Attending, but not programmed, were Fran Wadel, Barbara Kanter, and Dan Tapper. Betsy Gotta was also mentioned at the closing ceremonies as having attended 50 consecutive National Square Dance Conventions.

Look for some of the new CCNJ callers at the NNJSDA summer dances.

Betsy Gotta (ugottadance@optonline.net)

732-249-2086

Direct potential dancers to the following website:

You 2 Can Dance

www.You2CanDance.com

This website contains high-definition video clips of
SQUARE, ROUND, AND CONTRA DANCING
with professional voice-overs.

You can help promote Square, Round, and Contra Dance with
You 2 Can Dance.com



**Garden State Square Dance
Campers Association**



**Dinner Dance
Sunday, December 5, 2010**

11 AM to 4 PM

Caller: Howard Williamson

Cuer: Donna Williamson

Full Course Dinner: Roast Beef, Chicken,
Birch Beer, Wine, and Beer.

\$45 per person

NO Door Prizes!

Guests Welcome

**The
Brownstone House
351 W. Broadway
Paterson, NJ
Phone: 973-595-8582**

Directions

Route 46 East to Union Boulevard; North/Totowa/ Paterson (go under overpass) Take Union Boulevard until it dead ends at W. Broadway (2.8 mi); turn left on W. Broadway. Pass one blinker to traffic signal (about 4 blocks). Immediately beyond traffic signal, Brownstone is on left.

Route 80 West to Exit 55B (Totowa/Union Blvd.) Proceed as above.

Route 80 East to Exit 54 (Totowa / Union Blvd).At end of ramp turn left; proceed as above

Make checks in the amount of \$90 per couple (\$45 single) payable to GSSDCA and mail to:

George & Ria Pfersch, 13 Navaho Lane, Ft. Myers Beach, FL 33931
Reservations must be returned to the Pfersches by November 24, 2010

Name _____

Address _____

City _____ State _____ Zip+4 _____

Phone Number (including area code) _____



REELERS

Ironia School, 303 Dover-Chester Road
(Route 513), Randolph 07869

1st and 3rd Fridays

7:30 – Early Rounds

8:00 – Plus/Rounds

Info: Presidents Av and Bear Brady 973-347-1675

<u>Date</u>	<u>Caller</u>	<u>Cuer</u>	<u>Theme</u>
09/17/10	Fran Wadel	Mary Pickett	Introductory Dance
10/01/10	Glenn Matthew	Mary Pickett	African Safari
10/15/10	Jim Snyder	Mary Pickett	Fall Fruit Festival
11/05/10*	Joe Landi	Mary Pickett	Guess Who?
11/19/10	Dennis Reardon	Karen Kushla	Thanksgiving Food Drive
12/03/10	Len Anfinson	Mary Pickett	Cruise-Wear
12/17/10	Glenn Matthew	Mary Pickett	Cookies
01/07/11	Roy Leber	Mary Pickett	Baubles/Bangles/Beads
01/21/11	Jim Snyder	Karen Kushla	Chocolate Delight
02/04/11	Dennis Reardon	Mary Pickett	Super Bowl Party
02/18/11	Mark Franks	Mary Pickett	Pie and Presidents

*Location TBA

Class Information: Bonnie and Charlie Van Stone, 908-832-5313

Mainstream Class: Mike Patrick – Tuesdays, 7:30 pm
Ironia Elementary School, Randolph

MOUNTAIN SQUARES

Joe Landi, Caller – A2 (Workshop as needed)

7:45–10:00 pm

Our Lady of Mercy Parish Center

1st and 3rd Wednesdays

90 Whippany Road at Eden Lane

September–December, March–June

3rd light off Rt. 10

(No dance first week of September)

Information: Groth 973-746-0656

Roome 973-543-4109

The *Grand Square* cover, by this year's poster contest winner Jan Thompson, is available on the website as a Word document. Download and personalize it for your club's advertising needs (www.NNJSDA.org/postercontest/winningposter.php).

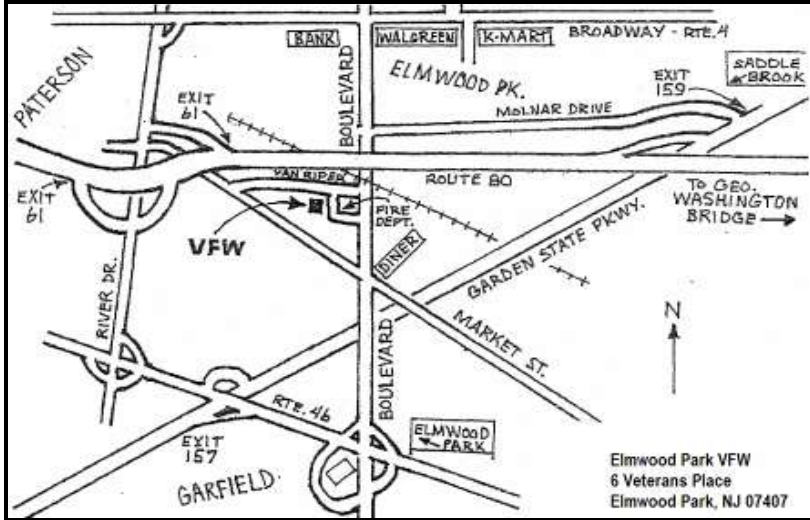

All had fun at May's Pajama Dance. Who could resist the appetizing array of breakfast food: pancakes with syrup, bacon, quiche, cantaloupe, and even a book of fairytales. Bedtime attire worn: pink jammies, scrubs, people with teddy bears. Caller Rick Gittelman wore a nightcap and slippers and sang "Dream Lover."

A bus full of dancers went on the May Mystery Bus Raid to Phillipsburg Manor in Tarrytown, NY. The evening was topped off by a dance at Friendly Squares in Katonah. True to their name, they were waiting to greet us when the bus arrived.

Thirteen brave square dancers participated July 5 in 90-degree plus heat in the Glen Rock parade. There was a barbecue and pool party afterwards at Chris O'Connor's house with 28 dancers attending. At the annual meeting, new officers were elected for the upcoming year: President: Maryjane Clewell, 1st VP, Amy Golden, and 2nd VP, Vicky Proskey (who will also be the Sunshine person).

We have graduated nine new members who are avidly attending dances.

Lastly, the club completed its raid card for 2010, thanks to enthusiastic raid chairs Maryjane, Joan, and Audrey.

Ad on page 43 Brenda Sherman (allbrendascats@yahoo.com) 201-387-0425

Patron Award Winners

Diane Coffman * Curtis Kraut * Karen Mallozzi * Carole Van Nahl
Phyllis & Larry Bugal * Jessica Wu * Charles Krueser * Doris Fera

4th-Time Patron Winners:

Sylvia & Peter Collette

They have all earned danglers and free Mini-Festival tickets.

CONGRATULATIONS TO YOU ALL!

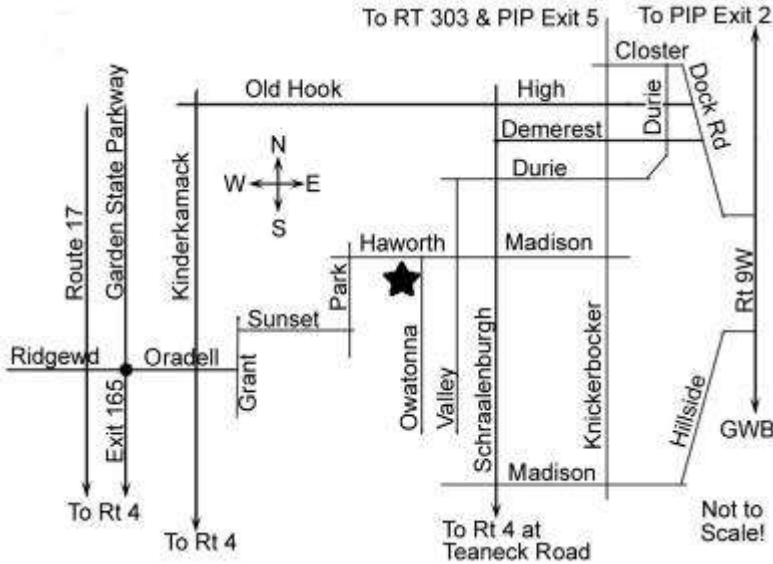

Many Circle Eights club members participated in and enjoyed the April 25 *Grand Square* Benefit Dance with caller Joe Landi. Another April highlight was the Maywood Street Fair at which Circle Eighters performed. Under the calling of Paul Ingis, dancers entertained the crowds, and many of them joined in, including a lively group of high school students.

Circle Eights was a hit at its spring raid of Spinning Wheels on May 17, as Mickey McFarland called the tips. In June, one square represented the club at the raid of Rutgers Promenaders. On May 28, Circle Eights had its annual potluck dinner followed by a dance called by Betsy Gotta. New club officers were voted in. The Co-Presidents are Carol Freemyer and Nancy Stewart, 1st VPs: Gerry Beatty and Rick Savino, 2nd VPs: Joan and Tom DeAngelis, 3rd VPs: Clare and Frank Messina, Secretaries: Barbara and Bob Graziano, and Treasurers: Rosemary and Gene Dunton.

Two festive June occasions were raiding Spinning Wheels as part of the new raid year and dancing at Circle Eights' annual Ice Cream Social on the 25th. Both Paul Ingis's calling and the scrumptious sundaes were pretty "cool"!

As in other summers, Andy Woerner gathered a group of club members together to march and square dance in the Oradell Fourth of July parade. Circle Eights was a patriotic people pleaser!

Ginny and Eric Mailman, former club presidents and beloved Circle Eighters, have moved to Delaware. Chris O'Connor hosted a barbecue for them in his lovely home where they were presented with a gift and heartfelt gratitude for all their service and friendship. The club will miss two valuable members of its family.

Ads on pages 21 and 23

Jeanne Weisman (Kreider99@aol.com)

201-722-0488

Y Squares

NEW DANCE NIGHT: 2nd & 4th Thursdays

Begins Sept. 23

Rounds @ 7:30 MS/PL Squares @ 8:00

Hehly School: 590 Raritan Rd., Clark, NJ 07066

Zion Lutheran Church: 559 Raritan Rd., Clark (alt. site)

Valley Rd. School: 150 Valley Rd., Clark (alt. site)

<u>Date</u>	<u>Theme</u>	<u>Caller</u>	<u>Cuer</u>
Sep. 14	Open House	Dan Koft	None
Sep. 23	Welcome Back	Dan Koft	M. Pickett
Oct. 14	Apple Fest	K. Ritucci	M. Pickett
Oct. 28	Halloween	Dan Koft	M. Pickett
Nov. 11	Thanksgiving (Food Bank)	B. Gotta	R. Gotta
Nov. 25	Thanksgiving	No Dance	
Dec. 9	Holiday (Bring a Toy)	Hardys	M. Pickett
Dec. 23	Christmas	No Dance	
Jan. 13	Winter Wonderland	Dan Koft	M. Pickett
Jan 27		W. Applegate	M. Pickett

Contact: Jan & Paul Sanderson 908-233-2414

◆————◆ NNJSDA Dancers at the National Square Dance Convention



NNJSDA dancers proudly displaying NJ state outfit colors at the 2010 National Square Dance Convention in Louisville, KY

CROSS TRAIL SQUARES – Caldwell

MS/PL

www.crosstrailsquares.org

2 & 4 Wed. Sept.–June Grover Cleveland Middle School, 36 Academy Rd. 07006

Ron Kapnick & Ruth Edison: 973-857-8879 Cell for dance night: 973-420-7149

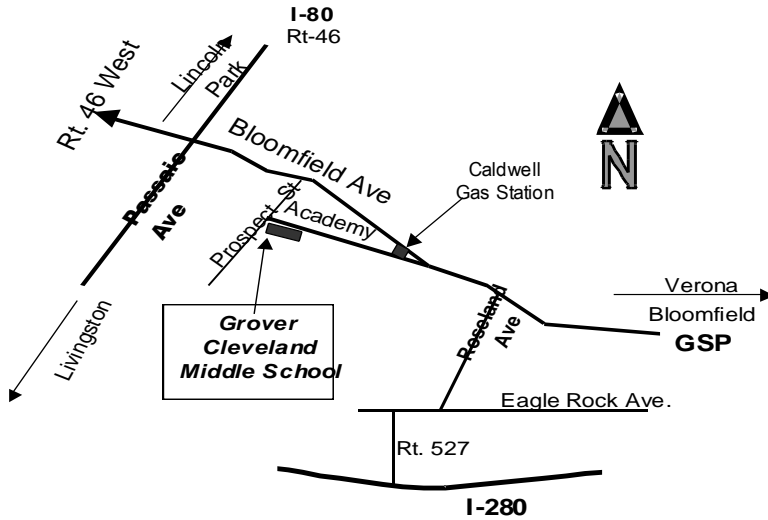

Cross Trail Squares finished the 2009–2010 season with several events, including our annual pie night on April 14. There were just too many choices, so the best course of action was to taste them all! We finished our lesson schedule on May 12, graduating a large class of 16 students. They all seem to be enjoying their new dancing skills, and have participated in many of the student dances. We then finished out the season with our annual ice cream social.

After lots of hard work and a couple of fun, well-attended raid seasons, Betsy Tapper has turned over the raid chairmanship to Sylvia and Peter Collette. Under their leadership, Cross Trails has already completed a significant number of raids and is well on its way to completing the requirement for this year. In another change for our club, Marie Ortega turned over the delegate’s position to Joan and Dennis Hanks.

Cross Trails was represented by nine members at the very successful national convention in Louisville, KY. Ron Kapnick and Ruth Edison attended the callers’ school before attending the convention, and we were excited to hear that Ron called a couple of tips in Kentucky! It seems the convention had something for everyone, from Mainstream on, including a “live music” hall, which drew a very large crowd.

We have met up with many friends over the summer at NNJSDA dances or club dances where they are fortunate to have an air-conditioned hall. As summer goes flying by, Cross Trails members are looking forward to beginning our new season with an Open House on the last Tuesday in September.

Ads on pages 9 and 61 Doris Fera (dor915@optonline.net) 973-887-3455

LAKELAND S

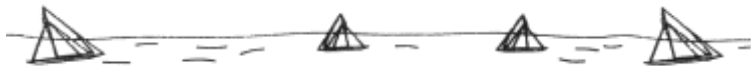

AIR CONDITIONED HALL

SENIOR HOUSE, 356 MAIN ROAD (ROUTE 202), MONTVILLE, NJ 07045

(Just off Route 287 Exit 47)

TUESDAYS 8:00 to 10:15 PM Alternating **MAINSTREAM & PLUS**

May through July

5th Tues: Barn Dances (8:00 PM)

Plus Class: From 7:00 PM–8:00 PM Call Kathy Keener to sign up for this class!

September 2010

- 7 No Dance – *Labor Day*
- 14 Gerry & Chuck Hardy
- 21 Howard Richman
- 28 Paul Ingis

October 2010

- 5 Jim Snyder
- 12 Roy Leber
- 19 Derek Page
- 26 Howard Richman – *Halloween Dance!*

November 2010

- 2 No Dance *Election Day*
- 9 Ed Foote
- 16 Mickey McFarland
- 23 Paul Ingis
- 30 Howard Richman – *Barn Dance*
Open to the public — Bring your friends!

December 2010

- 7 Dennis Reardon
- 14 Fran Wadel – *Student Dance*
- 21 Howard Richman – *Holiday Dance*
- 28 No Dance – *Happy Holidays!*

January 2011

- 4 Howard Richman
- 11 Dan Koft
- 18 Roy Leber
- 25 Michael Patrick

February 2011

- 1 Howard Richman
 - 8 Fran Wadel – *Student Dance*
 - 15 Paul Ingis
 - 22 Dan Tapper
-

Email us at:

Lakelandsquares@hotmail.com, or
Lakeland@squaredancing.com



For Info: Kathy Keener: 973-366-8064 (H)
(Night of the dance only): 973-229-0698 (C)
Or Sig: 973-627-1896

Visit our Website at
www.squaredancing.com/lakeland

F.A.D. SQUARES – Paramus & Maywood

MS-PL tip

Paramus Location: 1 & 3 Sun. All Year

(map below)

St. Matthew's Church, 167 Spring Valley Rd. 07652

Chris O'Connor: 201-797-6145

Maywood Location: 1 (MS) & 3 (PL) Thurs., 4th Sun. (Barn Dance) All Year

(map page 58)

Maywood Senior Recreation Center, Duvier Pl. 07607

Carol Freemyer: 201-880-6646

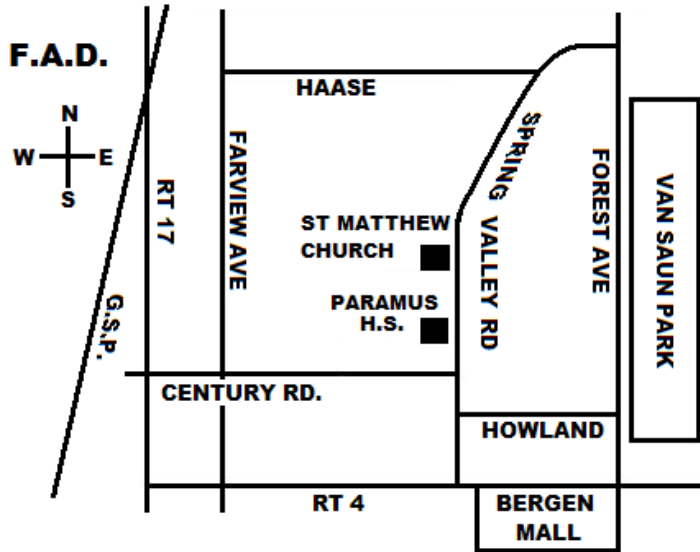

Everyone wants to have fun and be happy. That is the secret to a healthy life. Now you can do that easily and exercise your whole body and mind at the same time. All you have to do is come to a F.A.D. (Fun At Dancing) square dance on the 1st and 3rd Sunday of every month all year long.

But there is more good news — thanks to our Treasurers (Jim and Carol), we will now have a second F.A.D. square dance on the 1st and 3rd Thursday of every month at the Maywood Senior Center. The 1st Thursday will be Mainstream and the 3rd Thursday will be Plus.

A free Barn Dance will be held in Maywood on the last Sunday of each month starting August 29, 2010. Looking forward to seeing you at our dances.

Ads on pages 37 and 58

Doris Wilson

201-845-8294

Check out the Square Dance Video at

You2CanDance.com

See anyone YOU know???

HI TAWS – Paramus

C1/C2

www.nnjsda.org/Hi.Taw.Twirlers

Various Tues. All Year Paramus Senior Center, 93 Farview Ave. 07652
Sandy & Bernie Beck: 201-447-0538

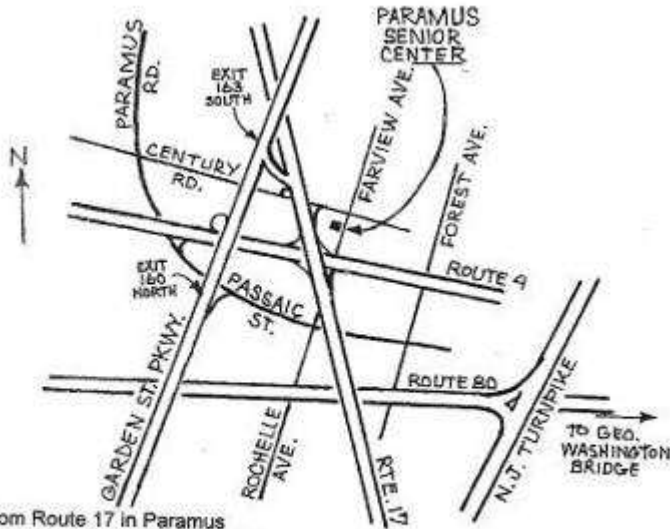

Directions: From Route 17 in Paramus turn east on Century Road to the first traffic light; turn right onto Farview Avenue and go about 100 yards. - Senior Center is on the right - parking in back

Ad on page 53

HIX & CHIX – Elmwood Park

PL/RD-A tip

www.hixchix.nnjsda.org

Various Thurs. June–Aug.

VFW Hall, 6 Veterans Pl. 07407

Hall Phone: 201-791-0765

Connie & John Huettemann: 201-438-0948

Map on page 27

Hix & Chix Summer Specials were off to a good start Thursday, June 10. A full house danced to the lively calling of old favorites Tom Miller (PA) and Bill Harrison (MD). On a slightly more sedate note, Regina and Rick Wagenhoffer provided the cueing for the round dancers.

On June 24 we welcomed an addition to our roster — Caller Mike Callahan (NY). (While we thoroughly enjoyed his calling, the floor was a bit sparse, with many of our regulars off to the National Convention in Louisville.) Karen Kushla was back, keeping our round dancers happy.

By the time this *Grand Square* is out, we will have provided four more Specials — hope you were able to enjoy them.

Dick & Brenda Dexter (bdexter@ups.com)

201-529-3372



Evolve or die—and thrive (Success stories from those who have effectively evolved and some of their strategies)

The real definition of **Evolve** is to grow, change, to undergo gradual change; develop. **Thrive** means flourish, prosper, succeed, increase, be healthy.

John Marshall Keynote Address: “Square Dancing and the 6 Senses – The Role They Play In the Activity and Its Promotion”

Breakouts:

“History and Horizons... Traditions and Techno in a New-Fangled World!”

By Howard Richman

- ✓ Many different aspects of square dancing from Traditional Music to Pop and House....
Traditional couples to the “we’re here to dance now get in a square!”
- ✓ Not being concerned (or judgmental) if they don’t “fit the mold” of traditional square dancers
- ✓ What does “judgmental” behavior look like and how can it be avoided?
- ✓ Presenting a wide variety of music for all ages/ groups — examples
- ✓ Attracting same-sex couples: 3 ways a club can be same-sex-friendly
- ✓ OK, you’ve attracted same-sex couples, now how do you make them feel welcome?

“Square Dancing is not a “Singles Activity,” but Solos Are Welcomed Here!”

By Eileen Okolowicz

- ✓ Attracting solos: Ways a club can be solo-friendly
- ✓ Solo dancing (OK, you’ve attracted solos, now how do you make them feel welcome?)
- ✓ Fashion “police” or open arms — dress code and lack thereof:
How to make wording for attire attractive and understandable — how to encourage suitable attire without requiring it?

“Growing the Square Dance Family”

By Dan Koft

- ✓ How do we get into the schools to introduce dancing?
- ✓ How do outsiders approach school district; what if school district approaches YOU, the dancer?
- ✓ Dancing with kids—what to do and what not to do to keep them coming back
- ✓ Attracting/encouraging families:
Factors that attract/prevent family participation (time of dances/classes on school nights, non-alcoholic, dancers who know how to deal with height and attention span issues)
- ✓ Home-schooling ins and outs; list pros and cons of home-schooling program
- ✓ How do outsiders approach the home-schooling network?

“Dancers with Limits—Together We Can All Have Fun”

By Michelle Mabie

- ✓ Declining dancers: How do we keep our loved ones involved?
Coping with physical problems — the halting step, one-handed dancer, failing sight and/or hearing, dancers with limited stamina needing to be replaced during a tip, etc.
- ✓ Including everyone at their own limits (not insisting everyone dance, but making it possible for them to dance when they want to and sit out when they want to do that)
- ✓ Using cultural awareness to promote square dancing (increasing diversity) — How to encourage different cultural groups to embrace American square dance?



The Gathering 2010

(Dancers Working Together
To Keep the Fun in Square Dancing)

October 9, 2010 12 noon-10 pm

"Evolve or die and thrive..."

Keynote Address by John Marshall (VA)

4 afternoon breakouts by presenters who have successfully evolved sharing some of their effective strategies

To top off an exciting day: Evening Dance
MS/PL: John Marshall, RD: Mary Pickett

Location: Douglass Campus Center (Rutgers)
100 George Street, New Brunswick, NJ 08901

Registration: \$15 per person

Free NNJSDA canvas tote bag for session attendees

*We honor families by admitting kids (through high school) for
half price when accompanied by a paying adult.*

Gourmet sandwich buffet during the dinner break:
\$10 additional (optional)

See *Grand Square Magazine* or www.NNJSDA.org for latest
information, map, and directions.

NJSquareDancers@verizon.net

973-725-9737

Registrar: Arlene Remington, 43 Kennedy Drive, Waldwick, NJ 07463

Name(s):	
Street Address:	
City, State, Zip:	
Club:	
Email:	Phone:
Registration: \$	Buffet: \$

Sponsored by Northern NJ Square Dancers Association,
Callers' Council of NJ, and Square Dance Council of NJ



All-Position

PLUS CLASS

with Andy Woerner

Thursdays starting 9/16/10

In Oradell, NJ Call 201-261-1047

IT WAS MURDER, SHE SAID IN GLEN ROCK . . .

Last April's "Murder on the Glen Rock Express" was a mystery-filled suspenseful evening, the 11th year, and "best one yet."

The wonderful cast and characters were Elsa Maxwell, the nasty hostess who gave fabulous parties (Linda Millian); Gladys Gigglepuss, the fumbling assistant (Amy Golden); Richard Worthington, shady Wall St. financier (Dan Wuerdeman of AleMo); Lucille McGillacutty, fading actress hoping to make a comeback (Margaret Kenter); corrupt Mississippi Senator Dory Calhone, who couldn't spell his home state (Mike Santolini); and Seymour O. Brown (S.O.B.), train porter/murderer (Richard Ball). Of course Law & Order was in attendance also — Detective Percy Periwinkle (Michael Gecht of AleMo) who, just like Sherlock Holmes, solved the murder!

At the end of the evening, the butler didn't do it — but all who knew her said that the victim (Elsa Maxwell) had it coming!

Train whistles were awarded to audience members who correctly guessed the evening's villain. *Choo, Choo!!* *Brenda Sherman (Belles & Beaux)*

ARE YOU CONNECTED BY USING THE EMAIL INFORMATION LIST?

If you *are* subscribed:

- You receive notices of upcoming dance events and changes.
- You can send such notices for your club.

If you are *not* subscribed:

- Send an email to webmaster@nnjsda.org and ask for an invitation.

If you have *new graduates*:

- Send their email addresses to webmaster@nnjsda.org. He will invite them to subscribe. Their addresses will only be retained if they accept the invitation.
-

ONE SQUARE IS FAIR

At least eight club members attend at least seven NNJSDA dances from June 2010 through May 2011.

Receive a reduction in your club's 2011 dues to NNJSDA!

Information: nnjsda.org/nnjsda_documents

F.A.D. SQUARES

"FUN AT DANCING"

Dancing: 7:30 pm to 9:30 pm

AIR CONDITIONED HALLS

PARAMUS LOCATION

1st and 3rd Sundays Mainstream with Plus tip

St. Matthew's Church, 167 Spring Valley Road, Paramus, NJ 07652

President Chris O'Connor 201-797-6145

September 5	Dan Tapper
September 19	Wayne Applegate
October 3	Roy Leber
October 17	Don Coy
November 7	Ed Foote
November 21	Wayne Applegate
December 5	Betsy Gotta
December 19	Jim Snyder
January 2	Howard Richman
January 16	Betsy Gotta
February 6	Roy Leber

MAYWOOD LOCATION

1st and 3rd Thursdays & 4th Sunday

Maywood Senior Recreation Center, Duvier Place, Maywood, NJ 07607

Carol Freemyer 201-880-6646

September 2	Howard Richman	Mainstream
September 16	Gerry Hardy	Plus
September 26	Wayne Applegate	Free Barn Dance
October 7	Dan Koft	Mainstream
October 21	Nick Martellacci	Plus
October 24	Howard Richman	Free Barn Dance
November 4	Dan Tapper	Mainstream
November 18	Roy Leber	Plus
November 28	Paul Ingis	Free Barn Dance
December 2	Roy Leber	Mainstream
December 16	Don Coy	Plus
December 26	-----	No Dance
January 6	Howard Richman	Mainstream
January 20	Dan Koft	Plus
January 23	Jim Snyder	Free Barn Dance

**Map to Maywood Senior Recreation Center
and additional F.A.D. ad on page 58**



BEE SHARPS OF SOMERVILLE

- **Early Rounds 7:30 pm**
- **Dancing & Rounds 8:00–10:30 pm**
See schedule below for dance format.
- **Possible Advanced final tip if sufficient Advanced dancers are present.**

OPEN HOUSE: September 13, 2010 from 7:30–9:30 pm at
 Adamsville School: 400 Union Ave (Rt.28) Bridgewater, NJ 08807
 Basic-Mainstream Lessons Start September 20, 2010

DANCE SCHEDULE 2010–February 2011

<i>Date</i>	<i>Caller</i>	<i>Cuer</i>	<i>Format</i>	<i>Theme</i>
Sep 10	Dennis Reardon	Steve Bradt	PL	Vacation T-shirts
Sep 24	Howard Richman	Mary Pickett	PL	On Broadway
Oct 8	Daryl Murphy	Sandy Godfrey	PL	Oktoberfest
Oct 22	Ken Ritucci	Steve Bradt	PL	Halloween Costume Party (prizes)
Nov 12	Betsy Gotta	Roy Gotta	PL	'50s Sock Hop
Nov 26	HOLIDAY	<i>Thanksgiving</i>		No Dance
Dec 10	Jim Snyder	Mary & Pete McGee	PL	Holiday Cookie Fest
Dec 24	HOLIDAY	<i>Christmas Eve</i>		No Dance
2011 Jan 14	Dan Koft	Mary Pickett	PL	International Night
Jan 28	Betsy Gotta	Roy Gotta	** MS/PL	**Class Level Dance Sing-Alongs
Feb 11	Glenn Matthew	Steve Bradt	PL/A2	♥ Sweethearts Ball ♥
Feb 25	Dennis Reardon	Mary Pickett	MS/PL	American Pie Night

Location: **Bound Brook United Methodist Church**
150 W. Union Avenue (Rt. 28) Bound Brook, NJ 08805
Contacts: **Bob & Diana Cole 908-874-8117**
Cell phone # for dance nights: 908-763-0050

DIRECTIONS:

From Route 22: Take Vosseller Ave exit to Bound Brook; left at light onto Union Ave. (Rt.28). * Follow 2/10 mile to Livingston Ave. Make right onto Livingston & left into first driveway/church parking lot.

From Route 287 South: Take exit 13 for Route 28 (Union Ave.) to Bound Brook/Somerville. Turn left at the light for Route 28 East. Proceed through 4 lights. After the 4th light follow from * above.

From Route 287 North: Take exit 13A for Route 28 East (Union Ave.), Bound Brook. Proceed through 3 lights. After the 3rd light follow from * above.

**** Visit us at: <http://www.squaredancing.com/beesharps> ****

HUNTERDON FLUTTERWHEELS – Stanton Station

MS/PL

www.hunterdonflutterwheels.njnsda.org

1 & 3 Fri. Sept.–June

Echo Hill Park Lodge, 41 Lilac Dr. 08822

Joe Kwiatek & Donna Besignano: 908-526-7496 Cell for dance night: 908-672-0372

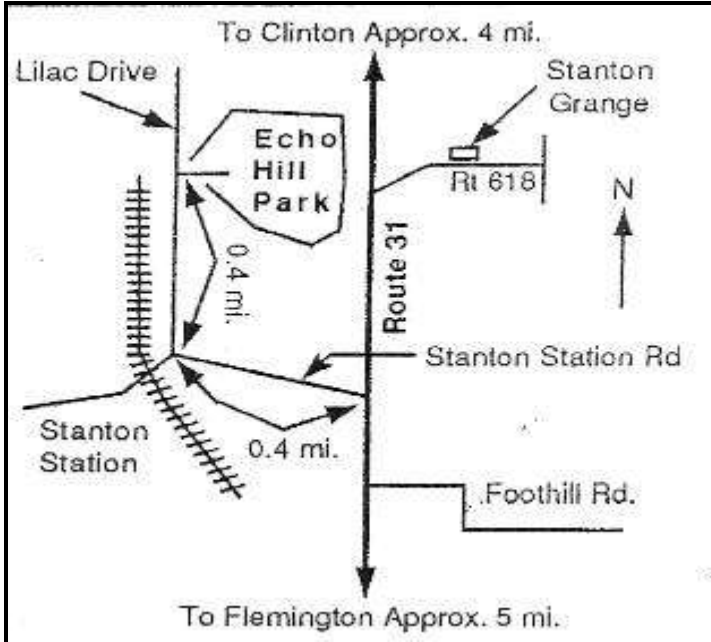

Congratulations to our Mainstream class, which graduated 16 new dancers this May. Thanks to the angels and students for their fortitude and determination. We are proud to have you all dancing on Friday nights.

Once again, many of our members volunteered to help the Hunterdon County Park System with the summertime “Music Under the Stars” program. We are also grateful for the combination of good friends and good food at the home of Peg & Fred Bailey, which made the Flutterwheel picnic a real success. We all look forward to this as a way of keeping in touch during the summer. In addition, the Bee Sharps and Flutterwheels put on a Mainstream dance July 31, for their newly graduated classes and experienced dancers. The club teachers, Ed Kerns and Gardner Patton, put on a good show and a good time was had by all.

It is a challenge to keep dancing during the summer, but the reward is great for those who are able to manage it. Pat and Don Elliott attended the National Square Dance Convention this summer in Louisville, KY. They rarely miss a convention. Many of our club members were able to visit other clubs that danced in air conditioning. However, we are always glad to get back to our regular dance schedule and our wonderful hardwood floor. Hope you can join us this coming dance season for fun and frivolity.

Ad on page 54

Peg Bailey (pegfredb@comcast.net)

908-574-5095

Map to the Mini-Festival

FOLLOW ROAD SIGNS VERY CAREFULLY

DIRECTIONS TO BRIDGEWATER-RARITAN MIDDLE SCHOOL
 FORMERLY - BRIDGEWATER-RARITAN HIGH SCHOOL - EAST

HALL TEL. NO. 908-526-9824

FROM RT. 80 EAST OR WEST
 Rt. 80 to Rt 287 South to Rt. 202-206 South (Exit 17) to Rt 22 East. Proceed 2 1/2 miles to FINDERNE Ave./Manville Sign. Turn right on FINDERNE Ave., pass light, and turn right onto Foothill Rd. Proceed 1.1 miles (you will go over Route 22) to Merrimwood Rd. Make a left onto Merrimwood Rd. Proceed into school driveway. Drive around school to side and front parking lots. No parking at yellow curbs. Park in lined areas only.

FROM RT. 78 EAST OR WEST
 Rt. 78 TO Rt. 287 South to Rt. 202-206 South and follow above directions.

FROM RT. 287 NORTH
 Rt. 287 North to Exit 13B (Route. 28 West). Go two (2) traffic lights and make a right onto FINDERNE Ave. At the next traffic light make a left onto Foothill Road. Proceed 1.1 miles (you will go over Route 22) to Merrimwood Road. Make a left onto Merrimwood Rd. Proceed into school driveway and drive around school to side and front parking lots. No parking at yellow curbs. Park in lined areas only.

36th ANNUAL



MINI-FESTIVAL



SUNDAY, NOVEMBER 14, 2010

2:00–9:00 pm

Tentative Location: Bridgewater-Raritan Middle School,
425 Foothill Drive at Merriwood Road, Bridgewater, NJ 08807

Jerry Story (NC)

**Glenn Matthew
(DE)**

**Ken Ritucci
(MA)**

Rounds by: **Roy Gotta (NJ)**

Star Promenade Square Dance Shop from Virginia

****** 3 Halls – MS, Plus, Advanced, with Rounds ******

Dinner Hour: ½ hour C1 and Rounds by Request

Bring box supper or eat out No cooking or warming devices

“ONE SQUARE IS FAIR” EVENT

Info: Rusty & Richard Ball 973-838-0312 Kay Davis 973-697-7765
Cell for Day of Festival 973-725-9738 or 973-725-9737



LIGHT Soft-Soled Shoes ONLY – NO Boots Allowed

For latest updates and directions: www.NNJSDA.org

We honor families by admitting kids (through high school) for half price when accompanied by a paying adult.

Mail to: Kay Davis, 23 Woodland Drive, Oak Ridge, NJ 07438

Name(s) _____	Club _____
Street _____	City _____
State _____ Zip _____	Phone _____ Email _____
Advance Remittance \$15 each (\$18 at the door) _____	\$ _____
1st-Time Badge \$ 3 each _____	\$ _____
2010 Bar \$ 1 each _____	\$ _____
TOTAL _____	\$ _____

PLEASE!!
Enclose a #10 SASE with your order.
Thank you.

New Year's Eve 2010 with

Betsy Gotta & Ken Ritucci



Calling A-2



Roy Gotta
on Rounds

Schedule

Social Hour: 7:30 - 8:30 PM

Dinner: 8:30 - 9:30 PM

Dancing: 9:30 - Midnight

C-1 Star Tips

The Evening Includes:

Catered Buffet Dinner
Champagne Toast at Midnight
The Dessert Break "To Die For"

Russian Orthodox Church
Sand Creek Road · Colonie, NY
(Albany, NY area)

Cost: \$60 per person / \$120 per couple

Space is Limited to 10 Squares · Register early

Contact Ken Ritucci · 413-734-0591 · kenritucci@aol.com

Welcome in 2011 with Ken, Betsy & Roy

September to September:

Elmwood Park VFW
6 Veterans Place
Elmwood Park, NJ 07407

1 & 3 Wed.
7:30 to 9:30 pm
Mainstream

Belles & Beaux Fall/Winter 2010

Sept 1	Dan Tapper	Tapper Tips
Sept 15	Ron Kapnick	In the Pink
Oct 6	Nick Martellacci	Italian Night
Oct 20	Howard Richman	Oktoberfest
Nov 3	Wayne Applegate	Apple Night
Nov 17	Ed Foote	The shoe is on the other foot
Dec 1	Fran Wadel	Crazy Hats — STUDENTS!!
Dec 15	Howard Richman	Happy Holidays!
Jan 5	Wayne Applegate	Ooo La La!

Info – Maryjane 551-206-7905

www.sqrdance.org/BellesBeaux
squaredancing123@gmail.com

Northern New Jersey Square Dancers Association

Caller
Alternating MS/PL
Early Mainstream at 7:30

Mark Franks (NJ)

Round Dance Cuer

Rick Wagenhoffer (NY)

Dance Date/Time

**Saturday, January 29, 2011
2:00–5:00 pm**



Location

**First Presbyterian Church (tentative)
35 Church St., Rockaway, NJ 07866
Map on page 15**

Inquiries

**Donna Poyer: 908-852-9285
Night of Dance: 908-619-2296**

KITTATINNY RANGERS – Newton

MS/PL

www.kittatinnyrangers.njnsda.org

2 & 4 Fri. Sept.–May Florence M. Burd School, 219 Newton-Sparta Rd. 07860
Barbara and Jay Ten Eick: 973-347-2959 Cell for dance night: 973-229-2401

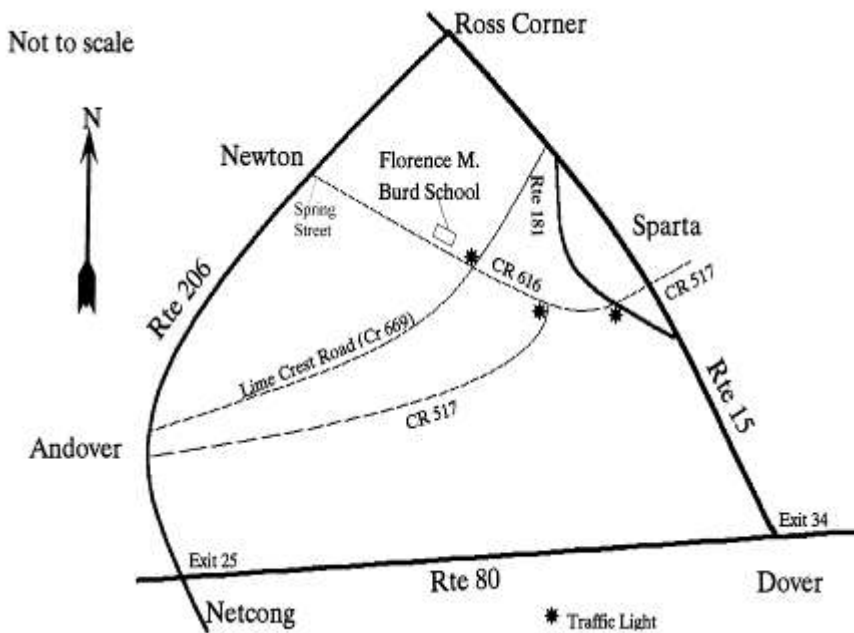

Kittatinny Rangers will be sponsoring both Mainstream and Plus classes this fall. Classes will be held on Tuesdays at the Halsted Middle School.
Ad on page 46

Callers' Council of New Jersey presents



Mid-Winter Mania

A special dance (featuring multiple callers) for all

DANCERS IN CLASSES (and angels)

Sunday, February 27, 2011, 2:30–5:00 pm

VFW Elmwood Park
6 Veterans Place, Elmwood Park, NJ

LAKELAND SQUARES – Montville

www.squaredancing.com/lakeland

MS/PL

MS/PL 1, 2, 3, 4 Tues. Sept.–July

Barn Dance 5 Tues. Sept.–July

Kathy Keener: 973-366-8064

Senior House

356 Rt. 202 (Main Rd.) 07045

Cell for dance night: 973-229-0698

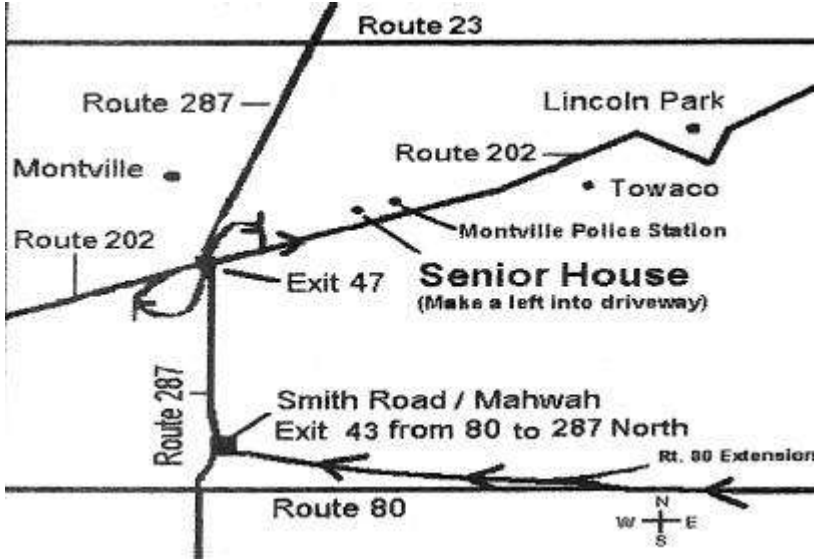

It was an interesting and successful season. Mainstream dancers from many clubs were attracted to dancing on the nights Paul Ingis called Mainstream between the tips. It also gave some of us a chance to dance nonstop the entire evening.

Attendance was excellent for our 37th anniversary dinner dance, our barn dances, and our June and July dances. Our barn dances have always been an opportunity for the community to experience square dancing. They have also served as a way to include children, nieces and nephews, and grandchildren. Barn dances that occurred on days when school was off provided many family outings.

We will begin a Plus class on September 14 for new students and Plus dancers wanting to brush up. Participants from other clubs are welcome. The class will start at 7:00 pm and end at 7:45. Fran Wadel will be the teacher. If you are interested in the class, call Kathy (973-366-8064) or email her at lakelandsquares@hotmail.com.

The scheduled dance will begin at 8:00. We will continue to provide more Mainstream and nonstop dancing by having either Paul Ingis or Wes Thielke come once a month to call Mainstream in between the tips.

Ad on page 31 Monte Montagnino (lakelandsquares@hotmail.com) 973-546-3092

You2CanDance www.you2candance.com

Club Presidents and Leaders:

Email: info@you2candance.com to have your club info included!

SQUARE DANCING FUN with the

Kittatinny Rangers

2nd & 4th FRIDAYS, 7:30–10:00 PM
MAINSTREAM & PLUS (ALTERNATING)



DATE	CALLER
September 10	Wayne Applegate
September 24	Dan Koft
October 8	Fran Wadel
October 22	Wayne Applegate
November 12	Dennis Reardon
December 10	Don Coy
January 14	Michael Patrick
January 28	Wayne Applegate
February 11	Dan Tapper

For Internet directions: Use 219 Newton-Sparta Road, Newton, NJ 07860

For more information: Jay and Barbara Ten Eick (973-347-2959)

Dance night: Donna Poyer (908-619-2296) or Mike Szekula (908-319-9412)

What Moves Us? continued from page 13

Hal and Paul agreed that the producers had a genuine concern for authenticity. “They wanted square dancing to be represented as accurately as possible and were willing to make changes to their plans and costumes to accomplish that,” said Paul. “I and the other dancers answered their questions and gave them advice and they listened intently.” Hal noted that the producers supplied new square dance outfits from a western wear store to ensure a good variety of colors and styles.

Hal described the filming: “There were large spotlights adding to the heat in the non-air-conditioned hall. We would dance for a minute or so, and then someone would holler ‘cut’ and everything stopped. After they moved some lights, cameras, or people around, we would repeat the process. Paul managed to mix up the calls to keep it fun and interesting. The most exciting part was when a cameraman got in the center of the featured square and we had to dance around him.” Paul then amused everyone by calling, “Heads promenade go half way round, down the middle with a right and left thru, turn that girl as fast as you can, don’t trip over the cameraman.”

Except for the extreme heat, the dancers were excited about being in a commercial. It will be shown on the Internet by the pharmaceutical company Astra-Zeneca. “In addition to promoting the new drug, maybe the commercial will promote interest in square dancing,” noted Hal. Yes – *that’s* what moves us!

Paul Ingis, Hal Stoller, and Lise Greene



Reelers
50th Anniversary Dinner Dance
Plus/Rounds

When? Sunday, April 10, 2011

12:00 cash bar (free cheese/crackers, veggies/dip)

12:30–4:30 pm Dinner and Dancing

Where? Zeris Inn

372 Route 46 East, Mountain Lakes, NJ 07046

Caller: Tom Miller Cuer: Mary Pickett

Dinner: penne vodka appetizer, tossed salad, choice of entrée (chicken marsala, salmon, prime rib), broccoli, stuffed baked potato, soda, coffee/tea, anniversary cake, ice cream

Cost? \$40 per person

Questions? Arlene and Tom Simansky 973-984-0009
arleneandtom@hotmail.com

Send registration and check by Sunday, March 20, 2011 to:
Bonnie and Charlie Van Stone
373 West Mill Road, Long Valley, NJ 07853

✂-----

Name(s) _____

Phone number _____

Address _____

Indicate entrée choice and number for each

____ chicken marsala ____ salmon ____ prime rib

Number attending at \$40 per person _____

Total amount of check made out to Reelers \$ _____

AleMo Squares

Our Lady of Grace R.C. Church
Avenue W and East Fourth Street, Brooklyn, NY 11223

Sundays 7:30–10:00 pm

Alternating MS & PL

Sept. 12: Don Coy

Oct. 10: Randy Longobucco

Nov. 21: Howard Richman

Dec. 12: Don Coy

Jan. 9: Nick Martellacci

Wednesday Workshops start Sept. 22

ABC Dances at Historic Richmondtown, Staten Island, fourth Sundays of the month

Kathy: 917-699-2093 alemodancer@yahoo.com Norma Cangiano: 718-852-0318

MIDDLETOWN RAMBLERS – Leonardo

PL

www.middletonramblers.org

Every Fri. All Year

Croydon Hall, 900 Leonardville Rd. 07737

Kenneth Douglas: 732-581-4361

Cell for dance night: 732-581-4361

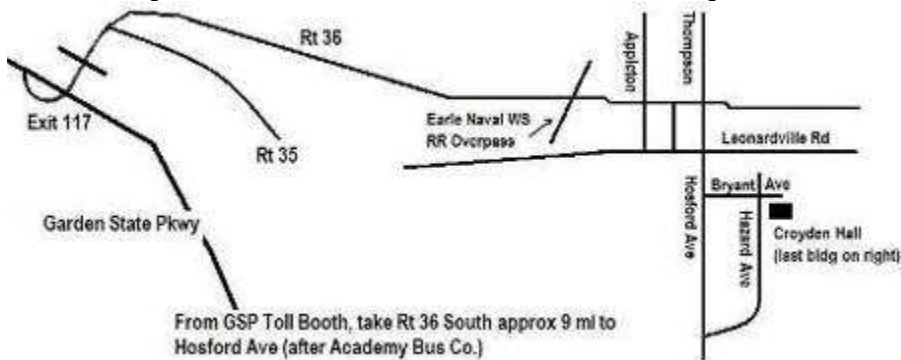

We Ramblers had a fairly busy summer. Thanks to the efforts of our high-energy president Al Peskoe, we were invited to the Monmouth Racetrack in Oceanport on July 25. Don Coy did an outstanding job as caller, and 70 square dancers from many NNJSDA clubs braved the heat to entertain onlookers. We relaxed in air-conditioned comfort between our three tips.

Our barn dances were huge successes. We had eight squares at our most recent dance, and more than half were newcomers. Wayne Applegate did a superb job, and there was sheer joy on their faces. We will be holding our final barn dance in a real barn at Thompson Park with Don Coy doing the honors.

The Middletown Ramblers Fall 2010 lineup has a lot of exciting callers. Please see our ad or website for details and directions. Hope to see you! Ramble on!

Ad on page 16

Jeanne Gannon (jmg52@comcast.net)

732-872-2377

Various Sun.

Borough Hall of Oradell
355 Kinderkamack Rd. 07649

Chariss Smith & Carl Luhrs: 201-489-2498

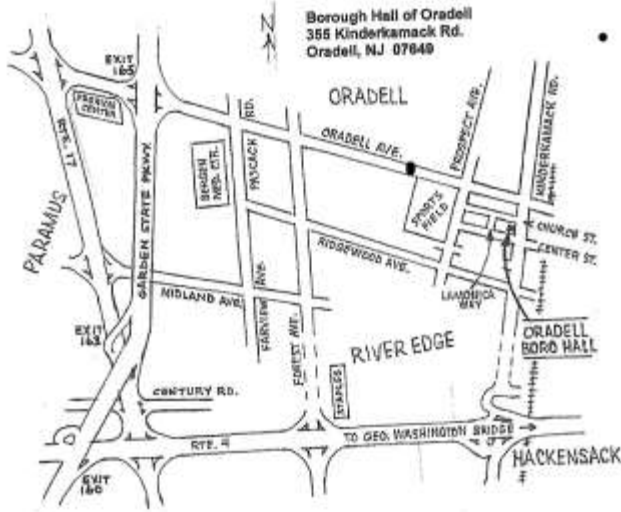

From April through August we enjoyed the calling talents of Ken Ritucci, Roy Leber, Betsy Gotta, Todd Felleg, Don Moger, Sandie Bryant, and Keith Stevens. Some of our “fun” tips included old calls no longer on the list (Ken), the names of the calls in reverse (Ocean the Pass Heads) (Betsy), and same-sex squares (Don).

On May 15, many of our members enjoyed the NNJSDA Special Plus Dance, where we supplied some delicious refreshments. The following evening, we welcomed a 10-couple raid from Mountain Squares. Thank you, Mountain Squares!

PLEASE NOTE: On October 10, international caller John Marshall will be calling both an afternoon and evening dance for us. Check our ad for specifics.

In May, Chariss Smith and Carl Luhrs toured Canada’s New Brunswick, Nova Scotia, Cape Breton, and Prince Edward Island. Even with the chilly weather they enjoyed the sights, ate lobster, rode ferries, and chatted with friendly Canadians. Sue and Rich Baumeister visited their daughter, as well as the Eastern Sierra Nevada Mountains, and Yosemite, Sequoia, and Kings Canyon National Parks, in central California. They traded 70-degree weather on the east coast for temperatures in the 50s, including snow! In July, Jan and Louis Thompson were given a very warm welcome when they attended the Gay National Convention in Chicago.

On a sad note, we extend our heartfelt condolences to Louis Thompson upon the passing of his mother. May you know no more sorrow.

Ad on page 17 Jan & Louis Thompson (LTPT1@yahoo.com) 732-577-9413

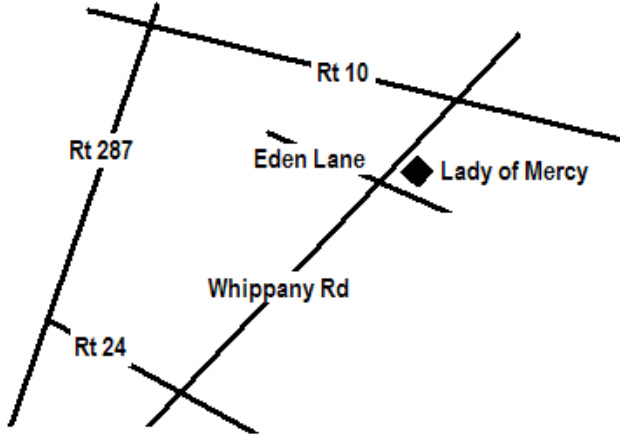

Ad on page 26

Paula & Roy Lawrence (*rlawr3@ptd.net*)

973-726-9463

“A Prairie Home Companion” at NJPAC

We attended the sixth annual NNJSDA/New Jersey Performing Arts Center collaboration on April 17 to see “A Prairie Home Companion,” one of our favorite radio shows, with Garrison Keillor. We have been his fans for many years and were very happy to put our love of square dancing together with Garrison’s unique show. We never know what to expect when listening on Saturday nights from 6 to 8 pm (when we’re home).

Both of us enjoyed the delicious barbecue in the company of other enthusiastic square dancers. We were once again warmly greeted by the NJPAC staff, including a personal welcome from Nicole Owens, Group Sales Manager.

It was fun to dance in the lobby while the other theatergoers are assembling, surprised to see real square dancing before the show and sometimes joining with us. Two new dancers from Circle Eights participated this year. Darlene and Walter Dorgan weren’t certain they were ready to go public, but we reassured them of our support. As it turned out, the house photographer was attracted to Darlene’s beautiful red square dance dress and she was featured in many pictures.

Garrison invited the audience to dance on stage to the bands playing during the first half of the show. We were hesitant at first, but decided to take the plunge when a band announced the jitterbug. We have been dancing jitterbug since before we were married – in fact, that’s how we met.

About nine years ago, we started square dancing and have met so many wonderful people. This is one of our favorite activities. In 2005 we attended the first NNJSDA/NJPAC partnership event, *Oklahoma!*, and have been to several subsequent shows. We look forward to many more years of dancing and attending the NJPAC.

Pat and Rich White (Circle Eights)

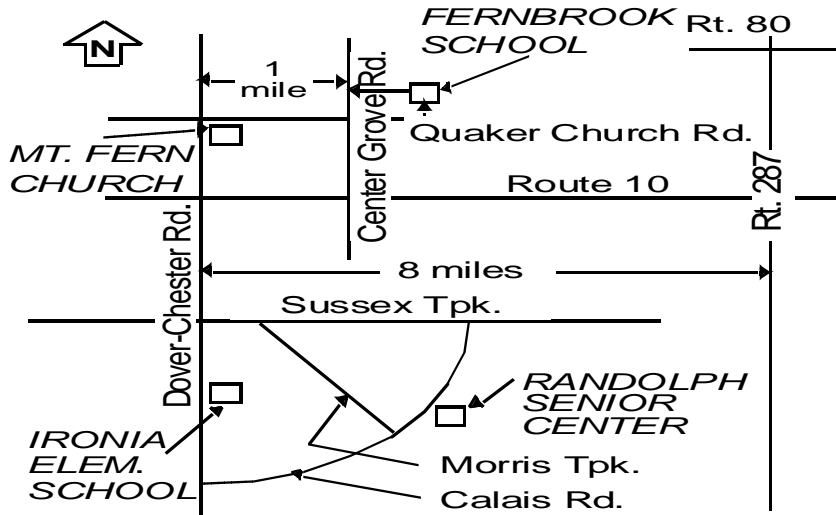

What a delicious potluck dinner we had at our final dance of the season on June 4th — scrumptious salads, marvelous main dishes, and delectable desserts. Joe Landi called a great dance and reminded us that the calls “are not optional.” The weather was hot, and so were the dancers!

During the last three consecutive dances, Reelers had visits from several local middle-school boys. They were so intrigued by the dancing that the night’s caller taught a learning tip especially for them. What fun we all had. Their enthusiasm was catching.

And speaking of lessons, Yolanda and John Garie and Joyce and Tom Gervasio completed Mainstream lessons in June. And what a lively group of angels we’ve had. It has been rumored that some of the guys were wrestling over an aqua pair of pettipants from a batch of donated clothes. At the next class one unnamed individual was seen wearing said pettipants tucked in his belt like a loincloth. Could this be the start of a new fashion trend?

Our dances start again in the fall. If you know people in the Randolph area interested in learning to square dance, invite them to join us for Mainstream classes on Tuesday nights at the Ionia Elementary School. Mike Patrick will be teaching.

Save April 10, 2011 for the Reelers’ 50th Anniversary Dinner Dance at the Zeris Inn. It will be an unforgettable event.

Ads on pages 6, 26, 47 Jeanne Gruntals (*inars23.jean21@verizon.net*) 973-543-7792

ROCKLANDROCKYTOPS – West Nyack, NY

www.sqrdance.org/RocklandRockytops

MS-PL tip 2 Fri. All Year

PL-A1 tip 1 Fri. Oct.–June

PL-A1 tip 3 Fri. July–Aug.

West Nyack Firehouse

42 Strawtown Rd. 10994

David & Miriam Gurowsky: 845-354-6351

Cell for dance night: 845-893-7687

Directions to West Nyack Firehouse

42 Strawtown Road, W. Nyack, NY 10994

From Palisades Interstate Parkway:

Take Exit 8-E (Route 59 East). Continue on Route 59 to first traffic light. Turn left onto Crosfield Avenue to the end. Turn right onto West Nyack Road and continue to traffic light. Turn left onto Strawtown Road. Firehouse is just past yellow blinker on the right.

From New York State Thruway:

Take Exit 13S to Palisades Interstate Parkway. Go ½ mile to Exit 8-E (Route 59 East). (**Follow instructions above for Palisades Interstate Parkway.**)

From Kinderkamack Road (NJ):

Kinderkamack Road becomes Route 304 in New York. Follow Route 304 North to Route 59 East. Turn onto Route 59 East. (**Follow instructions above for Palisades Interstate Parkway.**)

The seasons go by so fast. One day I'm writing while snow mounts up at the door. Tonight I write while the air conditioner is gamely trying to suck the humidity out of the air on another close-to-90-degree day. You will be reading this in September and hopefully will have found many opportunities to square dance over the summer. Thanks to Karen Mallozzi and the dancers who accompanied her, Rockytops met the NNJSDA 200-mile Raiders Challenge in our Spring 2010 season. Raid Chair Sherry Landis and Assistant Karen also scheduled post-season raids: in June to bid farewell to Spinning Wheels, and in July to Hix & Chix, to enjoy the calling and cueing of the Williamsons.

Half a dozen Rockytops members — Miriam and Dave Gurowsky, Karen and Jillene Mallozzi, Carole Van Nahl, and Patsy Lisak — attended the National Convention. They enjoyed the dancing, demos, educational panels, and exhibits. Dave enthused, "It is great to meet and dance with people and hear callers from all over the country and from around the world ... also to see old friends from northern NJ and the Hudson Valley."

Hopefully, Rockytops summer dances also were successful, including the free open house dancing for newcomers. Now the Fall 2010 season begins. See our ad in this issue for our exciting lineup of callers.

Ad on page 19 Joan Schierlitz (dancinggrandma@verizon.net) 845-353-2987

New Jersey Drivers — Advertise your love of Square Dancing

Square Dance License Plates

are available. Application forms are available at NNJSDA dances or call Rich Delgado at 609-844-1140.

RUTGERS PROMENADERS – Somerset

MS/RD

www.rutgerspromenaders.org

1 & 3 Sun. Sept.–June

**Franklin Township Senior Center
505 DeMott Ln. 08873**

Ken Robinson: 908-963-2447

Cell for dance night: 908-963-2447

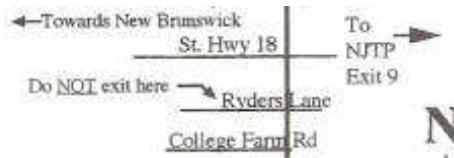

Do not use this map. The Promenaders have moved to:

**The Franklin Township Senior Center
505 DeMott Lane
Somerset, NJ 08873**

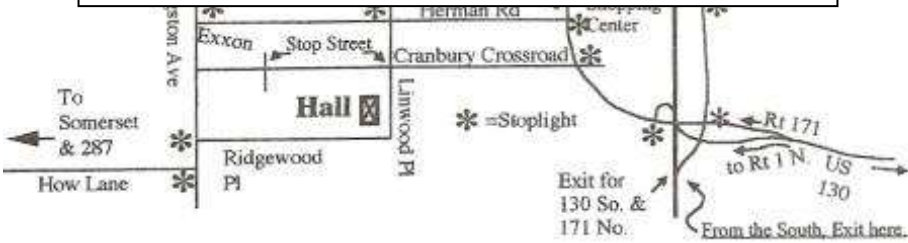

With respect for the Easter holiday (which, this year, turned out to be a regular dance day), it was decided to cancel in order to allow those who celebrate to spend time with their families.

We celebrated the “merry, merry month of May” with enthusiasm and “maypole” antics, and had a visiting caller, Larry Shipman, contribute during one of our “May Day” events, bringing a refreshing touch to the festivities.

We ended our dancing season on a very positive note thanks in no small part to raids by Cross Trail Squares and Circle Eights. Thank you for contributing to a successful end to a great dancing season!

Ad on page 11 Mary Ann Ryan-Erdek (erdekfamily@verizon.net) 732-271-9151

Hi Taws — A Challenge Club
 Various Tuesdays
 Paramus Senior Center — 93 Farview Avenue, Paramus, NJ 07652
 Challenge Dancing: C2 — 7 pm to 8 pm C1 — 8 pm to 10 pm
Information: Bernie & Sandy 201-447-0538 Fred 201-797-3421



HUNTERDON FLUTTERWHEELS

Echo Hill Park, 43 Lilac Drive, Stanton Station, NJ

Web Address: hunterdonflutterwheels.nnjsda.org

Contact # night of dance: 908-672-0372



<u>2010</u>	<u>Theme</u>	<u>Caller</u>
Sept. 17	Welcome Back – <i>Start Dancing</i>	Ed Kerns
Oct. 1	Black & White Night – <i>Putting on the Ritz</i>	D. Reardon
15	Share Your Heritage – <i>With Food</i>	Ed Kerns
Nov. 5	Thank the Veterans – <i>Red, White, & Blue</i>	Jim Emory
19	Let's Share w/Others – <i>Food for Food Bank</i>	Ed Kerns
Dec. 3	Show Tunes – <i>Come in Character if you want</i>	H. Richman
17	Harry's Ho Ho Holiday Dance	Ed Kerns
<u>2011</u>		
Jan. 7	Funky Slippers Night – <i>Buy or Make Them</i>	B. Gotta

Alternate Mainstream & Plus Level Tips

Soft-Soled Shoes Please!

1st & 3rd Fridays 8:00–10:15 pm



For Information:

Donna & Joe 908-526-7496

Ruth 908-369-6471

Peg & Fred 908-574-5095

Demo at Monmouth Park Racetrack

On July 25, a spectacular group of 70 square dancers performed at Monmouth Park racetrack in Oceanport, NJ. Don Coy did an excellent job calling for the dancers and onlookers.

Monmouth Park was a superb host. Our dancers received many freebies: admission, parking, food and drink, and program book. We were also provided with an air-conditioned area in which to relax between tips. Quite a few dancers proved to be good horse pickers, as I noticed great activity at the collection windows.

We thank the State of New Jersey, Monmouth Park, and Sofia Manglee, the track's event coordinator, for their hospitality. I, personally, want to thank each and every square dancer who danced in the 90+ degree weather and helped to make this event a huge success.

Al Peskoe, Middletown Ramblers

PATRON

Visit 13 Member Clubs and have the Patron form signed. No time limit.

Receive a dangle and free Mini-Festival ribbon!

Form: nnjsda.org/nnjsda_documents

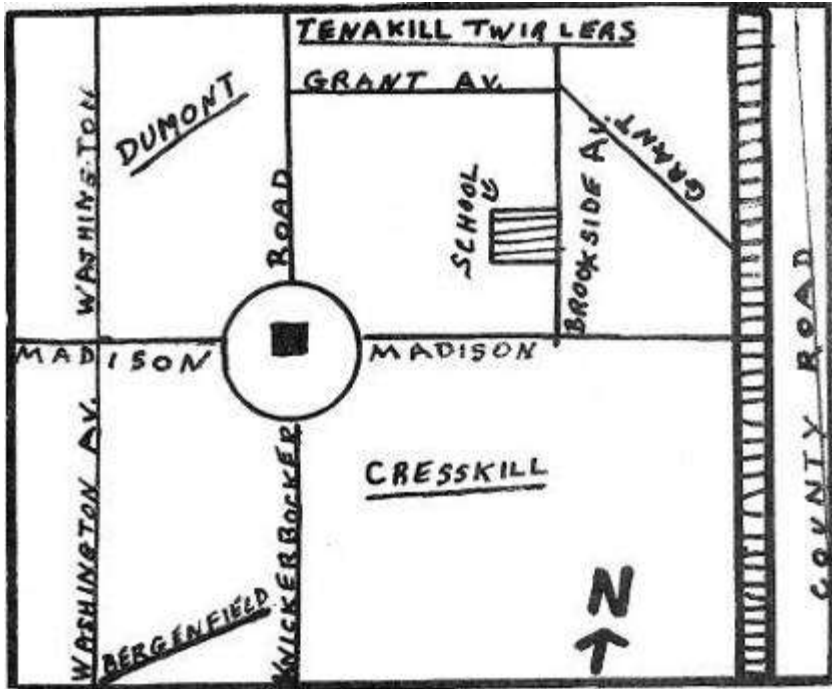

In October 2010, Tenakill Twirlers begins its 60th square dance season. We hope the new season finds our President Gloria in better health.

Roy Leber will start the ball rolling for us in October, followed by Howard Richman in November, Wayne Applegate in December, and Dan Koft in January. These callers know how to provide a fun evening for new and experienced dancers alike, so be sure to join us for a great time.

See you in a square!!

Ad on page 14 Joan Schierlitz (dancinggrandma@verizon.net) 845-353-2987

**60th NATIONAL
SQUARE DANCE CONVENTION
DETROIT, MICHIGAN
JUNE 22–25, 2011
GREAT LAKES – GREAT DANCING**
www.60nsdc.com

Western Wheelers

Plus Dancing 8:00–10:30 pm. “A” tip @ 10:30

Sept. 25 **Don Coy (1st dance)** #Oct. 2 **Dan & Kathy Koft+**
Oct. 23 **Dennis Reardon** Nov. 13 **Mark Franks**
Nov. 27 **Joe Landi** Dec. 11 **Jim Snyder**

December 31, 2010 New Year’s Eve

Join us for: Fun, Food, and Friendship at our NYE Gala*
with **Sandy Corey**

Co-sponsored by Circle 8s

Jan. 8 **Andy Woerner** Jan. 22 **Wayne Applegate**
Feb. 12 **Betsy & Roy Gotta+** Feb. 26 **Don Coy**
Mar. 12 **Howard & Donna Williamson+** Mar. 26 **Joe Landi**
Apr. 9 **Jim Snyder** May 14 **Glenn Matthew**

1st Saturday (2nd Saturday ceded to NNJSDA’s The Gathering)
+ Special Dances — Squares & Rounds — rounds 7:30-8:00 pm

* Please use sign-up sheet in this issue of *Grand Square*.

Come and Dance with Western Wheelers 2nd & 4th Saturdays

Info: Roger 201-384-0334 or Bob 201-664-4348

The Reformed Church of Oradell, 641 Church St., Oradell, NJ 07649

Visit us at: sqrdance.org/WesternWheelers

St. Aloysius Church (next to Grover Cleveland Birthplace)
NNJSDA Dance: Saturday, October 30, 2010

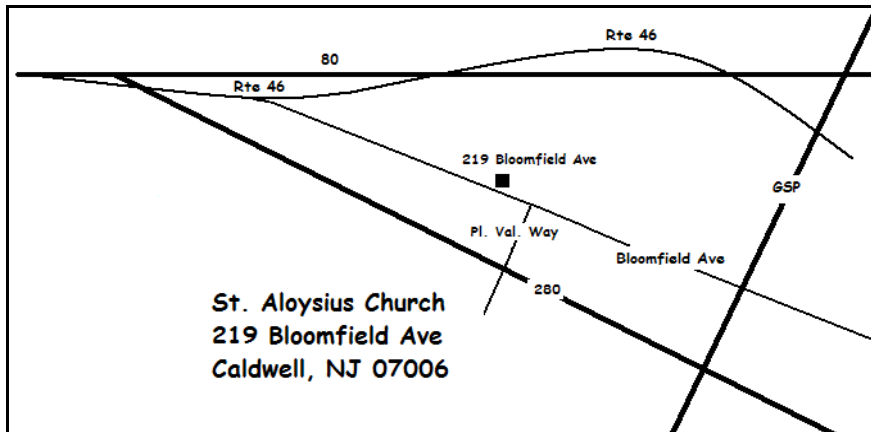

GSP: Exit 148 (Bloomfield Ave). Church is about 6 miles west on Bloomfield on right.

80 East: Exit 47B, Rte 46E; 2 miles, bear right onto Bloomfield Ave (Caldwell). Church is 3 miles on left.

Rte 280: Exit 7 (Pleasant Valley Way) to end (3 miles). Left onto Bloomfield Ave. Church is 1½ miles on right.

See NNJSDA.org for Google directions to all NNJSDA dances.

WESTERN WHEELERS – Oradell**PL/RD-A tip**www.sqrdance.org/Western.Wheelers**2 & 4 Sat. Sept.–April Reformed Church of Oradell, 641 Church St. 07649**

Roger & Maria Hoernlein: 201-384-0334 Bob & Hilda Bachmann: 201-664-4348

Cell for dance night: 201-390-5123

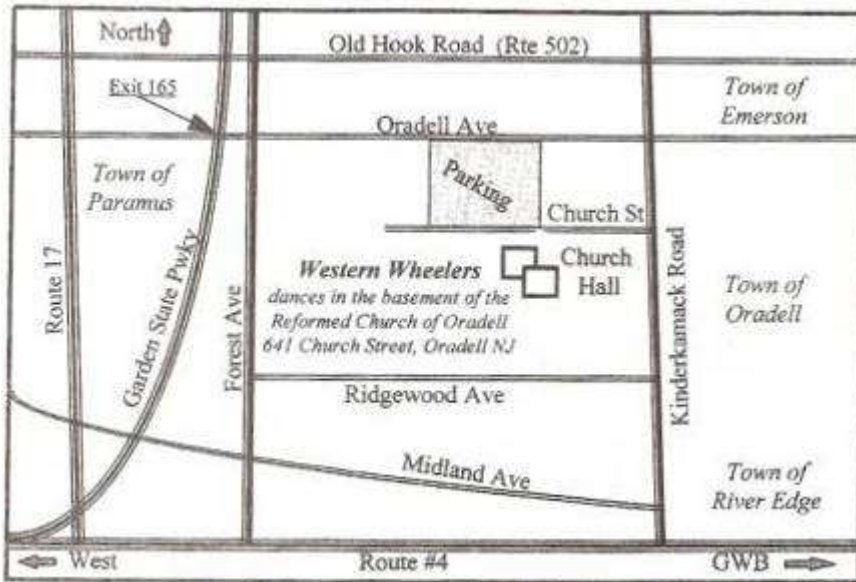

Western Wheelers held their annual meeting in May. The Co-Presidents, this year, are Roger Hoernlein and Bob Bachmann. Raids included Bee Sharps in March, Hix & Chix in June, and Lakeland Squares in July. Good job, Georgi and Richie, on completing the raid program for the year! On April 10, the Williamsons drew nine squares, including 14 members from Lakeland Squares. This time we had “lights by electric” not by candles. Our last dance of the season was called/cued by Don Coy and Karen Kushler. Hilda thanked everyone who so generously helped out all year with refreshments, and we thanked her for the great job that she did as coordinator of the kitchen staff refreshment schedule.

Ginny and Eric Mailman have moved to Delaware — we wish them much happiness. In April, the Huettemanns visited Holland. In May, Pat Korzelius went on an Alaskan cruise, and the Flanderas cruised to the Black and Baltic Seas. In June, Arlene Remington, Amy Golden, Barbara Berger, and Ginny and Eric Mailman attended the National Convention in Kentucky. On a sad note, we extend our sincere condolences on the passing of Rich Flandera’s father.

Round dancing will no longer be included in our regular program except for specials. Thank you, Peg Millar, for having served as our club cuer over the past few years. W/W is still a club that works towards extending camaraderie and friendship to all who attend. Come join us; you’ll like us, “the Friendly Club.” You’ll be glad you did!

Ad on page 56 Marilyn P. Bachman (margus258@aol.com) 201-261-3921

MAYWOOD'S SENIOR
RECREATION CENTER
for 3 new square dances

F.A.D. SQUARES

(please note the 1st and 3rd Sundays are still at St. Matthews in Paramus)

The three new dances will be

1st Thursday is a Mainstream dance,

3rd Thursday is a Plus dance

4th Sunday's is a FREE Barn dance

BRING YOUR FRIENDS

Map below shows location of new FAD dances in Maywood

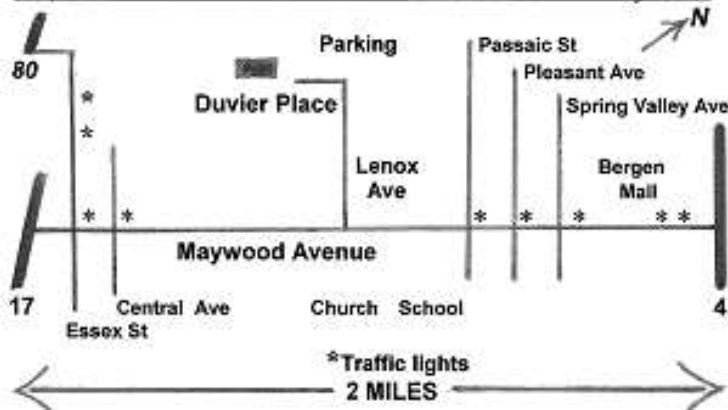

Route 80 East – Exit 63 Route 17N Rochelle Park Paramus. At Exit make a left at light make a right Essex St. After 2nd light make a left onto Maywood Ave, a left onto Lenox Ave and a left onto Duvier Place and a right into parking area.

Route 4 East and West – Exit Maywood Ave and Forest Ave. At light make a left onto Forest Ave becomes Maywood Ave. Make a right onto Lenox Ave and a left onto Duvier Ave and a right into parking area.

Route 17N – Exit Essex St Maywood Saddlebrook. At light go straight Maywood Ave. Make a left onto Lenox Ave and a left onto Duvier place make a right into parking area.

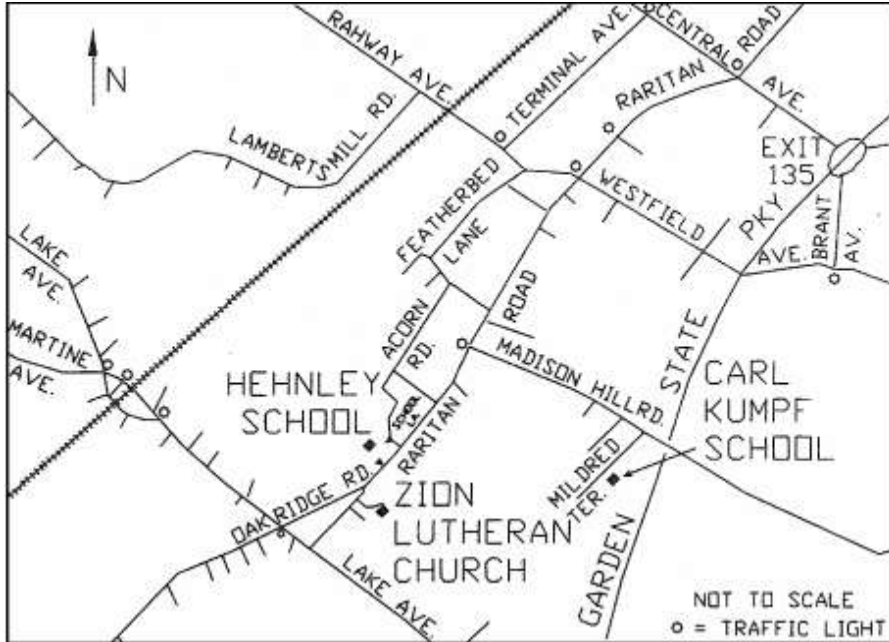

We are saddened by the loss of a valued friend and member of Y Squares. Norton Speck passed away in May. He was a faithful angel to our students for many years. We will miss Norton very much. Our hearts and prayers go out to Florence, his loving wife.

Madeleine and Joe Ostrowski are moving to Connecticut. They have served as 2nd vice presidents for a number of years. We wish them well in their move, and we hope to meet up with them on the dance floor somewhere.

Class coordinators Barbara and George Kuhne have graduated four students: James Bhasin, Pat Gorski, Sunny Kordower, and Marilyn Vice. They have been attending various dances. We wish them well.

Ad on page 29 Dianne & Don Madden (*olreggie@comcast.net*) 609-693-0247

Submit your ideas and comments to the NNJSDA Executive Board:

- Email the Co-Presidents (president@nnjsda.org).
- Click on the website Suggestion Box (www.NNJSDA.org).
- Place a note in the Suggestion Box on the Treasurer’s table at an NNJSDA dance.
- Place an NNJSDA Suggestion Box at your club Treasurer’s table and forward the notes to us.
- Discuss matters at your club meetings and have the President or Secretary inform us of the members’ consensus or ideas.

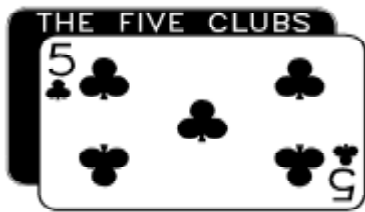

BEE SH AR PS
RUTGERS P ROMENADERS
Y S QUAR ES

NEW YEAR'S EVE DINNER DANCE

YMCA/CHISHOLM COMMUNITY CENTER
100 So. Springfield Ave. @ Shunpike Rd.
Springfield, NJ

FRIDAY, DEC. 31, 2010
7:30 PM Š 12:30 AM

DELICIOUS BUFFET DINNER

Tickets: \$30/per person
Ticket sellers listed below

**DANCE FORMAT: ALTERNATING MS
& Plus, with Rounds**

CALLER: JOE LANDI

**CUER: PEG & JOHN
KINCAID**

FOR TICKETS, CONTACT:

AMMONS	908-763-0050	vammons@gmail.com
ROBINSON	908-963-2447	kenrbnsn@rbnsn.com
SANDERSON	908-233-2414	paulmsanderson@aol.com



CROSS TRAIL SQUARES

PRESENTS THEIR

43rd ANNUAL DINNER DANCE

SUNDAY, MARCH 13, 2011

**At
The Brownstone House
351 W. Broadway
Paterson, NJ 973-595-8582**

12:30 PM TO 4:30 PM

Caller: Howard Williamson (Pa.)

Alternating Mainstream and Plus

FAMILY STYLE DINNER AND BEVERAGES

**\$35.00 per person
RSVP no later than Feb. 24, 2011**

**All Club's Members Are Welcome for
Great Dancing, Great Company, and Great Food!**

**For additional information please contact:
Alice DeLancey 973-618-9025 or Sal and Mary Alessi 973-256-1647**

Please Print

← _____

Name _____ **Club** _____

Address _____

City _____ **State** _____ **Zip+4** _____

_____ Tickets @ \$35 each — Total Amount Enclosed \$ _____

Please make checks payable to Cross Trail Squares and mail to:

**Sal Alessi
5 Villa Road
Little Falls, NJ 07424-2315**

CALENDAR OF ADVERTISED DANCES

Listing of dances, weekends, and workshops prepared from ads appearing **IN THIS ISSUE**. See ad for details. *Dances that are not club level are italicized.* All dances are in NJ unless specified. Abbreviations: A = Advanced; B = Basic; C = Challenge; MS = Mainstream; PL = Plus; RD = Rounds; TBA = To Be Announced; WS = Workshop

The / indicates equal time in the program. The – indicates one tip.

Date	Club	Caller/Cuer	Place	Program
SEPTEMBER				
1	Belles & Beaux	Tapper	Elmwood Park	MS – PL tip
2	F.A.D. Squares	Richman	Maywood	MS
5	F.A.D. Squares	Tapper	Paramus	MS – PL tip
8	Cross Trails Squares	Coy	Caldwell	MS/PL
10	Bee Sharps	Reardon/Bradt	Bound Brook	PL/RD – A tip
	Kittatinny Rangers	Applegate	Andover	MS/PL
	Middletown Ramblers	Landi	Leonardo	PL
	RocklandRockytops	Richman	W. Nyack, NY	ABCMS
12	NNJSDA Dance	Hass	Elmwood Park	MS
	AleMo Squares	Coy	Brooklyn, NY	MS/PL – A tip
	Motiv8ors	Ritucci	Oradell	A2/C1
14	Lakeland Squares	Hardys	Montville	MS/PL
	<i>Y Squares</i>	<i>Koft</i>	<i>Clark</i>	<i>Open House</i>
15	Belles & Beaux	Kapnick	Elmwood Park	MS – PL tip
	Mountain Squares	Landi	Whippany	A2
16	F.A.D. Squares	G. Hardy	Maywood	PL
17	Hunterdon Flutter	Kerns	Stanton Station	MS/PL
	Middletown Ramblers	Franks	Leonardo	PL
	Reelers	Wadel/Pickett	Randolph	<i>Open House</i>
19	F.A.D. Squares	Applegate	Paramus	MS – PL tip
	Motiv8ors	Hodge	Oradell	A2/C1
	Rutgers Promenaders	Gottas and/or Kofts	Somerset	MS/RD
21	Lakeland Squares	Richman	Montville	MS/PL
22	Cross Trails Squares	Richman	Caldwell	MS/PL
23	Y Squares	Koft/Pickett	Clark	MS/PL/RD
24	Bee Sharps	Richman/Pickett	Bound Brook	PL/RD – A tip
	Circle Eights	Coy	Haworth	MS – PL tip
	Kittatinny Rangers	Koft	Andover	MS/PL
	Middletown Ramblers	Matthew	Middletown	PL
25	Western Wheelers	Coy	Oradell	PL – A tip
26	<i>AleMo Squares</i>	<i>Kanter</i>	<i>Staten Is., NY</i>	<i>ABC</i>
	<i>F.A.D. Squares</i>	<i>Applegate</i>	<i>Maywood</i>	<i>Barn Dance</i>
	Motiv8ors	Ritucci	Oradell	A2/C1
28	Lakeland Squares	Ingis	Montville	MS/PL
OCTOBER				
1	Hunterdon Flutter	Reardon	Stanton Station	MS/PL
	<i>Middletown Ramblers</i>	<i>Coy</i>	<i>Lincroft</i>	<i>Open House</i>
	Reelers	Matthew/Pickett	Randolph	PL/RD
	RocklandRockytops	Franks	W. Nyack, NY	PL – A tip
2	Western Wheelers	Koft/Koft	Oradell	PL/RD – A tip
3	F.A.D. Squares	Leber	Paramus	MS – PL tip
	Rutgers Promenaders	Gottas and/or Kofts	Somerset	MS/RD
5	Lakeland Squares	Snyder	Montville	MS/PL
6	Belles & Beaux	Martellacci	Elmwood Park	MS – PL tip
	Mountain Squares	Landi	Whippany	A2
7	F.A.D. Squares	Koft	Maywood	MS

OCTOBER continued

8	Bee Sharps	Murphy/Godfrey	Bound Brook	PL/RD – A tip
	Kittatinny Rangers	Wadel	Andover	MS/PL
	Middletown Ramblers	Koft	Leonardo	PL
	RocklandRockytops	Snyder	W. Nyack, NY	MS – PL tip
9	NNJSDA Gathering	Marshall	New Brunswick	MS/PL/RD
10	AleMo Squares	Longobucco	Brooklyn, NY	MS/PL – A tip
	Motiv8ors	Marshall	Oradell	A2/C1
12	Lakeland Squares	Leber	Montville	MS/PL
13	Cross Trails Squares	Koft	Caldwell	MS/PL
14	Y Squares	Ritucci/Pickett	Clark	MS/PL/RD
15	Hunterdon Flutter	Kerns	Stanton Station	MS/PL
	Middletown Ramblers	Franks	Leonardo	PL
	Reelers	Snyder/Pickett	Randolph	PL/RD
	Tenakill Twirlers	Leber	Cresskill	MS – PL tip
17	F.A.D. Squares	Coy	Paramus	MS – PL tip
	Rutgers Promenaders	Gottas and/or Kofts	Somerset	MS/RD
19	Lakeland Squares	Page	Montville	MS/PL
20	Belles & Beaux	Richman	Elmwood Park	MS – PL tip
21	F.A.D. Squares	Martellacci	Maywood	PL
22	Bee Sharps	Ritucci/Bradt	Bound Brook	PL/RD – A tip
	Circle Eights	Koft	Haworth	MS – PL tip
	Kittatinny Rangers	Applegate	Andover	MS/PL
	Middletown Ramblers	Adams	Leonardo	PL
23	Western Wheelers	Reardon	Oradell	PL – A tip
24	<i>F.A.D. Squares</i>	<i>Richman</i>	<i>Maywood</i>	<i>Barn Dance</i>
	Motiv8ors	Hodge	Oradell	A2/C1
26	Lakeland Squares	Richman	Montville	MS/PL
27	Cross Trails Squares	Leber	Caldwell	MS/PL
28	Y Squares	Koft/Pickett	Clark	MS/PL/RD
29	Middletown Ramblers	Richman	Leonardo	PL
30	NNJSDA Dance	Adams/Styer	Caldwell	MS/PL/RD

NOVEMBER

3	Belles & Beaux	Applegate	Elmwood Park	MS – PL tip
	Mountain Squares	Landi	Whippany	A2
4	F.A.D. Squares	Tapper	Maywood	MS
5	Hunterdon Flutter	Emory	Stanton Station	MS/PL
	Middletown Ramblers	Reardon	Leonardo	PL
	Reelers	Landi/Pickett	TBA	PL/RD
	RocklandRockytops	Martellacci	W. Nyack, NY	PL – A tip
7	F.A.D. Squares	Foote	Paramus	MS – PL tip
	Motiv8ors	Ritucci	Oradell	A2/C1
	Rutgers Promenaders	Gottas and/or Kofts	Somerset	MS/RD
9	Lakeland Squares	Foote	Montville	MS/PL
10	Cross Trails Squares	Foote	Caldwell	MS/PL
11	Y Squares	Gotta/Gotta	Clark	MS/PL/RD
12	Bee Sharps	Gotta/Gotta	Bound Brook	PL/RD – A tip
	Kittatinny Rangers	Reardon	Andover	MS/PL
	Middletown Ramblers	Kauffman	Leonardo	PL
	RocklandRockytops	Foote	W. Nyack, NY	MS – PL tip
13	Western Wheelers	Franks	Oradell	PL – A tip
14	36th NNJSDA Mini-Festival	Story, Matthew, Ritucci/Gotta	Bridgewater	MS/PL/A/C/RD
16	Lakeland Squares	McFarland	Montville	MS/PL
17	Belles & Beaux	Foote	Elmwood Park	MS – PL tip
18	F.A.D. Squares	Leber	Maywood	PL

NOVEMBER continued

19	Hunterdon Flutter	Kerns	Stanton Station	MS/PL
	Middletown Ramblers	Foote	Leonardo	PL
	Reelers	Reardon/Kushla	Randolph	PL/RD
	Tenakill Twirlers	Richman	Cresskill	MS – PL tip
21	AleMo Squares	Richman	Brooklyn, NY	MS/PL – A tip
	F.A.D. Squares	Applegate	Paramus	MS – PL tip
	Rutgers Promenaders	Gottas and/or Kofts	Somerset	MS/RD
23	Lakeland Squares	Ingis	Montville	MS/PL
26	Circle Eights	Richman	Haworth	MS – PL tip
27	Western Wheelers	Landi	Oradell	PL – A tip
28	<i>F.A.D. Squares</i>	<i>Ingis</i>	<i>Maywood</i>	<i>Barn Dance</i>
	Motiv8ors	Fellegly	Oradell	A2/C1
30	<i>Lakeland Squares</i>	<i>Richman</i>	<i>Montville</i>	<i>Barn Dance</i>

DECEMBER

1	Belles & Beaux	Wadel	Elmwood Park	MS – PL tip
	Mountain Squares	Landi	Whippany	A2
2	F.A.D. Squares	Leber	Maywood	MS
3	Hunterdon Flutter	Richman	Stanton Station	MS/PL
	Middletown Ramblers	Koft	Leonardo	PL
	Reelers	Anfinsen/Pickett	Randolph	PL/RD
	RocklandRockytops	Ritucci	W. Nyack, NY	PL – A tip
5	F.A.D. Squares	Gotta	Paramus	MS – PL tip
	GSSD Campers	Williamson/Williamson	Paterson	PL/RD
	Rutgers Promenaders	Gottas and/or Kofts	Somerset	MS/RD
7	Lakeland Squares	Reardon	Montville	MS/PL
8	Cross Trails Squares	Landi	Caldwell	MS/PL
9	Y Squares	Hardys/Pickett	Clark	MS/PL/RD
10	Bee Sharps	Snyder/McGees	Bound Brook	PL/RD – A tip
	Kittatinny Rangers	Coy	Andover	MS/PL
	Middletown Ramblers	Hardys	Leonardo	PL/RD
	RocklandRockytops	Leber	W. Nyack, NY	MS – PL tip
11	Western Wheelers	Snyder	Oradell	PL – A tip
12	AleMo Squares	Coy	Brooklyn, NY	MS/PL – A tip
14	<i>Lakeland Squares</i>	<i>Wadel</i>	<i>Montville</i>	<i>Student Dance</i>
15	Belles & Beaux	Richman	Elmwood Park	MS – PL tip
16	F.A.D. Squares	Coy	Maywood	PL
17	Hunterdon Flutter	Kerns	Stanton Station	MS/PL
	Middletown Ramblers	Franks	Leonardo	PL
	Reelers	Matthew/Pickett	Randolph	PL/RD
	Tenakill Twirlers	Applegate	Cresskill	MS – PL tip
19	F.A.D. Squares	Martellacci	Paramus	MS – PL tip
	Motiv8ors	Fellegly	Oradell	A2/C1
	Rutgers Promenaders	Gottas and/or Kofts	Somerset	MS/RD
21	Lakeland Squares	Richman	Montville	MS/PL
31	A2 Dance	Gotta, Ritucci/Gotta	Colonie, NY	A2/RD
	Circle 8s/Western Wh.	Corey	Oradell	MS/PL
	Five Clubs	Landi/Kincaids	Springfield	MS/PL/RD
	Middletown Ramblers	Matthew	Leonardo	PL

JANUARY 2011

2	F.A.D. Squares	Richman	Paramus	MS – PL tip
	Rutgers Promenaders	Gottas and/or Kofts	Somerset	MS/RD
4	Lakeland Squares	Richman	Montville	MS/PL
5	Belles & Beaux	Applegate	Elmwood Park	MS – PL tip
6	F.A.D. Squares	Richman	Maywood	MS
7	Hunterdon Flutter	Gotta	Stanton Station	MS/PL
	Reelers	Leber/Pickett	Randolph	PL/RD
	RocklandRockytops	Fellegly	W. Nyack, NY	PL – A tip

JANUARY continued

8	Western Wheelers	Woerner	Oradell	PL – A tip
9	NNJSDA Mid-Term Dance	Class Teachers	Caldwell (tent.)	Student Dance
	AleMo Squares	Martellacci	Brooklyn, NY	MS/PL – A tip
11	Lakeland Squares	Koft	Montville	MS/PL
12	Cross Trails Squares	Martellacci	Caldwell	MS/PL
13	Y Squares	Koft/Pickett	Clark	MS/PL/RD
14	Bee Sharps	Koft/Pickett	Bound Brook	PL/RD – A tip
	Kittatinny Rangers	Patrick	Andover	MS/PL
	RocklandRockytops	Gotta	W. Nyack, NY	MS – PL tip
16	F.A.D. Squares	Gotta	Paramus	MS – PL tip
	Rutgers Promenaders	Gottas and/or Kofts	Somerset	MS/RD
18	Lakeland Squares	Leber	Montville	MS/PL
19	Belles & Beaux	Tapper	Elmwood Park	MS – PL tip
20	F.A.D. Squares	Koft	Maywood	PL
21	Hunterdon Flutter	Kerns	Stanton Station	MS/PL
	Reelers	Snyder/Kushla	TBA	PL/RD
	Tenakill Twirlers	Koft	Cresskill	MS – PL tip
22	Western Wheelers	Applegate	Oradell	PL – A tip
23	<i>F.A.D. Squares</i>	<i>Snyder</i>	<i>Maywood</i>	<i>Barn Dance</i>
25	Lakeland Squares	Patrick	Montville	MS/PL
26	Cross Trails Squares	Patrick	Caldwell	MS/PL
27	Y Squares	Applegate/Pickett	Clark	MS/PL/RD
28	Bee Sharps	Gotta/Gotta	Bound Brook	MS/PL/RD
	Circle Eights	Leber	Haworth	MS – PL tip
	Kittatinny Rangers	Applegate	Andover	MS/PL
29	NNJSDA Dance	Franks/Wagenhoffer	Rockaway (tent.)	MS/PL/RD

FEBRUARY

1	Lakeland Squares	Richman	Montville	MS/PL
2	Belles & Beaux	Ingis	Elmwood Park	MS – PL tip
3	F.A.D. Squares	Patrick	Maywood	MS
4	Hunterdon Flutter	Tapper/Thielke	Stanton Station	MS/PL
	Reelers	Reardon/Pickett	TBA	PL/RD
	RocklandRockytops	Richman	W. Nyack, NY	PL – A tip
6	F.A.D. Squares	Leber	Paramus	MS – PL tip
	Rutgers Promenaders	Gottas and/or Kofts	Somerset	MS/RD
8	<i>Lakeland Squares</i>	<i>Wadel</i>	<i>Montville</i>	<i>Student Dance</i>
9	Cross Trails Squares	Gotta	Caldwell	MS/PL
11	Bee Sharps	Matthew/Bradt	Bound Brook	PL/A2/RD
	Kittatinny Rangers	Tapper	Andover	MS/PL
	RocklandRockytops	<i>Wadel</i>	<i>W. Nyack, NY</i>	<i>Student Dance</i>
12	Western Wheelers	Gotta/Gotta	Oradell	PL/RD – A tip
15	Lakeland Squares	Ingis	Montville	MS/PL
16	Belles & Beaux	Koft	Elmwood Park	MS – PL tip
17	F.A.D Squares.	Richman	Maywood	PL
18	Hunterdon Flutter	Kerns	Stanton Station	MS/PL
	Reelers	Franks/Pickett	Randolph	PL/RD
	Tenakill Twirlers	Richman	Cresskill	MS – PL tip
20	F.A.D. Squares	Applegate	Maywood	MS – PL tip
	Rutgers Promenaders	Gottas and/or Kofts	Somerset	MS/RD
22	Lakeland Squares	Tapper	Montville	MS/PL
25	Bee Sharps	Reardon/Pickett	Bound Brook	MS/PL/RD – A
	Circle Eights	Martellacci	Haworth	MS – PL tip
	Kittatinny Rangers	Koft	Andover	MS/PL
26	Western Wheelers	Coy	Oradell	PL – A tip
27	<i>CCNJ</i>	<i>Class Teachers</i>	<i>Elmwood Park</i>	<i>Student Dance</i>
	<i>F.A.D. Squares</i>	<i>Coy</i>	<i>Maywood</i>	<i>Barn Dance</i>

Workshops at Every Dance

Circle Eights	first ¼ hour of dance	Haworth	PL
Cross Trail Squares	½ hour before dance	Caldwell	PL
Lakeland Squares	second ¼ hour of dance	Montville	PL
Mountain Squares	every dance as needed	Whippany	A2
RocklandRockytops	¼ hour before dance	West Nyack, NY	DBD
Western Wheelers	½ hour before dance	Oradell	RD
Y Squares	one tip each dance	Clark	PL

Conventions, Festivals, Specials, and Weekends

September

11–13 A2 Weekend at Bates Boonville, NY A2 – C1 tips
Rocky's

12 **NNJSDA Special** Hass Elmwood Park MS

October

15–17 Tumbling Leaves Bates, Harrison, Bennington, VT MS/PL/A1/A2/
Moger, Dougherty, Marshall, Ritucci/Collipi, Bradt C1/C2/RD
30 **NNJSDA** Adams/Styer Caldwell MS/PL/RD

November

14 **36th NNJSDA** Story, Matthew, Bridgewater MS/PL/A/C/RD
Mini-Festival Ritucci/Gotta

December

5 Campers Dinner Williamson/Williamson Paterson PL/RD – A tip
Dance

31 Five Clubs Landi/Kincaid Springfield MS/PL/RD
Circle Eights & Corey Oradell MS/PL
Western Wheelers

A2 Dinner Dance Ritucci, Gotta/Gotta Colonie, NY A2 – C1 tips

January

9 **NNJSDA Mid-Term** Class Teachers Caldwell (tent.) Student Dance

29 **NNJSDA Dance** Franks/Wagenhoffer Rockaway (tent.) MS/PL/RD

February

27 *Mid-Winter Mania* CCNJ Callers/Teachers Elmwood Park Student Dance

March

13 Cross Trail Squares Williamson Paterson MS/PL
43rd Anniversary Dinner Dance

April

10 Reelers Miller/Pickett Mountain Lakes PL/RD
50th Anniversary Dinner Dance

May

21 **NNJSDA Special** Shipman/TBA Caldwell (tent.) PL/STAR/RD

June

22–25 **60th National Square Dance Convention** Detroit, Michigan

Advanced and Challenge Dances

A2, C1, and C2, Clark, NJ Area; Mondays

Daryl Murphy 917-770-6754 kenanddaryl@msn.com

Rich Delgado 609-844-1140 richd1squarerounddancer@msn.com

ADVERTISERS' INDEX

*Please tell our advertisers that you saw their ad in **Grand Square**.*

A1 Class	20	Five Clubs NYE	60	NNJSDA Dances ...	3,4,11,43
A2 Weekend	67	GS Campers Dinner Dance .	25	Reelers	26
A2 New Year's Eve	42	The Gathering	34,35	Mainstream Class	6
Adv./Challenge Dances ...	66	Hi Taws	53	50th Anniversary	47
AleMo Squares	48	Hunterdon Flutterwheels	54	RocklandRockytops	19
All-Position Plus Class	36	Kittatinny Rangers	46	Rutgers Promenaders	11
Bee Sharps	38	Lakeland Squares	31	Square D Fashions	5
Belles & Beaux	43	Middletown Ramblers	16	Tenakill Twirlers	14
Circle Eights	23	Mid-Winter Mania	44	Tumbling Leaves	7
New Year's Eve MS/PL	21	Mini-Festival	40,41	Western Wheelers	56
Cross Trail Squares	9,61	Motiv8ors	17	New Year's Eve MS/PL ...	21
F.A.D. Squares	37	Mountain Squares	26	Y Squares	29
Maywood Location	58	M R Square Dance Club	24		

Red Bates's

A2 Weekend

At **ROCKY'S** in Boonville, New York

September 10-12

Casual Dress * C1 Sessions * Potluck Dinner

Dance Sessions: 7 pm Friday to 11 am Sunday

\$60/couple

Dance Information: Red Bates: 941-223-0987,
redbates@juno.com

Camp Registration/Information: Doris Lyon: 315-942-2250/5142

Headwaters Motor Lodge: 315-942-4493 (Discount available)

The Edge Hotel (Lyons Falls) 866-348-4211

ARTICLES IN THIS ISSUE

Belles & Beaux Demo	13	Murder in Glen Rock	36
Bio: Lise Greene & Mark Bippes	12	NJPAC	50
Calendar of NNJSDA Events	4	National Convention News	
CCNJ News	24	Competition at Louisville	14
Classes	8,10	NNJSDA at Louisville	10,29
Club News Begins	20	Denver, 2011	55
Dance Calendar	62-66	One Square Is Fair	17,36
Demo at Monmouth Park Racetrack	54	Patron Awards	27
Event Maps	15,27,39,56	Presidents' Letter	3
<i>Grand Square</i> Benefit Dance	6	Raids Completed	17
Host Clubs Thank You	23	What Moves Us?	13
Letter from the Editor	10	Youth Square Dancing	18
Letter to the Editor	5		

NNJSDA MEMBER CLUBS

See club articles (alphabetically A–Z) and ads for further information. Advertisers' Index appears on the inside back cover. Clubs desiring to change dance night or location **MUST** contact the Recording Secretary (listed on page 2) for clearance.

MAINSTREAM

Sunday	Weeks of the Month
F.A.D. Squares <i>c.c.oconnor@att.net</i>	1, 3 All Year
Rutgers Promenaders <i>kenrbnsn@rutgerspromenaders.org</i>	1, 3 Sept.–June
Wednesday	
Belles & Beaux <i>squaredancing123@gmail.com</i>	1, 3 All Year
Friday	
Circle Eights <i>NVStewart@verizon.net</i>	4 Sept.–June
RocklandRockytops <i>jgurumd@verizon.net</i>	2 All Year
Tenakill Twirlers	3 Oct.–May

ALTERNATE MAINSTREAM/PLUS

Sunday	Weeks of the Month
AleMo Squares <i>alemodancer@yahoo.com</i>	Various Sept.–June
Tuesday	
Lakeland Squares <i>lakelandsquares@hotmail.com</i>	1, 2, 3, 4 Sept.–July
Wednesday	
Cross Trail Squares <i>kapnickrr@juno.com</i>	2, 4 Sept.–June
Thursday	
Y Squares <i>paulmsanderson@aol.com</i>	2, 4 Sept.–May
Friday	
Bee Sharps <i>beesharps@squaredancing.com</i>	2, 4 Sept.–May
Hunterdon Flutterwheels <i>kwiatak@att.net</i>	1, 3 Sept.–June
Kittatinny Rangers <i>tyburski@embarqmail.com</i>	2, 4 Sept.–May
Saturday	
Five Clubs <i>vammons@gmail.com</i>	1, 3 June–Aug.

PLUS

Thursday	
Hix & Chix	Various June–Aug.
Friday	
Middletown Ramblers <i>lorddouglasII@hotmail.com</i>	Every Week All Year
Reelers <i>avyril.brady1@verizon.net</i>	1, 3 Sept.–June
RocklandRockytops <i>jgurumd@verizon.net</i>	1 Oct.–June 3 July–Aug.
Saturday	
Western Wheelers <i>rhoernlein@optonline.net</i>	2, 4 Sept.–April

ADVANCED & CHALLENGE

Sunday	
Motiv8ors (A2, C1) <i>charartist@aol.com</i>	Various All Year
Tuesday	
Hi Taws (C1, C2) <i>bbeck123@aol.com</i>	Various All Year
Wednesday	
Mountain Squares (A2) <i>rlawr3@ptd.net</i>	1, 3 Sept.–Dec. Mar.–June

DANCES CANCELED — See Club Ads

September	November	December	December
4 RocklandRockytops	2 Lakeland Squares	22 Cross Trails	26 F.A.D. Squares
7 Lakeland Squares	24 Cross Trails	23 Y Squares	28 Lakeland Squares
October			
9 Western Wheelers	25 All Clubs	24 All Clubs	
	26 Bee Sharps	25 All Clubs	
	Kittatinny Rangers		

The editor of *Grand Square* reserves the right

to edit, correct, or otherwise modify articles or ad copy submitted for publication.

Signed articles are the opinions of the authors and not necessarily those of the NNJSDA.

Check www.NNJSDA.org for changes made after *Grand Square* is distributed.