

Grand Square

OFFICIAL

PUBLICATION

NORTHERN NEW JERSEY SQUARE DANCERS ASSOCIATION
Vol. 40 - No. 2 Winter/Spring Issue Jan.-May, 1998



Grand Square

OFFICIAL PUBLICATION

EDITORS EMERITUS :

Doc & Peg Tirrell

EDITORS:

Charlie & Kathy Porter

99 Stanley Ave, Staten Island, NY 10301

Home: 718-448-9761

Kathy Office: 201-938-5517

Fax: 201-938-5444

e-mail: kathy_porter@trs.dowjones.com

FOR OVERNIGHT DELIVERIES ONLY

Kathy Porter c/o Dow Jones Markets

Harborside Fin. Ctr., 600 Plaza Two

Jersey City, NJ 07311

Associate Editors:

Greg & Karen Kushla

973-593-8440

Billing:

Leo & Lois Bichler

718-356-2208

Northern Area Reporter:

Henry Shiman

201-866-0723

Southern Area Reporter:

Frank & Helen Cavanaugh

609-859-1937

Western Area Reporter:

Donna Poyer

908-852-9285

Western Area Distribution:

Bill & Erma Donaldson

201-627-7975

NNJSDA OFFICERS 1997-1998

Pres: Sal & Mary Alessi
5 Villa Rd, Little Falls, NJ 07424
973-256-1647

1st VPs: Jim & Barbara Thoma
8 Wilson Ave, Staten Island, NY
10308 718-948-3056

2nd VPs: Richard & Linda O'Keefe
275 Northfield Ave, #13, W. Orange,
NJ 07052 973-243-0192

3rd VPs: Bill & Elsie Beebe
405 William St, Boonton, NJ
07005 973-335-0127

Rec Sec: David Wolin & Susan Jurgensen
181 Bonhomme St, Hackensack,
NJ 07601 201-525-1925

Corr Sec: Bernie & Sandy Beck
657 Prospect St, Glen Rock, NJ
07452 201-447-0538

Treas: Bob & Mary King
8 Mohave Path, Branchburg, NJ
08876 908-218-9007

PUBLISHED 3 TIMES A DANCE SEASON

SEPTEMBER, JANUARY, & MAY

Circulation: over 1,700

Deadlines	Due Out:	Theme:
Mar. 17, '98	May 3, '98	Grads/Summer
July 17, '98	Aug. 29, '98	Fall
Nov. 17, '98	Jan. 17, '99	Winter/Spring

ADVERTISING RATES

Actual Size	NNJSDA	Non-
Necessary for	Member	Member
Camera-Ready Ads	Clubs	Advertiser
Full: 6"W x 10"H	\$52.00	\$57.00
3/4: 6"W x 7-1/2"H	39.00	49.00
1/2: 6"W x 5"H	26.00	31.00
1/4: 6"W x 2-1/2"H	13.00	18.00
1/8: 6"W x 1-1/4"H	6.50	11.00

Any ad submitted with dimensions other than listed above is not camera-ready.

Printer reduces copy by 33% when printing.
Use largest type to fit size.

The following extra charges may apply:

Creating ad from rough copy	\$20.00
Corrections, sizing, etc.	5.00
Bills unpaid after 30 days	2.00

Make all checks payable to Grand Square.

Subscriptions: \$5.00 for 3 issues.

Send all ad copy, checks,
articles, and subscriptions to Editors.

PRODUCTION STAFF

Sal & Mary Alessi, Leo & Lois Bichler
Greg & Karen Kushla

Asst Treas: Roger & Maria Hoernlein
36 Willow St, Bergenfield, NJ 07621
201-384-0334

Past Pres: Jim & Joyce Kelly
RD #2, Box 224A, Basking Ridge, NJ
07920 908-658-4271

COMMITTEE CHAIRMEN 1997-1998

CCNJ Liaisons:
Ron Kapnick & Ruth Edison
973-857-8879

Insurance :
Fred & Kathryn Hill 732-849-1606

NNJRDLC Liaisons:
Ralph & Marilyn Neibart 973-762-8481

SDCNJ Liaisons:
Norman & Audrey Bolin 973-729-9327

NJ State Outfit:
Rusty & Richard Ball 973-838-0312

From the computer of... **SAL & MARY ALESSI, NNJSDA PRESIDENTS**

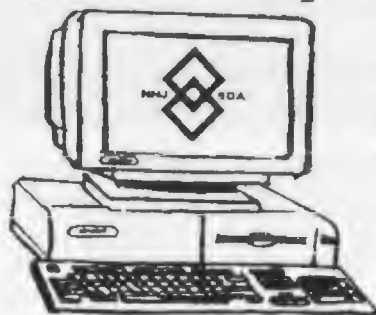

The 23rd NNJSDA Mini-Festival held on November 9, 1997 in Bridgewater, NJ, as reported by our Registrars, was a social and financial success. We had approximately 535 dancers attending. This was a slight increase from last year's 507 dancers. Of the 30 NNJSDA member clubs, 25 made "One Square is Fair." We want to thank the delegates for their efforts and all the dancers for their attendance. A special thank you to the Executive Committee for their hard work, especially our Registrars, Norman & Audrey Bolin, and Past Presidents, Jim & Joyce Kelly.

It was brought to our attention that round dancers believe the cuers did something to alienate the NNJSDA and this was why we did not have round dancing at the Summer Dances. We want to clear up this misconception. The Summer Dance Program was conceived for the benefit of new graduate dancers. A few things were tried like rotating round dancing and line dancing. Due to the decline in the number of graduates, we tried an alternating Mainstream/Plus Program on Saturdays, hoping to encourage supporters of the new dancers to attend. To include round dancing with this program would allow too little time for the new graduates to square dance. The Saturday dances were financial successes. The Wednesday dances were financial disasters. We hope this dispels the misconception.

We hope all of you had Happy Holidays.

Sal & Mary Alessi, NNJSDA Presidents

**NORTHERN NEW JERSEY SQUARE
DANCERS ASSOCIATION**

Mid-Term Student Dance - Sun., Jan. 25, 1998
and
The Graduates Ball - Sun., April 26, 1998
at
Newark Academy
91 South Orange Ave., Livingston, NJ
2:00 - 5:00 p.m.

Featuring Callers Teaching Classes at NNJSDA Clubs

Sponsored by the Association for all Students, Angels,
Teachers, Class Coordinators, and Club Members.

Soft-soled shoes required.
Wear your name badge.
Map on page 59.



For information call:

Richard & Linda O'Keefe 973-243-0192
Sal & Mary Alessi 973-256-1647

NNJSDA CALENDAR OF EVENTS

January:

- 25 Mid-Term Student Dance**
Newark Academy,
Livingston, NJ; Many Callers
- 31 NNJSDA Special Dance (PL)**
Mike Callahan & Karen Kushla
Scottish Rite, Lincoln Park, NJ

March:

- 8 NNJSDA Exec. Bd. Mtg.**
- 17 Grand Square Deadline** for
May-Sept (Grads/Summer) Issue

April:

- 26 NNJSDA Graduates Ball**
Newark Academy
Livingston, NJ; Many callers

May:

- 3 Delegates Meeting**
VFW Elmwood Park, NJ
- Grand Square Distribution** of
May-Sept. (Grads/Summer) Issue

- 30 NNJSDA Special Dance (PL)**
Red Bates & Mary McGee
Scottish Rite, Lincoln Park, NJ

June:

- 24-27 47th NSDC**, Charlotte, NC

July:

- 17 Grand Square Deadline** for
Sept-Jan. (Fall) Issue

August:

- 1 Docking Dance (MS/PL/A/RD)**
Crestwood Village
Whiting, NJ
- 29 NNJSDA Warm-Up Dance**
Grand Square Distribution of
Sept.-Jan. (Fall) Issue

September:

- 20 Delegates Meeting**
VFW Elmwood Park, NJ

November:

- 8 NNJSDA Mini-Festival**

'ONE SQUARE IS FAIR'

RUMOR CONFIRMED: NJ CONVENTION POSTPONED FOR 1998



It's true! In 1998, the Square Dance Council of NJ will forego holding the State Convention. Refunds will be mailed to dancers who pre-registered for the Convention.

The Council is foregoing the Convention to sponsor a "Docking Dance" in support of the 49th National Convention scheduled for Baltimore in the year 2000. Regional dances in support of a National Convention are held to increase awareness of the Convention and raise the all-important, up-

front money needed to finance such a huge event.

The Docking Dance will be held on Saturday, August 1, 1998 from 1:00 to 9:00 p.m. in Crestwood Village, Whiting, NJ. The program will feature Mainstream, Plus, Advanced, Rounds, and Contra dancing in three air-conditioned halls. The program features 12 callers, 5 cuers, and other leaders.

Tickets are \$10 per person in advance and \$12 at the door. Look for flyers or call Rich & Georgi Flandera at 973-427-2889.

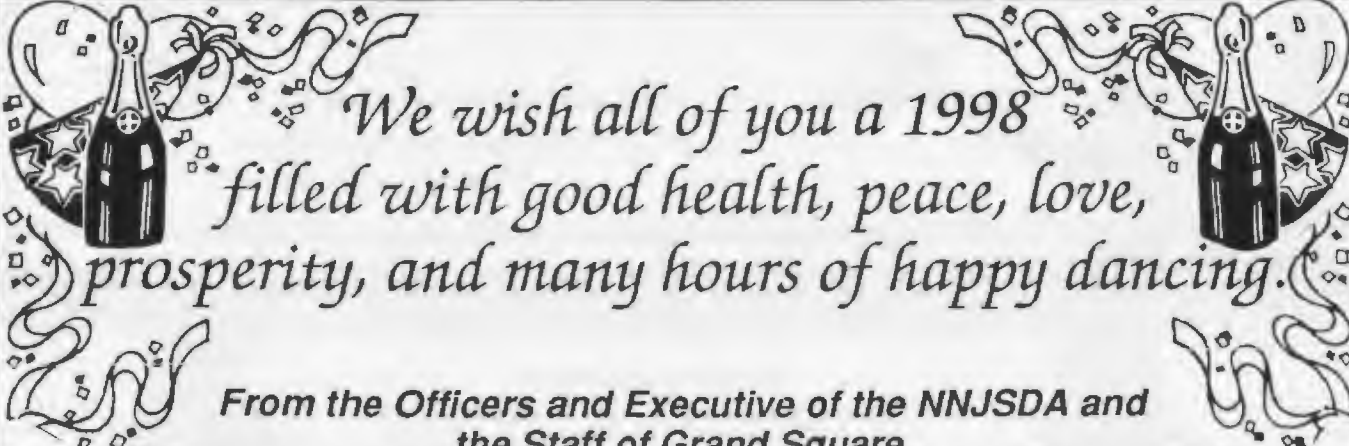

*We wish all of you a 1998
filled with good health, peace, love,
prosperity, and many hours of happy dancing.*

*From the Officers and Executive of the NNJSDA and
the Staff of Grand Square.*

LETTERS TO THE EDITORS. . .

Having been in square dancing for a combined 70 years (Betsy, 45; Roy, 25), we literally have no close friends who do not square dance or did not square dance at one time or another. We have always known that square dancing isn't just about the dance, but about the people who make up the activity.

1997 has been a year that we would like to forget, but is one that we will always remember. Medically, we would like to forget 1997. In April, at the age of 46, Roy had to have one knee replaced (the last hope after a long string of previous surgeries), and in July, Betsy started an ordeal from which she is still recovering. She spent 7 weeks in the hospital (4 weeks in intensive care; 1 week on life support), 2 more months at home, and she lost a large portion of her pancreas. Emotionally, we will always remember 1997, not because of our personal ordeals, but because the outpouring of love, prayers, concern, support, and help was absolutely overwhelming.

While Roy's surgery is fairly commonplace, he still received an abundance of cards, letters and phone calls. Clubs called to make sure he didn't rush his recovery just to cue a dance, and fellow cuers called to make sure his dances were covered. People still ask how the knee is doing.

It was Betsy's ordeal however, that has truly humbled us. She received close to 400 cards and letters, 15 flower arrangements, and 4 fruit baskets. There were phone calls from every part of the USA and Canada. People in the tri-state area offered Roy help with food, transportation, housing, and financial assistance. Friends helped keep other friends informed with phone and Internet networks. When Roy was seeking advice on transferring Betsy from one hospital to another, he received phone calls from surgeons (who square dance) in Texas, Pennsylvania, New Jersey, and North Carolina. When Roy was arranging substi-

Please turn to page 9

NORTHERN NEW JERSEY SQUARE DANCERS ASSOCIATION

Presents

Caller from
New York
PLUS PROGRAM

Mike Callahan

Cuer from NJ
on Rounds

Karen Kushla

Dance Date/Time

**Saturday, January 31, 1998
8:00 p.m. - 10:30 p.m.**

Location

**Scottish Rite Masonic Temple
99 Two Bridges Road
Lincoln Park, NJ (Map on page 58)**

Dress Code

Square Dance Attire. Soft-soled Shoes.

**All Clubs Expected
to Participate**

One Square is Fair

Inquiries

**Jim & Barbara Thoma 718-948-3056
Sal & Mary Alessi 973-256-1647**



30th Anniversary Dance

Saturday, April 25, 1998

5:30 Hor D'oeuvres

6:00 Dinner

7:30 - 11:00 Dancing

Warren Grange Hall

Broadway, New Jersey



Squares by:
Lou Flego
Northport, NY

Mainstream, Plus and Round Dances

\$30 per couple

Deadline for tickets -- April 15

Rounds by:
Elaine Novak
Allentown, PA

Information: Wasser (908) 689-6462 or (908)689-0773

Raimondo (908) 852-2164

Yager (908) 852-8807

Soft soled shoes a must

For tickets, clip and mail to: Dr./Mrs. Louis Wasser, 46 Pleasant Valley Road, Washington, NJ 07882

Name _____ # _____ @ \$15/person _____
Address _____ # _____ @ \$30/couple _____
City _____ State _____ Zip _____ Total enclosed\$ _____
Phone _____

GS

Please make checks payable to Warren Wheelers Square Dance Club and enclose SASE.

NNJSDA POSTER CONTEST

OBJECT OF THE CONTEST: TO STIMULATE INTEREST IN SQUARE DANCING.

1. **Anyone is eligible to enter whether or not they are square dancers.** Any number of entries may be submitted.
2. **All posters must be 8-1/2" X 11" done in black ink on white paper or poster board.**
3. **Subject may be any square dance theme, but must include:**
 - a. National Square Dance Month—September
 - b. Sufficient space left for each club to fill in their own class or open house information.
4. **The subject matter must not be localized to any one geographical area.**
5. **Judging will be the responsibility and honor of the NNJSDA Executive Board at its Sunday, June 7, 1998 meeting.**
6. **All entries, including the winning poster, will become the property of the NNJSDA, and at their discretion be reprinted to promote square dancing in New Jersey, New York, Pennsylvania, and displayed at National and State Square Dance Conventions.**
7. **The winning poster will be featured on the cover of the Fall Issue of *Grand Square*.**
8. **Deadline for all entries is Saturday, May 23, 1998.** Mail or deliver entries to the 3rd VPs, Bill & Elsie Beebe, 405 William Street, Boonton, NJ 07005; Tel: 973-335-0127.

NORTHERN NEW JERSEY SQUARE DANCERS ASSOCIATION

Presents

Caller from
FL & MA
PLUS PROGRAM

Cuer from PA
on Rounds

Dance Date/Time
Location

Dress Code
All Clubs Expected
to Participate

Inquiries

Red Bates
Mary McGee

Sat., May 30, 1998 - 8:00 p.m.

Scottish Rite Masonic Temple
99 Two Bridges Road, Lincoln Park, NJ
(Map on page 58)

Square Dance Attire. Soft-soled Shoes.

One Square is Fair

Jim & Barbara Thoma
718-948-3056

Sal & Mary Alessi
973-256-1647





SOUTH OF THE BORDER

DINNER DANCE

MARCH 15, 1998

**JOE
FIORETTI**
Homosassa, FL

ROUNDS
BY
MARY & JACK
PICKETT
\$22.00
Per Person

**RANDY
PAGE**
Danbury, CT

PLUS 2 P.M. TO 7:30 P.M. **MAINSTREAM**
VASA PARK
BUDD LAKE, N.J.

Sponsored by
Kittatinny Rangers

Make checks payable to Kittatinny Rangers by March 1, 1998
Send to: John & Joanne Morales, 495 Stanhope Rd, Sparta,
N.J. 07871 - 973-398-7323 or 973-663-0123.

GS

Persons Attending:

Name(s) _____ Amt. \$ _____

Address _____ Tel. _____



RALPH STAPENELL

your hall - my call

215-794-8180

Letter to the Editors continued from page 5

tutes for Betsy's dances, the clubs and fellow professionals pretty much said, "You worry about Betsy; we'll take care of the rest." And when Roy just needed someone's shoulder to cry on, there always seem to be someone there.

When people ask us about square dancing, in addition to the standard responses, we have always talked about the global network of friends and contacts. We have always talked about social aspects of our activity. It was never more true than in the past months.

It is very difficult to put into words what we are trying to say. We hope that our example will encourage you to rethink how you present our activity to non-dancers. We hope that you will see that the "big picture" is more important than some smaller squabbles. But most of all, we hope that you, our square dance friends, will accept our sincere and humble thanks. You have reaffirmed our faith in human nature in general, and the square dance community in particular.

With sincere thanks,

Roy & Betsy Gotta



Callers Council of New Jersey

Presents the 23rd

Annual Spring Dance

Class Level Dance

Sunday February 22nd

2:00 - 5:00 PM

Members of the Council Calling

Elmwood Park VFW Hall - Elmwood Park NJ

see any CCNJ caller for tickets

info (718) 624-5665

It is healthier to see the good points of others
than to analyze our own bad ones.

TENAKILL

TWIRLERS

Bryan School, Brookside Ave. Cresskill, NJ
THIRD FRIDAYS

Mainstream with one Plus Tip

Pre-Rounds 7:30-8:00 - Cuer: Nick Raspa
Squares 8:00-10:30

February	20	Dan Koft
March	20	Howard Richman
April	17	Dick Mazziotti
May	15	Nick Martellacci
June	12	Moonlight on the Hudson

President: Gloria Fodera 201-385-8869

Info: George Meyer 201-385-3263

This season club news will be alphabetical order from A-Z.

AL'e'MO SQUARES -- Brooklyn, NY **MS/PL tips**

2 & 4 Sun. Sept-June **Our Lady of Grace Church, Ave W & East 4th St.**

On August 23, Al'e'Mo participated in Brooklyn's first annual County Fair, which gave us an opportunity to demonstrate square dancing to a large audience. On September 10 and 17, we held open houses to introduce people to square dancing. We picked up about 30 students for our new class.

On Saturday, September 27, our club participated in the Marine Park/Gerritsen Beach Parks appreciation day festival. Don called the squares and Dot called line dancing tips. We had a great time demonstrating our square dancing skill, and helping the local people to learn some of the basic calls.

In further pursuit of our mission of combining good times with public service, we continue to collect clothing for Battered Women's groups and for the Veterans at Fort Hamilton Hospital. At our October 26 dance, we collected food for the needy.

It is a great feeling to be able to combine fun of square dancing with the pride of public service. We give thanks to our callers, Don & Dot Coy, who contribute much of their time and talent gratis and to our dynamic Presidents, Vincent Nunziato & Caroline Parlato. We also owe a debt of gratitude to our members who give freely of their time to dance at our public demos and our in-house, fund-raising events.

Ad on page 60

Walter Lasky

718-996-5848

It isn't the mountains ahead that wear you out;
it's the grain of sand in your shoe

SPINNING WHEELS *of* WAYNE

MAINSTREAM EVERY MONDAY NIGHT - WAYNE CIVIC CENTER - 8:00 to 10:30

* INTRODUCTION TO PLUS / 8:00 to 8:30
 * REFRESHMENTS PROVIDED BY MEMBERS

* THIRD TIP, PLUS
 * WESTERN DANCING WITH DOLORES

CALLER SCHEDULE

JAN	5	Bob Robinson	Welcome 1998 Dance
	12	Mickey McFarland	
	19	NO DANCE	Civic Center Closed
	26	Bob Robinson	
FEB	2	Bob Robinson	
	9	Bob Mitchell	Valentine's Day Dance
	16	NO DANCE	Civic Center Closed
	23	Marion Pearce	
MAR	2	Bob Robinson	
	9	Stuart Summers	
	16	Bob Robinson	St. Patrick's Day Dance
	23	Herb Conklin	
	30	Fred Weiner	Chinese Auction
APR	6	Bob Robinson	Easter Bonnet Dance
	13	Don Coy	
	20	Bob Robinson	
	27	Andy Woerner	Pie Night
MAY	4	Bob Robinson	Mother's Day Dance
	11	Dick Pasvolsky	



INTRODUCTION TO PLUS offers, **ALL SQUARE DANCERS**, the opportunity to learn the **CALLERLAB** plus program from varied callers. One plus figure from the previous week is reviewed and one new figure is introduced.

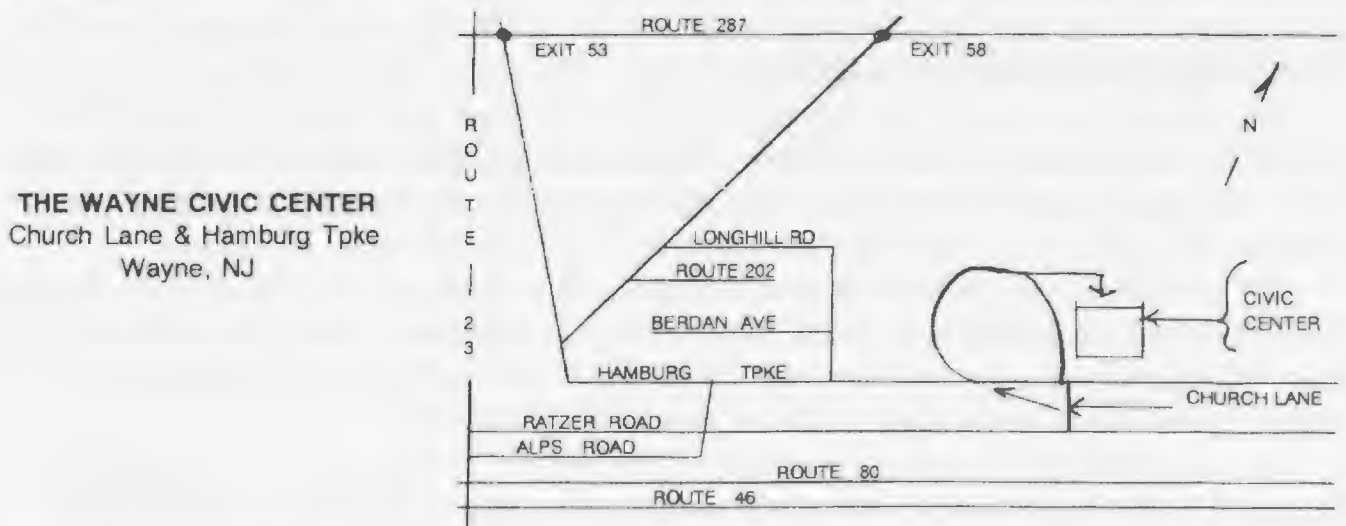

DIRECTIONS FROM ROUTE 287 N or S: Take Exit 53 in Pompton Lakes. Turn Right at the bottom of the ramp. Not counting this traffic signal drive 5.5 mi through 12 traffic lights (follow Hospital signs). Immediately after passing through the 12th light turn Right into the Church Lane Jug-Handle, cross over Hamburg Tpke (Civic Center will be on a right diagonal) and turn into the Jug-Handle on the opposite side of Hamburg Turnpike. Go 3/4 of the way around this second leg of the Jug-Handle and turn left into the Civic Center parking lot.

SPINNING WHEELS SQUARE DANCE CLUB * A GREAT PLACE TO DANCE

FOR INFORMATION CALL: DOLORES GESUMARIA (201) 337-8365 or KATHY & HOWIE STEENSTRA (201) 694-2191

Health is the thing that makes you feel
that now is the best time of the year.

★ ★ The Gottas at Cherry Ridge ★ ★ ★

Honesdale, PA

2 Weekends for Your Enjoyment

A-2
WEEKEND



BETSY GOTTA

ROY GOTTA

July 17, 18, & 19 1998

Only \$110 / Couple
(\$82 / Camping Unit)

Labor
Day '98

Mike Jacobs

Betsy Gotta

Tom Miller

Only \$159 / Couple
(\$117 / Camping Unit)

Aug 31 -
Sept 3, 1998

*On site housing (for non-campers)
*full RV hookups *or local motels

Plus & Advanced
(2 Halls During the Day)

To Register - call 732-249-2086

BEE SHARPS -- Bridgewater, NJ

PL

2 & 4 Fri. Sept-June United Methodist Ch, Country Club & Van Holten Rd.

We had seven new graduates this past season. Their names are Walter Anglum, Agnes & Patricia Greci, Irene Johnsen, Maria Light, Jim Novak, and Dot Van de Voarst. Clem & Fusako Yeager, who returned to square dancing, also graduated. They all graduated with honors, Bee Sharps badges, and the knowledge of Mainstream and Plus.

Our open house was in September and we had 4 squares. A good three-quarters were brand-new students. Almost all the Bee Sharps members were there as angels, and believe it or not, the new students are still coming back for lessons. This is a good sign that they will be future Bee Sharps members.

We've had a good showing at our dances this season. Our Halloween dance was a success as almost everyone showed up in costume. Ed & Grace Klein and Beth Fallat looked great in their costumes. They won prizes too. Everyone was so colorful and some were spooky too. The dancing was fun.

At our first square dance, we had a surprise. Our treasurer, Bill Smythe, got engaged to Holly Smeltzer. He even got on his knees to ask her to marry him in the middle of the tip when the caller was calling "Flip the Diamond." It surprised us all, including Holly. What a rock she got. Wow!!!

By the time you read this, we will have had our Thanksgiving turkey, Santa will have visited, and we will have celebrated a happy New Year 1998. Boy, this year surely went fast. Hope all of you had happy holidays and may it be a good and healthy New Year 1998 for all of you.

Ad on page 30

Olga & Ted Pichnarczyk

908-725-0955

BELLES & BEAUX -- Glen Rock, NJ**MS/PL tip****1 & 3 Wed. Sept-May****Coleman School, 100 Pinelynn Rd.****2 & 4 Tues. June-Aug.****VFW Hall, 6 Veterans Pl., Elmwood Park**

At the time of writing this, less than six weeks remain to the event that everyone has been eagerly awaiting: our New Year's Eve celebration. Canceled last year, this year's festivities have something for everyone and with a caller like Dan Koft, who has been calling since 1979, the evening will be interesting and challenging. Tickets are selling briskly from all reports, and there is a general feeling that this event will be a memorable experience.

Our much-postponed Mystery Bus Ride is now planned for the spring. This bus ride is always a big hit. On our last ride to Pennsylvania, two busloads of people danced with the Dixie Derbys and visited a magnificent cathedral. During the next few months, please watch for our flyers at club dances for more specific information or see our ad in this issue.

Our student class is coming along nicely. This year we have twelve eager students and with the help of our dedicated angels, we can usually come up with three or four squares.

Our raid program, under the capable leadership of Cindy Alberts, is also coming along well. By the end of this month, more than half of our raid requirements should be completed.

Among other news items: David & Lenore Libeskind recently celebrated their 19th Anniversary. Dorothy & Bob Zuiderveliet visited China. "We saw a lot of fascinating things," says Bob, "but it was a grueling trip."

Our condolences to Ruth Gardner on the death of her father.

Ad on page 15, 28

Greg Fokszy

973-403-1854



Ocean Waves



Staten Island University Hospital South ~ Cafeteria
375 Sequine Ave
Staten Island, NY

Mainstream with a Plus tip

1st & 3rd Fridays 8:00 to 10:30 PM

<u>Date</u>	<u>Caller</u>	<u>Date</u>	<u>Caller</u>
February 6	Dan Koft	February 20	Howard Richman
March 6	Marion Pearce	March 20	Dan Koft
April 3	Don Coy		
May 1	Dick Mazziotti	May 15	Howard Richman
June 5	Don Coy	June 19	Steve Forman

Students are Welcome !!!

Contacts

Lisa Oshins 718-317-7360
Michael Pierce 718-833-2146

CIRCLE EIGHTS -- Haworth, NJ

MS/PL tip

4th Fri. Sept-June

St. Luke's Episcopal Ch., Mass. & Grant Aves.

We started off the new fall season with a very successful Open House on September 22. Approximately 80 people attended, including most of our Circle Eights members and some angels from Tenakill Twirlers. Belles & Beaux, and F.A.D. among others. It was a wonderful evening, and about 25 of those who attended are now enrolled in our class, taught by Andy Woerner.

Our first dance of the season, called by Gerry & Chuck Hardy, was also very well attended and proved to be an evening of good dancing.

On October 26, we hosted our 4th Annual Autumn Leaves Dance. Unfortunately, because of heart surgery, our scheduled caller, Randy Longobucco, could not make it. But he arranged for Will Larsen to take his place. Most of us in this area are not familiar with Will, but were pleased to have an opportunity to dance to a very talented caller. There was an abundance of tasty food thanks to the efforts of the co-chairladies, Betty Wilson and Barbara McKenna. Lois Bichler's line dancing was enjoyed by many who attended, and there was a lot of shopping thanks to Bolos-N-Petticoats. The sound system was terrific this year, a big improvement over past years.

We wish all our square dance friends a very happy and healthy New Year filled with lots of good dancing and fellowship. We hope to see you at our dances every fourth Friday from now through June. See our ad for dates and callers. We guarantee you a fun-filled evening.

Ad on page 21

Rudi Draudin

201-768-9324

Mot ivgors

Jewish Community Center of Paramus
Midland Ave. & Spring Valley Rd - Paramus, NJ
Hall Phone: (201) 262-9860

A-2 Level Dancing - Sundays 7:30pm to 10:00pm

Nick & Carole Raspa on Rounds starting at 7:00pm
C-1 Aftertip unless otherwise noted (*)

*** Winter/Spring 1998 ***

Jan. 4	Lou Flego	•March 22	Anne Uebelacker **
Jan. 18	Todd Fellego	•March 29	Dave Wilson
Jan. 25	Sam Lowe	April 5	(Palm Sunday-No Dance)
Feb. 1	Mike Jacobs	April 19	Randy Page
Feb. 15	Geo Jedlicka	May 3	Shane Greer
March 1	Todd Fellego	•May 17	TBA

• Location To Be Announced (Watch For Flyers or Call)

** *Mary Picket on Rounds*

Steve and Grace: (201) 568-6418
Beth: (718) 601-1902

Sid & Marianne: (908) 757-8374
George and Fanny: (201) 385-3263



Why not try realistic resolutions this year?



Belles & Beaux Square Dance Club

**Yes! There will be a MYSTERY BUS RIDE in 1998
Watch for flyers
Ride to take place in April or May
(Don't you just love a good mystery?)**

COUNTRY PROMENADERS -- Edison, NJ PL
2 & 4 Sat. Sept-May Stelton Comm. Ctr., Plainfield Ave. (Rt. 529)
Alt. Site: First Presbyterian Ch, 117 5th Ave, Roselle

We would like to extend a big welcome to our new members: Irene Freiberg, Steve Gazdek, Barbara & George Kuhne (4 of our new graduates), and Chris & Don Randolph (former Merri Eights). Along with friends from Y Squares, we put on a demo at Woodbridge Cultural Day, representing the official folk dance of New Jersey. We raided Harmony Dancers under the leadership of our chaircouple, Hank & Lillian Comeau.

Our 45th season opened with Pete Diven both calling and cueing for a hall full of appreciative squares, followed by Ed Foote's inimitable sense of humor. Our Halloween dance with Jim Snyder found Mickey & Minnie Mouse, Dorothy and the Scarecrow, and a snow leopard and orangutan dancing in our squares. A pair of sharp bees were part of a club by the same name. Mike Callahan did an excellent job entertaining us for an evening and getting us warmed up for the Mini-Festival. Glenn Matthew called and Steve Bradt cued at our 45th Anniversary Gala. Some members of the NNJSDA Executive Board joined us as we celebrated this special milestone. Recognition was given to Past Presidents who were able to attend including boutonnières and picture-taking. Joe Landi and Mark Franks, some considerable talent from South Jersey, kept us warm and hopping.

We sincerely appreciate the raids of Bee Sharps, Harmony Dancers, and Valley Squares. With the lower attendance at so many clubs, raids really do make the difference. Hope to see you in a square soon! Remember, singles are always welcome at our club, and we do our best to keep you dancing through the evening.

Ad on page 51

Jan & Louis Thompson

732-577-9413

CROSS TRAIL SQUARES – Caldwell, NJ

PL

2 & 4 Wed. Sept-June

Lincoln School, Crane St.

Put on those booties 'cause it's getting cold outside! What better way to warm up a cold night than to square dance with old friends and friends you just met. CTS is off and running through another year of "fun and friendship" with our typical verve and panache (I knew that thesaurus would come in handy). Our raid schedule is under way and we had the pleasure of sending 10 dancers to Harmony Dancers and 19 dancers to Hix & Chix. Be on the lookout for us because we do enjoy raiding *en masse*.

We also like to show off our stuff (and cast our nets for new members) by doing demos whenever we can. We were on hand for a demo in Lincoln Park on their community day, did our now-traditional stint on Labor Day in Verona, and showed off our fancy moves for the Knights of Columbus in Little Falls.

Our dances have been well attended so far and club caller, Bob Mitchell, along with our guest callers, have kept the tips fresh and challenging. I've noticed that Bob and the callers have gotten better at calling what I'm dancing.

We have a class running under the able direction of Ron Kapnick. Be on the lookout for us at student dances. With that in mind, a suggestion to all of our friends: Please try to attend some of the student dances and encourage the new dancers. I remember the help and encouragement I got when I was starting out, and I know I am not alone in believing that without the help of veteran dancers, I would not still be dancing today. Also, you can relearn "Circle to a Line" and other Mainstream calls that you either no longer do correctly or forgot (did anyone say spin chain thru?). So come visit us on a Wednesday night, you'll be happy you did and remember "any tip you can walk away from is a good tip."

Ad on page 42, 66

Frank & Alice Lemire

201-783-1683

Y SQUARES

2 & 4 Fridays

Carl Kumpf School, Mildred Terrace, Clark, NJ

7:30-8:00 p.m. Rounds

8:00-10:30 p.m. Squares & Rounds

Soft-soled shoes required.

DATE	THEME	CALLER	CHER
Jan. 23/98	Super Bowl	Dick Mazziotti	Karen Kushla
Feb. 13/98	Pie Night	Dan Koft	Karen Kushla
Feb. 27/98	Pres. Night	Joe Landi	Karen Kushla
Mar. 13/98	St. Patty's	Dan Koft	Karen Kushla
Mar. 27/98	Spring Fling	Frank Riviccio	Karen Kushla
Apr. 10/98	NO DANCE --- EASTER		
Apr. 24/98	Hoe Down	Dick Pasviosky	Karen Kushla

Directions to Carl Kumpf School: GSP exit 135; west on Central Ave. At first light turn left on Raritan Rd; at third light turn left on Madison Hill Rd. Third street on the right is Mildred Terrace. Go a half block to school entrance on the left.

Information: Jean & Joe Magnani (908) 756-0268

Jean Koenig (908) 276-8049 Leave message

Hall phone (732) 574-8354

F.A.D. SQUARES NEW DANCE HOURS 7:30-9:30 pm

1st & 3rd SUNDAYS
MAINSTREAM W/PLUS TIP
AND WESTERN DANCING

PARAMUS CONGREGATIONAL CHURCH
205 SPRING VALLEY ROAD
PARAMUS, NEW JERSEY 07652

WINTER/SPRING - 1998

- JAN 18 - PAL JOHNSON
- FEB 1 - CHUCK HARDY - CLASS LEVEL DANCE
(ALL STUDENTS WELCOMED @ \$2.00 ea)
- FEB 15 - NICK MARTELLACCI
- MAR 1 - RON KAPNICK & RUTH EDISON - CLASS LEVEL
DANCE (ALL STUDENTS WELCOMED @ \$2.00 ea)
- MAR 15 - DICK PASVOLSKY
- APR 5 - FAD 15th ANNIVERSARY DANCE - COME HELP US
CELEBRATE - CALLER: STUART SUMMERS
- APR 19 - MICKEY McFARLAND - NEW GRADUATES DANCE
(ALL NEW GRADUATES or ABOUT TO BE ARE
WELCOMED @ \$2.00 ea)
- MAY 3 - NICK MARTELLACCI
- MAY 17 - DICK MAZZIOTTI & Amateurs
- Jun 7 - MICKEY McFARLAND



PLEASE:
SOFT SOLE
SHOES

AT F.A.D. WE DO "SUBSTITUTIONS"
SO EVERYONE GETS TO DANCE



"PROPER SQUARE
DANCE ATTIRE
PLEASE"

FOR INFORMATION CALL:

DOROTHY: (201) 447-4964
DICK/BRENDA: (201) 529-3372
CHURCH: (201) 261-4166

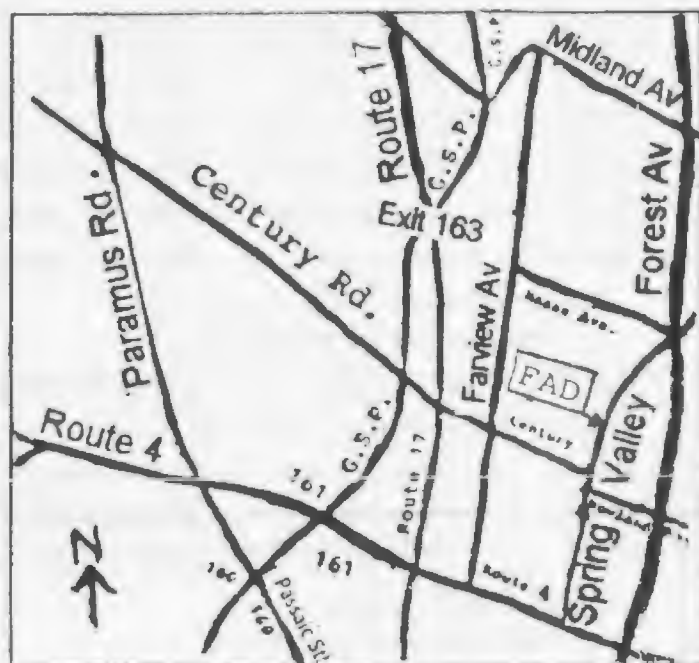

DINGMAN DANCERS -- Milford, PA

MS/PL tip

2 & 4 Tues. Mar-Jun & Sept.-Dec
Jun-Aug

Delaware Valley H.S., Routes 209 & 6

American Legion Hall, Milford Rd & Christian Hill Rd

Once again we held our Christmas in July dance hosted by Jane Frey. The refreshment table carried out the theme with red velvet bows and other decorations. A twinkling light wreath really added to the holiday spirit. Rich Murphy had us dancing to Jingle Bells before the evening ended. The colors of red and green worn by many of the dancers really made it feel like Christmas.

Casual dress was appropriate for our Beach Party dance in August. Members provided hot dogs, sauerkraut, and salads. Just imagine what fun it was to Do Sa Do and Allemande Left to the music of the Beach Boys.

Our September School Days Dance was another winner. Everyone received a Looney Tunes paper lunch bag. Inside each bag was a peanut butter and jelly sandwich, a banana, chips, animal crackers, and a lollipop. On the refreshment table there was an open lunch box containing chips and a dip. Door prizes that night were either a package of pencils or a memo pad. Our compliments to Judy & Charlie for their originality and a job well done.

Presidents Betty & John Rigo hosted our Ice Cream Social. John made the lemon ice and vanilla ice cream. There were toppings of nuts and syrup from which to choose. We were happy to see Al Bravin who dropped in for a visit. He has been on the sick list for a while. Al, we hope to see you back on the dance floor soon.

Our Octoberfest was hosted by Marianne & Ken Yeaw. Refreshments included Black Forest Cake and large soft pretzels with a mustard dip. We wish to thank Mickey McFarland for filling in for Rich at our Halloween dance.

Happy New Year to all!

Ad on page 49

Millie Connelly

717-588-9226



1st AND 3rd FRIDAYS

7:30 PRE ROUNDS

8:00 PLUS LEVEL

IRONIA REELERS

IRONIA SCHOOL, (RT 513) DOVER

CHESTER ROAD, (IRONIA) RANDOLPH

DATE:

02/06

CALLERS:

Joe Landi

CUERS:

Mary Pickett

02/20

Randy Page

Mary Pickett

03/06

Burt Schain

Mary Pickett

03/20

Jim Snyder

Mary Pickett

04/03

Joe Landi

Mary Pickett

Dinner Dance At: Mt. Fern Church

Reservations Necessary

04/17

Don Coy

Mary Pickett

At: Randolph Senior Center

05/01

Ken Rituci

Dave Roberts

05/15

Lou Flego

Kathy Koft

06/05

Bob Mitchell

Kathy Koft

Covered Dish Supper

(must sign up & contribute)

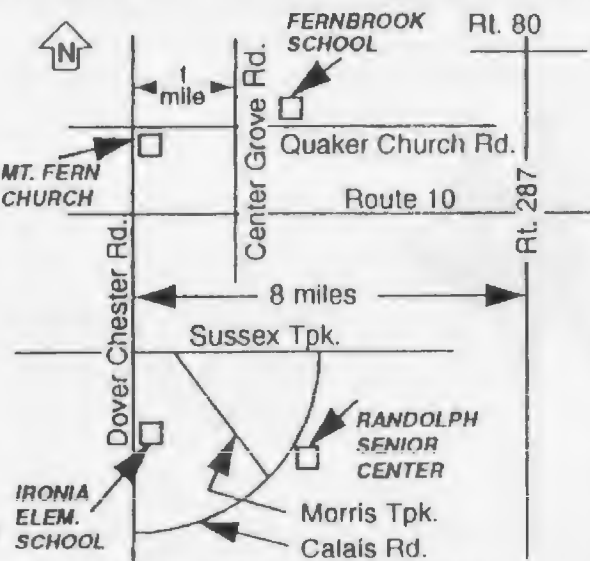

FOR MORE INFORMATION CALL:

Mary Jane & Greg Roome 973/543-4109

or

Eileen & Bill Ebell 973/895-2653



Warren Wheelers



8:00 to 10:30 - 1st and 3rd Thursdays

Mansfield Township School, Rt. 57, Port Murray, NJ
(Just 6.8 miles west of the junction of Rts. 24 and 57)

1998

Feb 5 Ed Kerns
Feb 19 Dick Pasvolsky▲
Mar 5 Dick Mazziotti
Mar 19 Dick Pasvolsky
Apr 2 To Be Announced



1998

Apr 16 *No Dance*
Apr 25 Dinner Dance▲▲
May 7 Herb Conkln
May 21 Dan & Kathy Koft*
Jun 4 Wilson Hoff
Jun 18 Dick Pasvolsky**

▲ President's Dance

▲▲ 30th Anniversary Dance See our other Ad this issue

* Rounds by Kathy Koft

** Covered Dish Dinner before the dance

Information:

Wasser (908) 689-6462 McGinley (908) 852-0824 School # (908) 689-9856

F.A.D. SQUARES -- Paramus, NJ

MS/PL tips

1 & 3 Sun. Sept-June

Paramus Congreg. Ch, 205 Spring Valley Rd.

On November 2, Belles & Beaux raided us and Dick Mazziotti was the caller. On November 19, F.A.D. in turn raided B & B.

Starting in January 1998, F.A.D.'s dance hours will be changed to 7:30-9:30 p.m. (instead of 7:00-9:00 p.m.). The 7:30 p.m. time is more convenient. The first dance under these new hours will be a Class Level Dance on January 4, with Dick Mazziotti as caller. We have a great list of callers for winter/spring 1998.

On April 5, F.A.D. will celebrate its 15th Anniversary. Come help us celebrate on this occasion. We expect a great dance.

Our President, Dorothy Fels, made her annual cruise—this time to Bermuda in October. Speaking of Dorothy, she will complete her fourth and final year as President of F.A.D. in June. So we will need new officers.

Remember, F.A.D. is "Fun At Dancing." See you soon.

Ad on page 17

Marj & Warren Gould

201-445-9896

47th National Square Dance Convention

Charlotte, NC June 24-27, 1998



"Nothing could be finer than to be in Carolina"

PO Box 562814, Charlotte, NC 28256-2814

Tel: 704-566-9664 or 704-566-9770

Fax: 704-563-3265 Web Site: www.iei.net/47nsdc

Rockland Promenaders



Mainstream Dancing

New Night - New Location

Second Friday of the Month

William O. Schaffer School
Lester Drive
Tappan, NY 10983



8:00 p.m. to 10:30 p.m.

1998

January	9	Roy Leber
February	13	Ralph Stapenell
March	13	Bob Bourassa
April	10	No Dance (Good Friday)
May	8	Dick Mazzlotti & Mark Hanhurst Graduation Dance
June	12	See you at Moonlight on the Hudson Dance Alpine Boat Basin

Directions:

From Palisades Parkway North or South: Ext 6W (Orangeburg Road - Pearl River). At first light, turn left onto Lester Drive. *At fork, keep right to continue on Lester Drive. School is approximately 1/4 mile on your right.

From Route 303 North: Turn left onto Orangeburg Road (from Rt. 303 South, turn right). At the 3rd light, (right after PIP signs) turn left onto Lester Drive. Continue from * above.

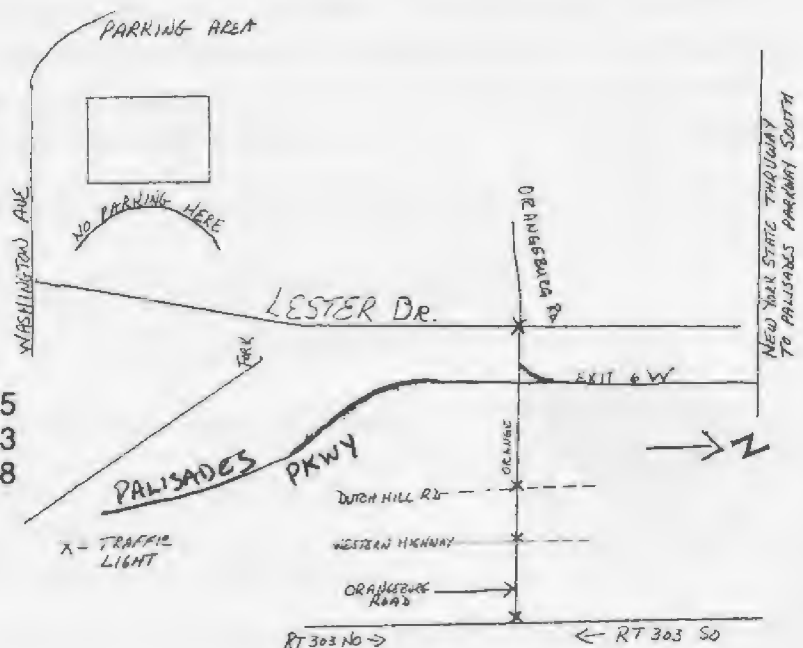

For Information:

Tom & Bonnie Silk
Al & Ilse Dill
Carl Luhrs

914-365-0525
914-359-3943
201-489-2498

HARMONY DANCERS -- Springfield, NJ

PL

1 & 3 Sat. Sept-May

Chisholm Sch., S. Springfield Ave. at Shunpike

Our fall season is well underway. Thanks to all our members and guests who have made the transition to our new location a great success. Dancers have learned that our new site in Mountainside is easy to get to, that parking is plentiful and that the elevator to the second floor is a major plus.

Our first dance displayed our membership in Harmony's vibrant rainbow colors. Special thanks go to Steve Bradt, who pinched in as our cuer for the night when Karen Kushla suddenly came down with a sore throat. Our second dance brought three raiding clubs and two visitors from the Merry Mixers in Tucson, Arizona. We congratulated club members Phyllis & Bill Tallamy upon their recent 50th Anniversary and Bill's 80th birthday celebration.

We are once again joining Country Promenaders, Rutgers Promenaders, Valley Squares and Y Squares for a five-club Mainstream program New Year's Eve dinner dance. We look forward to this enjoyable dancing event with our family of friends for good luck into 1998.

For 1998, plans are underway for our 5th annual afternoon of round dancing with Ron & Ree Rumble to be held on Sunday, January 25. Flyers are being distributed to all clubs with ticket information. We will be conducting DBD/Plus workshops with Howard Richman starting February 1, at our new location. Look for flyers and our ad in this issue. Sign up for several fun-filled sessions and sharpen your dancing skills.

Ad on page 23, 26

Alice & Joe Kaspar

908-232-5078



CIRCLE

EIGHTS

Mainstream
Dancing

For info:
201-385-4299
or
201-768-9324

Our 1998 Schedule

January 23	Howard Richman
February 27	Dick Mazziotti
March 27	Randy Longobucco
April 24	Andy Woerner (Student Dance)
May 22	Pat Push
June 12	Howard Richman (Moonlight on Hudson Dance)
June 26	Mickey McFarland (Pot Luck Supper)

Plus Workshop now being offered during first 1/2 hour of dances with the exception of student Dances. A "Plus" tip will be the last tip of the dance.



COME WITH A PARTNER OR ALONE -
AT CIRCLE EIGHTS EVERYONE DANCES.

Held on the 4th Friday of the month (8:00 to 10:30 PM) at St. Luke's Church on the corner of Massachusetts and Grant Avenue in Haworth

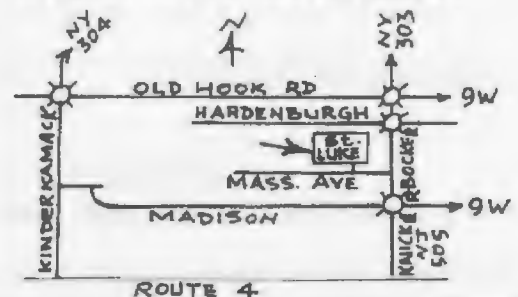

To avoid criticism: Do nothing, say nothing, be nothing.

HI TAW TWIRLERS -- New Milford, NJ

PL

1, 3, 5 Tues. Sept-June

New Milford Middle Sch., Roslyn Ave.

After its summer break, Hi Taw Twirlers started the season in September with Red Bates calling a great dance. Hi Taw Twirlers is continuing to offer dances which are challenging to experienced Plus program dancers yet friendly to inexperienced dancers. See our ad and flyers for details about our full schedule of Plus dances as well as our special A-2 dances. You will find that we have booked a variety of great callers. You will be familiar with some of the names, and others will be new callers who you will enjoy.

Congratulations to Lucille & Richard Behrens on the marriage of their daughter, Lorraine. At our October 21 dance, Hi Taw Twirlers helped celebrate the 50th anniversary of Willie & Esther Taffel. We were recently visited by long-time members, Dave & Adele Weiss, who have relocated to central NJ.

Our use of computer squares has proven to be a great success. The valuable plastic laminated "slips" are very carefully monitored and guarded by our diligent first husband, Ken Weinberg. At our November 4 dance, President Jill Weinberg announced a few times that Ken would collect the slips at the beginning of the last tip. All of a sudden Ken was inundated and smothered by a pile of slips tossed onto his head, which many of our lady dancers had quickly and quietly removed. We all (even Ken) had a good laugh!

Remember our new time: squares begin at 7:30 p.m. sharp (no pre-rounds) and there is an A-2 aftertip at 9:45 p.m.

Ad on page 24

Beverly & Marty Millman

201-391-3592

Kings' Squares

Brooklyn's First Square Dance Club

1st & 3rd Sundays 7:30 - 10:00 P.M.

1998:

Jan. 18	Nick Martellacci	Alumni Dance
Feb. 1	Dick Mazziotti	Presidents' Day
Feb. 15	Dan Koft	Valentine's Day
Mar. 1	Don Coy	Cookie Night
Mar. 15	Jim Emory	St. Patrick's Day
Apr. 5	David Schlyer	Spring is Back!
Apr. 19	Sandy Corey	The Circus is in Town!
*May 3	Frank Riviccio	Graduation
*May 17	To Be Announced	Ice Cream Social
*June 7	Frank Riviccio	Annual Dinner Dance

*Mainstream Dances

For further information:

Pat & Bernie Monsen
Ben & Shirely Friedman

718-745-3616
718-336-1650

Redeemer-St. John Lutheran Church
939-83rd Street (bet. 7th & 10th Aves), Brooklyn, NY

Directions: Belt Parkway to Exit 4 (Bay 8th St/14th Ave). Left at light; left at next light to 7th Avenue to 83rd St.; right on 83rd Street. Church is on left near corner.

From Verrazano: 92nd St. Exit; right to 7th Avenue; left on 7th Avenue to 83rd Street; right on 83rd Street. Church on left near next corner (10th Ave.)



Never put off until tomorrow the hug you can give today.



**HARMONY DANCERS
PRESENTS:**

WINTER WARMUP

D B D

(Dancing by Definition)

PLUS WORKSHOPS

with **HOWARD
RICHMAN**

Sundays

7-9 p.m.

February 15 & 22

March 8, 15, 22, & 29

\$6/Couple

COME
POLISH
YOUR
PLUS

AND
HAVE
FUN

! TOO !

**Mountainside
Municipal Building**
(see our other ad for map)

Info: Alice/Joe Kaspar - 201-889-0372
Marilyn/Ralph Neibart - 973-762-8481
Jude/Roger Remington - 908-322-1879
Corinne/Leo Eckmann - 973-379-3901

HIX & CHIX -- Elmwood Park, NJ

PL

3rd Thurs. Jan-Dec.

VFW Hall, 6 Veterans Place

Happy 1998! And many thanks to all the guests who danced with us in 1997, and to the callers and cuers who made for many a memorable dance. We also send you an invitation to dance with us throughout our 1998 schedule. Hix & Chix will be holding Plus dances the third Thursday of each month, with "specials" added in.

Our bright note for this issue: Happy Birthday to the vivacious Anne Pistono, who, believe it or not, turned 80 in November. The secret to her eternal youth: Vitamins, vitamins, and more vitamins, along with a sensible diet, and, of course, a husband who loves to play cards with the boys.

Dick and I are off again. This time to Florida to visit our grandchildren for the Thanksgiving holidays. Hope your holidays were healthy and happy. And you got everything you wanted for Christmas. Also, we hope you folks took advantage of those wonderful square dancing New Year's parties!

Ad on page 47

Dick & Brenda Dexter

201-529-3372

HI TAW TWIRLERS

PLUS DANCES -- TUESDAYS

A2 AFTER-TIP

New Milford Middle School

Roslyn Avenue, New Milford, NJ

Public Phone: 201-261-9881

FEBRUARY 1998

3 HOWARD RICHMAN 24 NICK MARTELLACCI

MARCH 1998

3 JOHN KALTENTHALER 17 ROY LEBER
31 LOU FLEGO

24 ***KEN RITUCCI (*** SPECIAL A2 ***)***

APRIL 1998

7 TODD FELLEGY 28 JOHN KALTENTHALER

MAY 1998

5 KEN RITUCCI 19 RED BATES

JUNE 1998

2 JOHN KALTENTHALER (*Wear Casual Clothes*)

Squares Start at 7:30

Plus & Rounds 7:30-9:45

A2 9:45-10

Rounds with Cuer Nick Raspa

Info: Jill 914-623-8926
Marty 201-391-3592

SQUARE DANCE GOODIE TABLE ETIQUETTE

For the sake of everyone's health, PLEASE do not be a "toucher" or a "double dipper" at the food table.

Once you "touch" a piece of cake, a finger sandwich, a vegetable, etc., it's yours. It is definitely bad manners to pick it up and put it back.

The "double dipper" takes a vegetable, a cracker, or a chip, slides it in the dip, and takes a bite. Then the "double dipper" re-dips the second half in the dip! This is more than just bad manners—it's downright unsightly and unhealthy.

SQUARE DANCE TRAVEL ETIQUETTE

If you don't drive and someone is nice enough to offer you a ride, you and all other passengers should take care of the tolls. If it's long trip, or one that requires and an overnight stay, all the passengers should chip in an extra few dollars to take care of the cost of the gas.

BUILD CONFIDENCE • SHARPEN SKILLS • REINFORCE LESSONS

BASIC, MAINSTREAM and PLUS

SECOND HALF

PROGRAM VIDEOS

Callerlab approved!



Outside U.S. add \$10. Specify "Payable in U.S. Dollars." Check or MO only.
© 1987-1990 Tra Bien, Inc.

Broadcast quality video tapes. Filmed in television studio, featuring overhead shots.

BASIC
SECOND HALF
(movements 26-50)
\$49⁹⁵

MAINSTREAM
(Callerlab sequence 51-67)
\$39⁹⁵

PLUS
(27 movements)
\$49⁹⁵

Featuring BETSY GOTTA. Caller. 30+ years. Member Board of Governors, Callerlab.



Add \$3.50 postage and handling • N.J. res. add 6% sales tax

Please specify BASIC MAINSTREAM PLUS VHS BETA

Mail check or money order to:



SQUARE DANCE VIDEOS

A Division of Tra Bien, Inc.
P.O. Box 1350, Maplewood, NJ 07040



Name (Please Print) _____

Address _____

City _____

State _____ Zip _____

GS

HUNTERDON FLUTTERWHEELS -- Stanton Sta., NJ Alt MS/PL 1 & 3 Fri. Sept-June Echo Hill, Lilac Drive

Hello square dancers! Flutterwheels are doing well and having a good year. We have a good-size class and our students are learning fast. Art & Shirley Richards are in charge of class and they keep things running smoothly.

At our dance on September 19, we had a real fun night with Mickey McFarland and her adorable pet, QT, who just loved watching us dance and then decided to go off to sleep. Russ Booz was also there to keep things moving.

Pat & Seth Noll came to our dance November 7, with their beautiful new baby girl. Her name is Grace Olivia, and she was born on September 4. She just loved sitting in her reclining seat watching everybody dance around her.

We all enjoyed going to the Mini-Festival and Flutterwheels had a good turnout. Those attending were the Baileys, Davises, Elliots, Kochs, and Schmidts. Everyone said they had a good time and enjoyed seeing so many familiar faces.

The holidays are over now and I hope everyone made some good resolutions regarding square dancing. Attending dances, bringing refreshments, and supporting your club is a good way to start. We love having guests and we invite everyone to come to our dances. See you in a square.

Ad on page 41

Lillian Davis

908-722-1747



PLUS Level Dancing (with some Advanced Tips)

Harmony Dancers

1st & 3rd Saturdays
8:00 to 10:30 p.m.
Pre-Rounds 7:30 p.m.



January - May 1998

Jan. 25--Sunday Afternoon- * * * RON RUMBLE ROUND DANCE * * *
1:30-4:30 pm - 1st Presbyterian Church, Cranford. See flyer or call for info!

Feb. 7 (Advanced Tip @ 10:30) John Kaltenthaler Steve Bradt

Starting Feb. 15 -Sundays-PLUS DBD Workshop-Howard Richman-see ad

Feb. 21 "Welcome Presidents" To Be Announced Mary McGee

Mar. 7 (Advanced Tip @ 10:30) John Kaltenthaler Steve Bradt

Mar. 21 "Think SPRING!" Glenn Matthew Steve Bradt

April 4 "Rubber Ducky Dance" Joe Landi Steve Bradt

April 18 (Advanced Tip @ 10:30) John Kaltenthaler Mary Pickett

May 2 (Adv'd 10:30) "Ice Cream Social" John Kaltenthaler Karen Kushla

May 16 "Pretzels & Beer Night" (Birch) Drew Scearce Russ Booz

See you at the ♣ ♣ ♣ ♣ ♣ Summer Dances

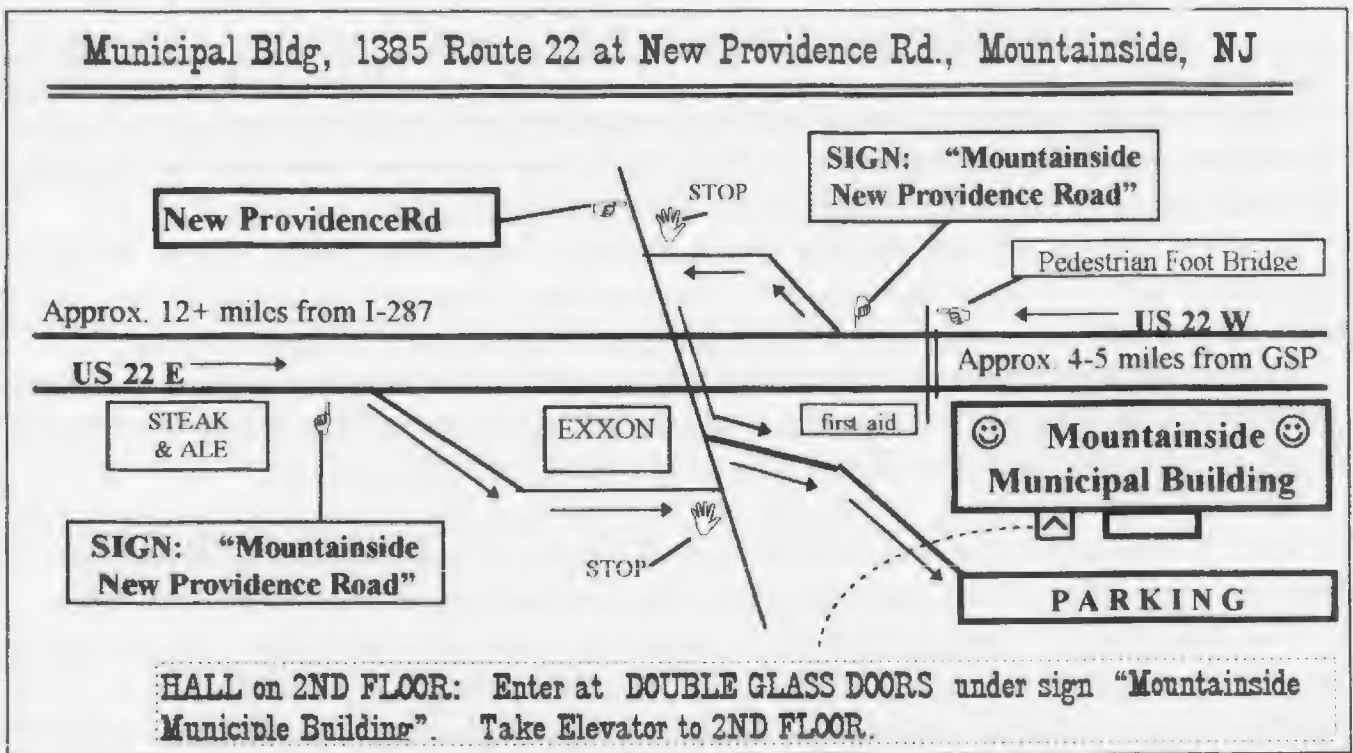

CORINNE/LEO ECKMANN - 973-379-3901 ALICE/JOE KASPAR - 201-889-0372
MARILYN/RALPH NEIBART - 973-762-8481 (wear shoes suitable for cement floor)

IRONIA REELERS -- Randolph, NJ

PL

1 & 3 Fri. Sept-June

Ironia Elem. Sch., Dover-Chester Rd., Rt. 513

Winter solstice—the time when the sun reaches the December solstice for the northern hemisphere. You will be reading this immediately following that event, even though I am writing amidst falling leaves, pumpkins, turkeys, and recollections of pilgrims and Native Americans feasting. Solstice—either of the two points in the sun's apparent annual orbit in relation to the fixed stars (the ecliptic) at which it is furthest from the equator. So you can view this as time for hibernation, white, quiet, cold -OR-you can square dance and bring the light back into your life. Feel the heat while you dance with us at Ironia Reelers. No need to travel south!

Wilson Hoff is offering two sessions of 15-week Plus lessons this dance year. Many Reelers, as well as members from other clubs, have chosen to improve their skills. Although this is not a club-sponsored function, some of our Board Members have answered the call for angels to complete the squares.

Our Presidents have returned from a European summer holiday, where Mary Jane succumbed to a minor illness. Whilst in Finland, it happened she was treated by a veterinarian. Thankfully, she quickly overcame that "sick as a dog" feeling and returned to her vivacious self, laced with natural quick wit. However, be cautious anyway now in her square, lest she "put the bite on you." Just "bear" with her if she can't resist giving you a "cat scratch" on the back, and keep all that "horsing" around under control.

Ad on page 18

Eileen & Bill Ebell

973-895-2653

>>>> Spring 1998 Dancing Schedule <<<< **Western Wheelers S/D Club**

>>>> **Second & Fourth Saturdays** <<<<THE REFORMED CHURCH of ORADELL
Hall 201-261-1720641 Church Street @ Kinderkamack
Oradell, N.J.

Pre-Rounds 7:30

PLUS DANCING

8:00-10:30

After Tip @ 10:30

Nick Raspa, Club Cuer

[]	1-24-98	Roy Leber	[]	4-11-98	No Dance
[]	2-14-98	Randy Page	[]	4-25-98	Randy Page
[]	2-28-98	Dick Mazziotti	[]	5-9-98	Don Coy
[]	3-14-98	Don Coy	[]	5-23-98	No Dance
[]	3-28-98	To Be Announced	[]	6-13-98	No Dance

Mark Your Calender
dance with Western Wheelers
the Friendly Club

INFORMATION: 201 / 261-3921, 569-9120 or 391-1953

40th NEW ENGLAND CONVENTION

April 24-25, 1998

Registration Chairman: John & Sue Sullivan 508-443-9636

KINGS SQUARES -- Brooklyn, NY

PL

1 & 3 Sun. Sept-June

Redeemer St. John Ch., 939 83rd St.

Challenge! Challenge! Challenge! A square dance program to many, but in reality a gauntlet placed before the members of Kings Squares. Over the past few weeks we have sorely missed our inspirational leader and caller, Frank Riviccio, due to surgery. At the same time, we had to cancel our Thursday Mainstream and DBD Plus workshops due to this situation. However, despite this adversity, we have maintained the strength of our tradition. We have danced at many clubs, weekends, and festivals while continuing our successful Sunday dances. We are also back to our DBD Plus workshops.

It was nice to dance with the members of Lakeland Squares as they traveled over the moat to that far-away land of Brooklyn. Most significant was the return of Frank as he called with Don Coy at the Welcome Back to Brooklyn Festival co-sponsored with Al'e'Mo Squares. Hats, noisemakers, and a bit of the bubbly topped of our annual New Year's Eve Party.

In addition to traveling to various clubs, we have now ventured on to the information super-highway. An interesting square dance discussion group can be found at <http://www.eclipse.net/~ksr/sdlist.pl> or to subscribe send the line subscribe square dancing your name to macjordomo@eclipse.net. On a personal note, we have found this to be interesting, stimulating, and informative as well as plain fun.

Square dancers truly are like an extended family. We all feel at home wherever we go. Our club is strong and healthy again. We wish everyone, especially Frank, a most happy, healthy, and prosperous New Year.

Ad on page 22 Helanie & Artie Schwartz 718-251-8614; helaine@admin.con2.com

Belles & Beaux

Square Dance Club Mainstream (+tips)

Coleman School, 100 Pinelynn Rd., Glen Rock

Take Route 4 to Route 208, Maple Ave. (Ridgewood) exit; make first right onto Harristown Road. Pass the High School. Pinelynn is the first right turn off Harristown Rd. north of the Glen Rock Jewish Center. Call for other directions!!

1st & 3rd Wednesdays 8-10pm w/Plus Aftertip

Winter & Spring Square Dancing Festival!

February 4—Howard Richman

February 8—Student Dance —Dick Mazziotti and Randy Page

February 18—No Dance Schools Closed

March 4 —Sandy Corey

March 8 —Student Dance —Dick Mazziotti and John Kaltenthaler

March 18 —Dick Mazziotti—Mystery Auction Mystery prizes to bid on!

April 1 —John Kaltenthaler

April 15 —Mickey McFarland—The Tax Man Cometh & a Bake Sale!

April 22 —Graduation—Dick Mazziotti

April 29—No Dance Schools Closed

May 6—Nick Martelacci

May 20—Dick Mazziotti

Questions: Call Margaret (201) 384-2791; Susan (732) 381-8097 or Rich (973) 838-0312



Rutgers Promenaders - North Brunswick, NJ

1998 Schedule

2nd & 4th Thursdays
8:00 pm - 10:30 pm

Callers: Betsy Gotta and/or Dan Koft
Cuers: Roy Gotta and/or Kathy Koft

1998

Jan. 8 Snowflake Dance
 Jan. 22 Disney Dance
 Feb. 12 Valentine Dance
 Feb. 26 Presidents Dance
 Mar. 12 Wizard of Oz

Mar. 26 Welcome Spring
 Apr. 9 Balloon Dance
 Apr. 23 Regular Dance
 May 14 Garden Party
 May 28 See You in September

Program: Mainstream
Location: American Legion Post 459
1015 Linwood Place
North Brunswick, NJ
Contacts: Ken Robinson 908-874-5830
Ginny Platania 732-249-0916
Betsy & Roy Gotta 732-249-2086
Dan & Kathy Koft 732-329-8507

Directions: Take Rt. 1 to the Georges Rd. New Brunswick Exit (from the north, keep to the right; from the south take the left turn jug-handle and then keep to the left). At the first intersection turn left, onto Cranbury Cross Rd. At the four-way stop, turn left onto Linwood Place. The hall is on the right just before the end of the road.

http://www.eclipse.net/~ksr/promenaders_new.html

KITTATINNY RANGERS – Andover, NJ MS/PL tip

2 & 4 Fri. Sept-June Long Pond School, Lime Crest Road

Nineteen Rangers honored outgoing President Donna Poyer with a dinner, gifts, and our sincere thank yous. Donna's positive outlook, her smiling face, her unfailing support no matter what was asked of her, and her enthusiasm are traits she always has. She radiates the friendliness and camaraderie that square dance clubs strive for. We're so glad she's ours. Two very capable Rangers are taking over the President's position. We now have Kay Davis and Leslie Schwenker to keep us moving forward and growing. Our club is truly blessed with good leadership.

We had a great summer pool party at Sally Mason's house. Thanks again, Sally. Many Rangers attended the Mini-Festival in Bridgewater and conventions in Colorado and Cambridge, MD. Also, they danced at the Sussex County Fair and demoed at the Merry Hill Senior Residence with Herb Conklin giving of his time to call for us.

Len Anfinson is teaching our Mainstream class this year. Our students are doing well and looking forward to the big Student Christmas Dance.

Our club celebrated our 25th Anniversary. Dorothy Jaworski did our beautiful decorations and Don Coy was our terrific caller. Our hall was full thanks to the 8 clubs who helped us celebrate.

Hope you all stayed healthy this season. That's a good reason to go Yellow Rock your partner right now.

Ad on page 8, 49

John & Ruth Seaman

201-764-7134

Break the tensions of daily living, or the tensions will break you.



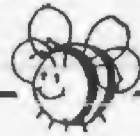

BEE SHARPS



PLUS Level Dances

Early Rounds 7:30 PM 2nd and 4th Friday Squares 8:00 - 10:30 PM

Date	Caller 	Cuer 	Theme
Jan 23, 98	Len Anfinen	Mary Pickett	Valatines Day Dance
Feb 13, 98	Jim Snyder	Steve Bradt	
Feb 27, 98	John Kaltenthaler	Mary Pickett	Chinese Auction 
Mar 13, 98	Len Anfinen	Steve Bradt	
Mar 27, 98	Dick Mazziotti	Mary Pickett	
Apr 24, 98	To Be Announced	Elaine Novak	

Soft Sole Shoes a Must

Dances held at:

United Methodist Church
Country Club & Van Holten Rd.
Bridgewater, NJ

For More Information Contact

Nancy & Victor	908-369-3418
Peggy & Steve	908-526-1309
Irma & John	908-722-3565
Linda & Mike	908-221-1579

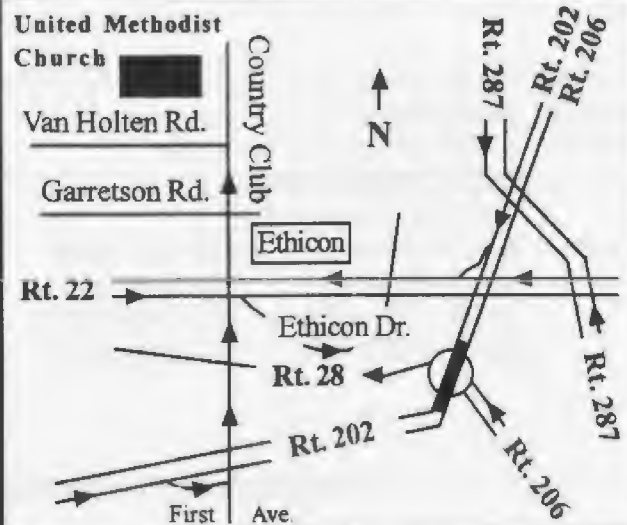

LAKELAND SQUARES -- Parsippany, NJ MS/PL tip

Every Tues. Sept-July Temple Beth Am, 879 S. Beverwyck Rd.

Everyone is proud of Kathy Keener, who was invited to Japan for 3 weeks in November as part of a group of 200 American teachers. She explains it as a thank you for the Fulbright scholars admitted to the U.S. over the years. A 5th grade teacher in Montville who actually speaks a little Japanese, Kathy is enthusiastic about the people she met, the schools she saw, and the places she visited. We'd love to be in her classroom this spring as she brings back a bit of Japan to some of New Jersey's schoolchildren.

We had a series of special dances this fall. Nick Martellacci set the tone for our Holiday Inn Dance by changing his outfit as he called to a variety of holiday songs. In October, we remembered Johnny Appleseed with apple desserts. Ahh, the aroma! Kathy Keener provided a biography of Johnny and a quiz on apple varieties. See how much you can learn at Lakeland? In November, we honored veterans and pilgrims, and in December, we dressed in red and green. Jean & Tony Stella decorated the hall to highlight the festivities; they always do that so well. We look forward to student dances in February and April. Students from all clubs are most welcome.

In May, we will be 25 years old. We plan a celebration. Watch for flyers.

Ad on page 36

Jim & Catherine Douglas

973-338-7787

Get your Poster Contest entry ready!

All entries must be received by the
NNJSDA 3rd VPs, Bill & Elsie Beebe
no later than Saturday, May 23. Rules on page 7.

MOUNTAIN SQUARES – Whippany, NJ

A-2

1 & 3 Wed. Sept-June

First Presbyterian Ch., 494 Route 10

Although the opportunities are limited for Advanced dancing, our Mountain Squares group can be found at a number of other clubs. Some of us enjoyed the Fun-for-All weekend (Plus) at Marshalls Creek, PA, with our own Joe & Debbie Landi, and Mary & Jack Pickett. Others traveled to Vermont for the Tumbling Leaves Festival for square dancing fun. And there is John Kaltenthaler and his wife, Freddie, who enjoy our relearning routines and filling up the squares on Monday nights at A classes in Rockaway. It's a great mix and a lively bunch!

So for whatever reason we dance, it's sociability par excellence! There is no need to worry about the office or the tomatoes not ripening; this is togetherness for the sake of square dancing. We play by the rules, hold hands and pray that the caller returns us to our partners. As you know from a bumper sticker, "Square dancing is a contact sport." We advertise the NJ state dance with our license plates and claim (as in Fairbanks, Alaska on a bumper sticker) that "Square dancers do it in groups of eight." Above all, in a hospital work-out room someone noticed a list of advice that one of the ways to maintain mental agility is to take dancing lessons, specifically square dancing. You knew that all along, didn't you?

We will change our program to A-1 for our January 21, February 4 & 18 dances. After our snowbirds return in March, we'll go back to A-2. Be sure to keep Wednesday, April 29 (5th Wed.) open for our A-1 Special.

Correction: Delegates Walt & Mildred Angerer's telephone is 973-226-5837.

Ad on page 34

Isabelle & Doug McCabe

973-226-3955

SUNDAY DANCES AT NOTTINGHAM

Feb. 1, 1998

Mike Callahan

District Dance

Plus Special

\$5/person members

\$6/person non-members

Mar. 1, 1998

Mark Franks

Freedom Valley Dancer

Benefit Dance

\$5/person early discount

\$6/person at-the-door

Ron & Ree Rumble

East Coast's Finest

Plus Squares 2x2 2:00-4:30

Pre-Rounds 1:30, A-2 tip: 4:30

Art & Loree Lindbloom 609-882-3929

Early-bird registration

Rich Delgado 609-530-0849

800-892-8828

Bucks-Trenton and Penn-Jersey Districts, FDVSRD

Laughter is the sun that drives winter from the human face.

Victor Hugo

SEE SAW



SQUARES

Old Stone Church Education Center
500 East Saddle River Road
Upper Saddle River, NJ 07458

Easy directions: GSP exit 172, west
on Grand Ave., north on East Saddle
River Road to Weiss Road.

PLUS DANCING ON THE THIRD SATURDAY

APD Plus Workshop at 8:00 p.m.

Advanced Tip at 10:30 p.m.

- Jan 17 **ROY LEBER - Chinese Auction**
Feb 21 **RANDY PAGE - Sweetheart Swing**
Mar 21 **DAN KOFT - Plant Sale**
May 16 **HOWARD RICHMAN - Mainstream Dance**
June 20 **JIM SNYDER**

Info: Lyn & Bob 201-327-927 Joan 914-353-2987 Raids: Carolyn 914-358-6043

RICHMOND DANCERS --Staten Island, NY

PL

2 & 4 Sat. Sept-June

All Saints Church, 2329 Victory Blvd.

We have a square dance class!!! Thanks to the hard work of Kathy & Charlie Porter, classes are held every Wednesday night. Now's the time to spread the word that we'll be starting another session next September. Why not call some former dancers that might be interested in join again.

We were all saddened this year by the loss of member Oscar Michaud. Oscar, with his long list of accomplishments and happy disposition, will be sorely missed. Richmond Dancers offers sincere sympathy to Brenda Meyerberg on the death of her mother and Jim Chukalas on the loss of his sister and brother-in-law.

Get well wishes are sent to loyal Richmond Dancers Bob & Doris Delaney and Jim Chukalas.

Did you know: Former Presidents Bridget & Dick Clancey are moving to NJ. We wish them luck and hope they'll still join us often. Current Presidents, Jim & Barbara Branigan, are planning their 50th Anniversary. Congratulations! The Motolas' welcomed their new grandson, Christopher, on October 8. The Delaneys had a family reunion at Rocking Horse Ranch in October with the whole clan.

Our dances have been great. If you haven't joined us for great callers, our traditionally great food table, and fun dancers, why not? Congratulations to all new graduates. Please feel welcome at our dances and have fun.

As we write this article Thanksgiving and all the Holidays are just around the corner. We all have a lot to be grateful for including square dancing and all the good friends we've made through it. We wish all of you a happy, healthy New Year filled with laughter, good friends and, of course, square dancing.

Ad on page 54

Grace & Lou Motola

718-447-1531

ROCKLAND PROMENADERS—Tappan, NY MS/PL tip
2nd Fridays Sept-June William O. Schaffer School, Lester Dr.

Rockland Promenaders is dancing on a new night, second Fridays, at a new location: the William O. Schaffer School in Tappan, NY, with new management. Our new officers are: Tom & Bonnie Silk, Presidents; Carl Luhrs, 1st VP; Bob Krieger, 2nd VP; Al & Ilse Dill, Treasurers; Gloria Kushner, Secretary; Chariss Smith, Corr. Secretary; Dick & Millie Adams, HV Delegates; Richard & Lucille Behrens, NNJSDA Delegates.

We have a great lineup of callers for the 1998 season, so come join us for fun Mainstream dancing including a hash MS tip and Plus tip to end the evening. We introduced the use of computer squares to our dances last year, and this program has been successful enough to continue. Our May dance will be a graduation ball for all new graduates. Two callers will mean continuous dancing with some fun tips thrown in to keep us on our toes and, of course, hash and Plus tips. So be sure to mark the date on your calendars. RP has two classes in full swing under the leadership of Burt Schain in Pearl River and Nanuet, NY.

Carl Luhrs & Chariss Smith became members of NJ's exhibition team, Red Rose, in January and performed at the NSDC in Orlando in June, and at the NNJSDA Mini-Festival in Bridgewater in November. Red Rose is putting out a plea for any dancers who might be interested in joining, as the group is on hold until they have a full complement of members.

We are pleased to announce our Rockland Promenaders couple of the year for Hudson Valley is Al & Ilse Dill. An honor much deserved for they have worked hard for the benefit of the club.

Ad on page 20

Chariss Smith

201-489-2498

VALLEY SQUARES

WOODRUFF SCHOOL

BRIARWOOD DRIVE, WEST - BERKELEY HEIGHTS, NJ

1st & 3rd Thursdays, 8-10:30 - Plus Program

Round Dance Workshop 7:30 - 8:00

February 5	Howard Richman	Steve Bradt	Valentine!
February 19	Ralph Stapenell	Steve Bradt	
March 5	Manny Amor	Steve Bradt	
March 19	Roy Leber	Steve Bradt	
April 2	Jim Snyder	Steve Bradt	
April 16 **	Dan Koft	Steve Bradt	
May 7	Don Coy	Steve Bradt	
May 21	Ed Foote	Steve Bradt	
June 4	Joe Landi	Steve Bradt	Ice Cream Social

** Hall to be announced

Info: Bud & Fran (908) 272-6316
 Barry & Norma (908) 464-1730
 Ted (908) 756-2552

info
732-249-2086

GOTTA DANCE

With Roy & Betsy Gotta

You
Gotta
Believe

1st 3rd & 5th Thursdays - BACtracks (A2 w/rounds)

Trinity Episcopal Church, Red Bank, NJ 8:00 pm

2nd & 4th Thursdays - Rutgers Promenaders (MSw/Rnds)

Amer. Legion, No. Brunswick, NJ 8:00 pm (with the Kofts)

Every Mon. - Get A Rounds (1st=Ph3/4 dancing only;

2nd, 3rd & 4th=Ph3/4 Teach & Dance)

Amer. Legion, No. Brunswick, NJ 8:00 pm (w/ Kathy Koft)

Occasional Tuesdays - C3A (Jan 27, Feb 24, Mar 31,

May 12 w/Ed Foote guest calling, Jun 9)

Amer. Legion, No. Brunswick, NJ 8:00 pm

Weekends at Cherry Ridge Campground

July 17-19 Roy & Betsy -A-2 w/Rounds

Aug 31 - Sept 3 w/ Mike Jacobs & Tom Miller

Plus & Adv

ROCKYTOPS of ROCKLAND -- Up. Saddle River, NJ PL/A-1 tip
1st Fri. Oct-June Old Stone Church., E. Saddle River Rd.

As the last leaves fall to the ground, its difficult to believe that summer and fall are behind us and we're fast approaching the holidays. I can almost hear the turkey gobble and the faint sound of jingle bells. The wonderful warm summer dances were well attended as were a number of weekend dances.

Our October and November dances were also well attended thanks to great callers and cueing by Nick & Carole Raspa in October and Karen Kushla in November. There was an excellent attendance at the Mini-Festival in Bridgewater and a terrific time was had by all.

Congratulations to: Maria & Roger Hoernlein on the birth of their grandson; Roz & Ron Samiljan on the marriage of their son, Jeff; and Esther & Willie Taffel on their 50th Anniversary. Jack & Jennifer Ting are also to be congratulated on their being selected as RockyTop couple of the year for the Hudson Valley Association. Exciting news from the Blottners. A new film, produced by their son, "The Dry Season," has some of our dances in it.

We love our new dance location in Upper Saddle River (same location as See Saws). There is more space, a better floor, and better lighting. Come dance with us. As always, delicious snacks and a warm, friendly atmosphere with great calling and cueing. We are 20 minutes from the intersection of the GSP and Rt. 80 and 10 minutes from either Tappen Zee Bridge or exit 172 of the GSP.

Ad on page 39

Maria & Roger Hoernlein

201-384-0334

Get Well Wishes. . .

Bob & Doris Delaney of Richmond Dancers

RUTGERS PROMENADERS -- North Brunswick, NJ MS
2 & 4 Thurs. Sept-May American Legion, 1015 Linwood Pl.

The Rutgers Promenaders started their 1997-1998 dance season with an enthusiastic crowd. We have had several spirited dances since. By the time you read this, we will have had our annual Toys for Kids dance in a new hall.

The Rutgers Promenaders are happy to have Betsy Gotta back, both as a caller and a dancer.

We are looking forward to some of the fun dances we have scheduled for the winter and spring and hope that you can join us.

Ad on page 29

Ken Robinson

908-874-5830

ROCKYTOPS



PLUS LEVEL DANCING WITH A-1 AFTERTIP

First Friday of Month — Rounds at 7:30pm — Squares from 8:00 to 10:30pm
Old Stone Church Ed. Ctr. — E. Saddle River Rd. at Weiss Rd. — Upper Saddle River, NJ

Friday, February 6	MIKE JACOBS	VA
Friday, March 6	MIKE CALLAHAN	NY
Friday, April 3	GLENN MATTHEW	PA
Friday, May 1	BOB PARIS	CT
Friday, June 5	TIM CRAWFORD	Canada

ROUNDS BY NICK AND CAROLE RASPA

For Further Information, Please Call:

Eileen & Larry
 Iris & Rich

(914) 362-1924
 (914) 620-1234

Roz & Ron
 Beverly & Marty

(201) 664-9356
 (201) 391-3592

SEE SAW SQUARES—Up.Saddle River, NJ MS/PL/CW
PL - 3 Sat. Sept-June Old Stone Ch. Ed. Ctr, 500 East Saddle River Rd.

See Saw members and guests enjoyed dancing to the calling of Howard Richman in September, Frank Riviccio in October, Roy Leber in November, and John Kaltenthaler in December. We raided Hix & Chix and Western Wheelers, and were raided by Hi Taw Twirlers.

Thanks to our generous members and guests, nonperishable food items brought to our November and December dances were delivered to People to People.

Carolyn Monahan was able to fit some square dancing into her recent trip to Germany.

See Saw offers Plus workshops at 8:00 p.m., Plus dancing at 8:30 p.m. and an Advanced tip at 10:30 p.m. on the third Saturday of each month. We welcome visitors, both couples and singles. We hope to see you on the dance floor soon.

Ad on page 32

Lyn & Bob Terry

201-327-9274

SPINNING WHEELS - Wayne, NJ MS/PL tip/CW

Every Mon. Sept-June Wayne Civic Center, Hamburg Trpk & Church Ln
2 & 4 Mon. July & Aug VFW, 6 Veterans Pl, Elmwood Park

Our club continues to grow with new members who join us on Monday nights where they know all will get a chance to dance. We have both Mainstream and Plus students this year and we continue to participate in community functions. We once again were the entertainment at Oakland's annual country theme dance, where in Bob Robinson's absence, George Haberberger, a club member who angels and sometimes calls at class, and Dolores Gesumaria, our President, introduced the AARP group to square dancing. Tuesday nights at the Senior Citizen Center in Oakland, Bob & Dolores teach a community dance program.

Though Bob does most of our calling, we've had some great guest callers. One of them, Marion Pearce, was calling the night of our Octoberfest. Most dancers arrived in very creative costumes. However, when the Devil walked in and crossed the floor, setting off the fire alarm, a "hot" time was had by all. Actually, we had to leave the hall and stand in the cold while the firemen investigated the real reason for the alarm. When we were permitted back in to dance, we had hot dogs, apple strudel, birch beer, and various other "Octoberish" kinds of things.

Some of the functions we are looking forward to are our Turkey Trot dance, Christmas dance, First Night in Oakland, several nursing home demos, raids, VFW holiday collection for the needy in the community, and to continue to dance through the holiday season and 1998 with all our friends.

Ad on page 11

Barbara McKenna

914-429-8848

M&M SQUARES

DANCE BY DEFINITION, ALL POSITION BASIC PROGRAM

All dancers welcome. Square dance attire is optional.

We dance :

Saturday, January 3

Saturday, April 4

Saturday, February 7

Saturday, May 2

Saturday, March 7

(new students welcome at all dances)

All Student and New Dancers WELCOME at ALL Dances !!!!

Pascack Reformed Church, Park Ridge, NJ
Dance from 7:30 to 10:00. Call Laurie or Dick Mazz-iotti for more information at (201)664-4482



For every minute you are angry you lose sixty seconds of happiness.
Ralph Waldo Emerson

HUNTERDON FLUTTERWHEELS

Echo Hill Park, Lilac Drive, Stanton Station, NJ

1998	Theme	Caller	Cuer
Jan. 2	New Years Dance	Len Anfinen	Peg Dockry
Jan. 16	Regular Dance	Wilson Hoff	Peg Dockry
Feb. 6	Valentines Dance & Pie Night	Wilson Hoff	Peg Dockry
Feb. 20	Regular Dance	Dick Mazziotti	Peg Dockry
Mar. 6	St Patricks Dance - Wear Green	Wilson Hoff	Peg Dockry
Mar. 20	Regular Dance	Bob Mitchell	Peg Dockry
Apr. 3	Covered Dish Dance	Wilson Hoff	Peg Dockry
Apr. 17	Regular Dance	Gerry & Chuck Hardy	Karen Kushla
May 1	Graduation Dance	Wilson Hoff	Peg Dockry
May 15	Ice Cream Social	Marion Pearce	Russ Booz

21st Annual Dinner Dance

Saturday, June 13, 1998, 6:00 PM, Stanton Grange, Stanton, NJ

Dan & Kathy Koft, Calling & Cueing

\$13.50 / person

Alternate MS & Plus Tips

1st & 3rd Fridays 8:00-10:15 PM

Early Rounds 7:30 PM

Soft sole Shoes - Please

For More Information

Stan & Sandy 908-995-7369

Art & Shirley 908-526-4960

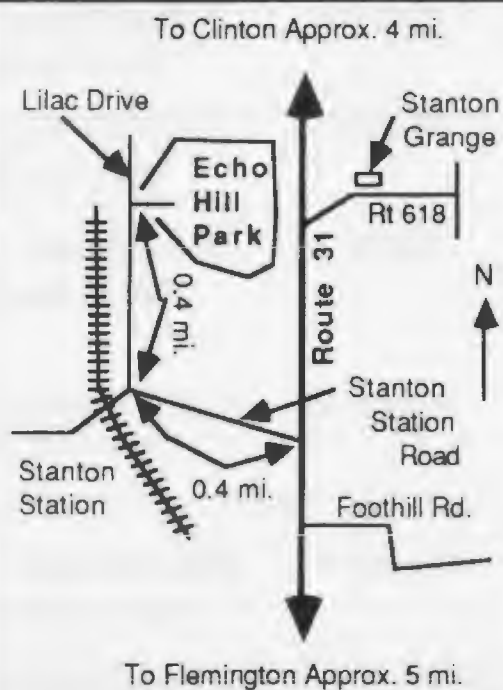

TENAKILL TWIRLERS – Cresskill, NJ

MS/PL tips

3rd Fri. Oct-May

Bryan School, Brookside Ave.

Our season started with the well-attended October dance. Howard Richman called and put us through some unusual moves. In the absence of Nick Raspa, round dancers enjoyed dancing to records furnished by Richard Gardener. Raids by Circle Eights and Rockland Promenaders filled the gym with the largest attendance in a long time, proving that Mainstream dancing is still very much alive.

We have an interesting array of callers scheduled for the coming dances, old favorites as well as newer callers. We look forward to seeing many of our friends in the New Year. Everybody is welcome.

Ad on page 10

Frank Poole

201-342-3375

CROSS TRAIL SQUARES



PLUS LEVEL with A-1 AFTERTIP

2nd & 4th Wednesdays: 8:00 - 10:30

* Square Dance Workshops: 7:30 - 8:00

** Round Dance Lessons: 7:30 - 8:00

Dancing at Lincoln School

Crane Street, Caldwell, N.J.

INFO: Testa (973) 226-9378

Sommer (973) 857-1370

RAID: Niosi (973) 482-5811

Date	Caller / Cuer	Theme
** Jan 28	Nick Martellacci Nick Raspa	Winter Blues Rounds
* Feb 11	Bob Mitchell Steve Bradt	Valentine Dance Rounds
** Feb 25	Randy Page Nick Raspa	President's Day Dance Rounds
* March 11	Bob Mitchell Mary Picket	St. Patrick's Day Dance Rounds
** March 25	Jim Snyder Nick Raspa	March Winds Rounds
March 29	<u>"30TH ANNIVERSARY DANCE"</u> Check our other ad in this issue of Grand Square for full details.	
* April 8	Bob Mitchell Dave Roberts	Spring Fling Rounds
April 22	John Kaltentahler Steve Bradt	Blossom Time Rounds
This dance to be held at the Caldwell United Methodist Church. 8 Academy Road, Caldwell, N.J. across the street from the Bloomfield Avenue TEXACO Station, Caldwell.		
May 13	Ron Kapnick	Graduation
May 27	To Be Announced Lois Bichier	Memorial Day Dance Line & Western
June 10	Bob Mitchell	Ice Cream Social
CASUAL ATTIRE for the Ice Cream Social. Soft shoes still a must.		

WESTERN WHEELERS -- Oradell, NJ **PL/A-1 tips**
2 & 4 Sat. Sept-June **Refrmd Ch of Oradell, 641 Church St (cor. Kinderkamack)**

Western Wheelers has once again started a full season of Plus dancing. Mickey & Margaret Hohmann are heading south to a new home. We wish them good luck and happiness as they depart from Bergen County.

Andy Musante and George Sutton are on the mend after surgery. They both hope to square up in the near future.

We were very saddened by the death of our Past President and very active member, Bob Wyman. Our deepest sympathy is extended to Gloria and her family. Bob will be missed for a long time to come.

Ad on page 27

Caroline Sutton

201-262-0616

SQUARE-VIEW

BY
MANNY AMOR



"THAT LAST TIP WAS SO FUNNY, I
LAUGHED MY HEAD OFF."

Y SQUARES -- Clark, NJ

MS

2 & 4 Fri. Sept-May

Carl Kumpf School, Mildred Terr.

Our square dance season opened with a successful Open House. We contacted churches and temples in the area in hopes of recruiting some younger dancers. Our class is small but enthusiastic. We welcomed several raiding clubs during the first half of season, while our dancers have been busy raiding also.

Our Halloween Dance brought out the witches and ghouls. Even the Grim Reaper showed up to dance. Thanksgiving was our theme for November. Everyone enjoyed the dieter's delight after the holiday, since we all ate so much the day before. We at Y Squares hope everyone had a wonderful holiday season and that 1998 is happy, healthy year for everyone. Don't forget to come visit us. We love having guests.

Ad on page 16

Jean Koenig

908-276-8049



By Rusty Ball

January, 1998

I am frequently asked where to get square dance skirt patterns, and my answer may dismay some: I make them. Wait, wait--if I tell you that, it's because it's something you can also do!!

I start with two sheets of newspaper, an old measuring tape, a pencil, and a pin. Place both sheets of the newspaper on top of each other, and work through two layers. Lay them down on a surface you can stick a pin into (or place a magazine under the corner of them.) Using your measuring tape as a compass, poke a hole in the end of the tape measure and push the tip of the pencil through; stick a pin into the tape at the 6" mark, and push the same pin in exactly at the corner of the newspaper (point "A"). Draw an arc across the corner 6" from point "A".

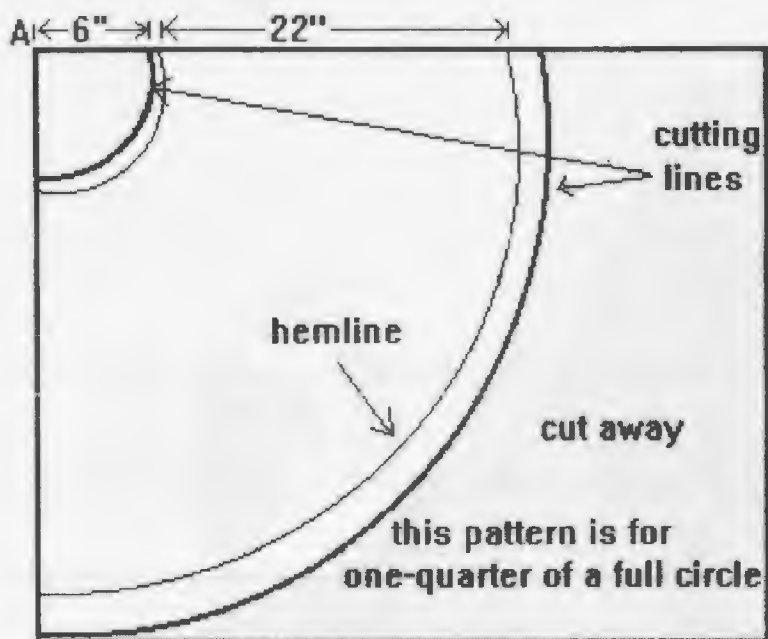

How long is your favorite petticoat? Measure its length from beneath the waistband to the hem. Add $\frac{1}{2}$ " and this is the length your finished skirt should be (22" in our diagram). Add 6" to this measure, move the pin to this mark of the tape (28"), and draw your second arc across the newspaper.

All that's left now is to add 1" to 2" to the hemline, depending on your hem finish, and then $\frac{5}{8}$ " to

the waist for the cutting line. Voila—you have a gore pattern for a quarter circle; cut it in half for an 8-gore skirt, or tape two together for a half-circle. If you are making 8 gores, however, add $\frac{5}{8}$ " on each side of the pattern piece for seam allowance, or the skirt will not be a flat circle.

Keep in mind when cutting the fabric that the grainline should go straight down the center of the gore from waist to hem—this way the bias will be along the seams and the hemline will not sag.

There is much more about skirts, both gored and tiered, that we could discuss if space permitted. Look for two (updated) Sewing Circle^{SQUARED} flyers this month in your delegate's stack of flyers from NNJSDA. See you in a square!

Remember, a SEWING CIRCLE is just a big zero until it is shared -- and ^{SQUARED}.

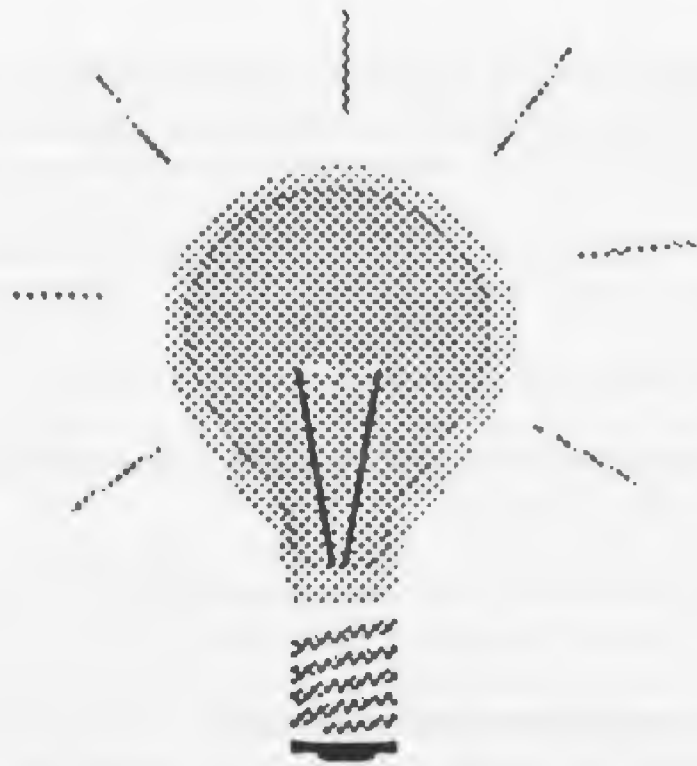

Calling Again

Mainstream & Plus



Stephen Forman

(201) 938-1824



NORTHERN NEW JERSEY ROUND DANCE LEADERS COUNCIL

We would be more than remiss, but downright negligent, were we not to put in writing the warm feelings shared by dancers and leaders who enjoyed the very successful Fall Festival of Rounds this past November. Kathy & Dan Koft's planning provided for a most pleasant dancing program for all. We commend Kathy & Dan for their fine choice of program, which proved so entertaining. There have been whispers heard by dancers that Julie Anne Koft reflects her parent's wonderful sense of rhythm and grace. Mom & Dad seem to be well "rounded" (pun intended) folks. For a Follow up good time, be sure to plan on attending the Spring Festival of Rounds scheduled for Sunday, March 29.

Signs of spring will soon be right around the corner and sadly, as of this writing, the NJ Convention has been canceled for 1998. The Square Dance Council of NJ has chosen to support the Docking Dance on August 1. for the 49th National Square Dance Convention to be held in Baltimore in June 2000. Please make it a point to support the Docking Dance.

The demise of the NJ Convention is directly attributable to the lack of support by us, the dance community. Yes, "US!" We all share in the lack of support to our leaders and dancing comrades who have been putting a great deal of work and effort to bring us, what has always been, a great, interesting, and entertaining convention through these many years. Perhaps some portion of the dance program did not suit you; perhaps another dancer offended you; perhaps the ceilings were too high; perhaps the ceilings were too low; perhaps the floor was too slippery, perhaps the floor was not smooth enough, perhaps..... Possibly some of us tend to forget that conventions are to be enjoyed as recreation as

Please turn to page 47



Beginner

Round Dance Class

Tuesday Nights, Starting April 14, 1998

8:00 - 10:00 pm

Instructor - **Roy Gotta** \$ 5.00 per person

**North Brunswick American Legion
1015 Linwood Place, North Brunswick, NJ**

Route 1 to New Brunswick/North Brunswick Exit. Go towards New Brunswick on Milltown Rd. At the first light, turn LEFT onto Old Georges Rd. At the next light, turn RIGHT onto Herman Rd. At the next light, turn LEFT onto Linwood Pl. Hall is three blocks on the right.

To Register - Call Roy @ 732-249-2086

Singles are welcome, but a partner is not guaranteed. Call, and I will try to match you with another single (if available).



AIX & CHIX

VFW HALL

6 Veterans Pl. Elmwood Pk
 (Behind Fire House; near Ball Field)
 796-9138

AIR CONDITIONED ALL SUMMER

ALL PLUS PROGRAM 3RD THURSDAY AND SPECIALS
 SQUARE DANCING FROM 8:00 TO 10:30 PM. ROUNDS AT 7:30 PM.

1998 DATE	CALLERS	SPECIAL EVENTS	CUERS
JAN. 22	SAM LOWE	SPECIAL	THE RASPAS
Feb. 19	John Kaltenthaler		The Raspas
March 19	Jim Snyder		The Raspas
April 18	Al Kaesler		The Raspas
APRIL 30	SHANE GREER	SPECIAL	THE RASPAS
May 21	Glen Matthew		The Raspas
JUNE 4	DEE DEE DOUGHERTY	SPECIAL	THE RASPAS
June 18	Randy Page		The Raspas
JULY 16	JOE FIORETTI	SPECIAL	THE RASPAS
AUG. 20	RANDY DOUGHERTY	SPECIAL	THE RASPAS
Sept. 17	Don Coy		The Raspas
Oct 15	Todd Feltegy		The Raspas
Nov. 18	Gerry & Chuck Hardy		The Raspas
Dec. 17	Jim Snyder	CHRISTMAS DANCE	The Raspas

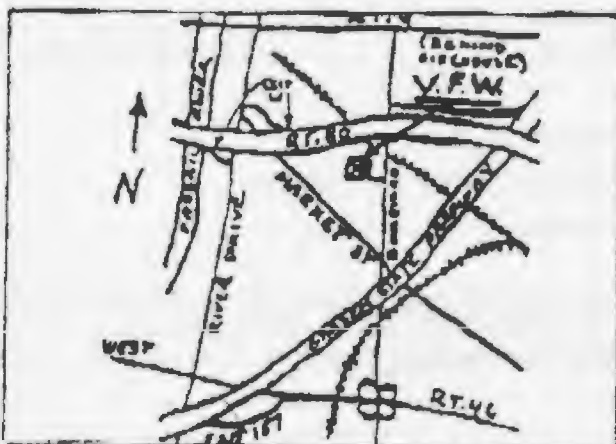

For further information call

John Huettemann (201) 438-0948

Dick Dexter (201) 529-3372

NNRDLC continued from page 46

opposed to competition, offering a wonderful opportunity that should be taken advantage of to share fellowship, a smile, a yellowrock, a tip, a meal, etc. all in a venture with our fellow dancers.

Although our population as a whole may have dwindled, quality—true quality—endures. We all need to reflect what a truly good and caring community we are by showing the Square Dance Council of NJ that we do support them—conceivably in a kind letter or phone call, an offer to help, a petition redressing support. Ideas, I'm sure, are plentiful through our dance community and we all need to step forward and do whatever it takes to ensure the continuing status and stability of this wonderful event. Once lost, it would take the parting the seas to bring it back to fruition. Remember, it won't work without your support and that's little to ask with a return that is ever so high.

Ad on page 67

Nick & Carole Raspa

201-896-1891

Round Dance Clubs . . .

CLOUD 9 – Parsippany, NJ

Wed - Ph.II-III+:7-8:30; Ph IV-IV+:8:30-10:15

Temple Beth Am,

Thurs - Ph III-IV: 7-8:30; Beginners: 8:30-10:15

879 S. Beverwyck Rd

The early Wednesday class is working on cha-cha basics, and the Phase IV+ group is concentrating on strengthening their knowledge of the foxtrot and the slow two-step. The early Thursday class is enthusiastically learning the quickstep and jive. A new beginners class started in October and they are keen to learn as they work on the basic rhythms. It's not too late to join in and double your pleasure when you go to a square dance.

The October dance party was enjoyed by all and please remember that we are always happy to welcome all round dancers. Watch for our flyers advertising future dance parties. Several Cloud 9 couples attended the NNJRDLG Fall Festival of Rounds at VFW in Elmwood Park in November and had a full afternoon of round dancing to many area cuers.

Cloud 9 classes are held at the same location as Lakeland Squares and although we usually dance every Wednesday and Thursday, please call if you do not have a copy of our schedule since classes are canceled when the Temple has activities.

Ed & Iris Zimany 973-267-1917

Mary & Jack Pickett 908-322-4148

ROCK "A" WAYS Advanced Workshop Club

REVIEW

PRACTICE

MAINTAIN

John Kaltenthaler - caller

**Monday nights - 7:30 to 10:00 - \$3.50 per person
casual dress**

**Rockaway Valley United Methodist Church Hall,
Valley Road, Boonton Township, NJ**

**ADVANCED dancers who want to learn and review A-2
join a friendly and relaxed group.**

For further information call Freddie (717) 646-2945

RAMAPO RHYTHMAIRES -- Rutherford, NJ

Mondays

Annunciation Ukrainian Church, Home Ave.

Because of a conflict of schedules, current classes and festivities will be temporarily interrupted. We promise to keep you advised of our status and be assured that we share in your disappointment. We will soon again connect and enjoy a fine, fun-filled program.

Nick & Carole Raspa

201-896-1891

DINGMAN DANCERS

Rich Murphy, Club Caller
2, 4 & 5 Tuesdays

Mainstream with Plus tip
7:30-9:30 pm

Delaware Valley Middle School Cafeteria, Routes 209/6, Milford, PA
No Dances in January and February!

Mar. 10	St Patrick's	May 12	Mad Hatters Ball (Prizes)
Mar. 24	Club Dance	May 26	Club Dance
Mar. 31	Cardinal Dance	Jun. 9	Club Dance
Apr. 14	Hobo Dollar Dance (Costumes)	Jun. 23	Dear Old Dad
Apr. 28	Club Dance	Jun. 30	Cardinal Dance-50s Attire
For information and directions:		John & Betty Rigo	717-775-0747
		Jim Dorcas	717-491-2084

Following is an article from a club that is not currently an NNSDA member. . .

M & M SQUARES – Park Ridge, NJ Interesting Basic
Pascack Reformed Church, Pascack Rd

1st Saturdays

It is a pleasure to call for the dancers at M & M. Just the Basic program, mind you, but boy do we have fun. The dancers yell at the caller, and occasionally nail him with a well-aimed shoe! The caller abuses the dancers by assuming they know the Basic moves. And we laugh a lot. At the November dance, Randy Page, who had been preparing for a month for the dance, put on quite a show. From all accounts, it was a fun, interesting, and challenging dance. Of course, we will never have him there again. The act is too hard to follow. But thanks, Randy, for showing what fun Basic can be.

Ad on page 40

Dick & Laurie Mazziotti

201-664-4482

Kittatinny Rangers

2 & 4 Fridays (7:30 PM)
 Alternating MS and Plus

Long Pond School
 Andover, NJ

Jan 23	Dan Koft
Feb 13	Len Anfinen
Feb 27	Bob Mitchell
Mar 13	Howard Richman
Mar 27	Len Anfinen "Student Dance"
Apr 10	NO DANCE
Apr 24	Ron Kapnick
May 8	Hank Lutcher
May 22	Len Anfinen (Pot Luck Dinner) (Casual Dress)

INFO: Kay Davis (201-697-7765)



PLUS COMMITTEE REVIEW

Larry Davenport, Chairman of the Plus Committee, is pleased to announce that the committee has completed the 1997 biennial review of the Plus Program.

The committee voted to drop: *Partner Tag*, *Remake the Thar*, and *Triple Scoot*. The Advanced Committee must now consider whether or not to add the calls dropped from the Plus Program to either the A-1 or A-2 Programs.

MASQUERADERS

1st, 3rd & 5th FRIDAYS

PLUS LEVEL

Prerounds: 7:30 pm

Squares: 8:00-10:30 pm

1998 DANCE SCHEDULE

		<u>CALLER</u>	<u>CUER</u>
January 2	NO DANCE		
January 16		Mark Franks*	Ron Rumble
January 30		Pete Diven	Pete Diven
February 6	VALENTINES	To Be Announced	Ron Rumble
February 20		Bob Gaunt	Ron Rumble
March 6		Al Kaesler	Tom Denniston
March 20	ST. PATRICK'S	Roy Leber*	Ron Rumble
April 3		Al Kaesler	Ron Rumble
April 17	PIE NIGHT	Jim Snyder	Lynn Sandstrom
May 1		Al Kaesler	Ron Rumble
May 15	ANNUAL MEETING/DINNER	Mark Franks*	Ron Rumble

* Star tip (Advanced or DBD)

AMERICAN CZECHOSLOVAK FARMERS' CLUB, Hankins Road, East Windsor, NJ
 (Just off Route 130. Four lights south of Route 571 or two lights north of the junction of Routes 130 and 33)
 INFORMATION: Please call 609-448-3981 or 609-448-4548

CALLERLAB QUARTERLY AND EMPHASIS SELECTIONS



Mainstream:	None
Plus:	Go Right/Left to a Wave (7/97)
	Fan the Boat (3/97)
Advanced:	Follow to a Diamond (1/98)
	Swing the Fractions (5/97)
Basic Emphasis	Run Family (9/97)
Mainstream Emphasis	Hinge Family (9/97)
Plus Emphasis:	Explode & (Anything) (11/97)

HELP WANTED HELP WANTED HELP WANTED

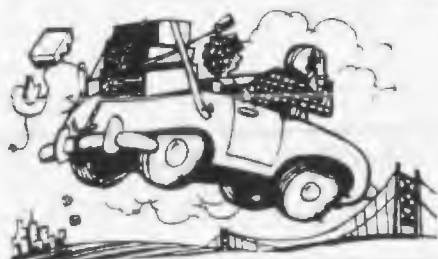

If you are driving to the NSDC in Charlotte, NC this year, please consider carrying the NNJSDA Display or boxes of **Grand Square**. Contact Bill & Elsie Beebe, 3rd VPs at 973-335-0127 or the Editors at 718-448-9761.

COUNTRY PROMENADERS

Stelton Community Center
 Plainfield Ave., Edison, NJ
 Two blocks from Route 27
 10 min from Tpk, GSP, 287



Hall Phone (732) 287-5678
 Jan & Louis (732) 577-9413
 Terry & George (908) 754-1425
 Inclement weather: call first

JOIN US FOR FUN DANCING & GREAT REFRESHMENTS

2nd & 4th SATURDAYS - NO BOOTS or HIGH-HEELED SHOES
 Early Rounds: Steve Bradt 7:30 - Plus Level Squares 8:00 - 10:30

- | | |
|----------------|--|
| Jan. 24, 1998 | DREW SCEARCE (VA) |
| ★ Feb. 14 | HOWARD RICHMAN - COOKIES for your COOKIE |
| Feb. 28 | JIM SNYDER |
| Mar. 14 | JOE LANDI - FUNNY SQUARES |
| Mar. 28 | ★ ★ ★ GARNIVALE ★ ★ ★ |
| | (see below) |
| Apr. 11 | No Dance - Happy Holidays! |
| Apr. 25 | JIM SNYDER GRADUATION : Mainstream w/ plus tips |
| May 9 | PROM NITE / DRESS UP PARTY |
| | PETE DIVEN (MD) - Squares and Rounds |

★ 1st Presbyterian Church of Cranford

ADVANCED OR D&D PLUS TIP AT END OF DANCE



GARNIVALE

J.R. SPARKS (IN)

SATURDAY, MARCH 28

COSTUMES WELCOME - LET'S PARTY!!



BEST GRIPES, 1997

by Dick Mazziotti, Caller/Teacher

Since beginning this column for *Grand Square*, dancers have started coming to me with their pet gripes, some in the hope that I'll mention their names, some in fear of same. In order to be fair, and avoid nasty run-ins with legal representatives, all gripes will theoretically come from A. Nonimoose, a Native American dancer.

Dear Dick: Why do dancers form set squares, and why do they sometimes stay in those squares all during the dance?

Dear A: This is a form of self-preservation practiced by dancers who are afraid they cannot make it on their own. Think of those set squares as small self-help groups.

Dear Dick: Why do some dancers shy away from dancing with me? When they see me coming across the floor, they scatter. What's wrong with me?

Dear A: Could be B.O. Note to A. and all other dancers, if you go to a dance, please put on deodorant. And for those who think they personally do not need that, have your nose checked—then shower before the dance and put on deodorant anyway. There is also the condition called fumigasious, brought on by having a drinkeepoo or two before the dance or indulging in a garlicky repast.

Dear Dick: Why do some callers not call loud enough for me to hear the calls when I'm in the back of the hall and talking?

Dear A: Callers always call loud enough. Sometimes a dancer's ears are out of proportion with his or her mouth, leading to the condition of mis-callitis. It is rare that callers cannot be heard by dancers who are not talking.

Dear Dick: Why do new dancers fail to continue with the activity?

Dear A: See all of the above. In this age of instant gratification through the World Wide Idiot Web, many adults are looking for diversion in their playtime. For some this takes the form of learning new skills like gardening, or square dancing. Then they go on to something else. We have failed to make the "grab" that those of us involved with the activity all feel.

There are other reasons. At a recent barn dance, in the middle of a tip, a dancer came running out, yanking a new recruit to put her in a new square, shouting loudly. "I can't do anything with them; I've got three in my square." THEM!!! THEM!!! That dancer stayed the evening. I would not have.

There are other reasons. Well-meaning diplomats take delight in telling new dancers all about the problems with square dancing. Duh! Wonder if that's an activity I'd like to invest more time? Note, we can fix two out of the above three if we want to.

Dear Dick: Why are you and other callers sometimes boring?

Dear A: Hmmmmm. How can I put this? Maybe we're trying to keep dancers dancing who are not proficient at the announced program. Put another way, I don't know many callers who cannot call a higher level than the dancers can dance. But I have a question for you:

Dear A: Why do dancers insist on going to more programs when they are not proficient at Basic or Mainstream? Huh?

Those were the main gripes for 1997.

CLUB AD MAKERS INFORMATION

Cover these dates in your ads for upcoming issues:

<u>Deadline</u>	<u>Issue</u>	<u>Dances Between:</u>
March 17	Grads/Summer	May 3 - Sept. 30
July 17	Fall	Sept. 1 - Jan. 31

32ND NATIONAL ADVANCED AND CHALLENGE SQUARE DANCE CONVENTION

JUNE 18, 19, 20, 1998

COMMONWEALTH CONVENTION CENTER
LOUISVILLE, KENTUCKY

STAFF CALLERS:

SAUNDRA BRYANT CHICAGO, IL	VIC CEDER LOS OLIVOS, CA	ED FOOTE PITTSBURGH, PA	ROSS HOWELL EUSTACE, TX
MIKE JACOBS HERNDON, VA	LEE KOPMAN WANTAGH, N.Y.	STEVE KOPMAN KNOXVILLE, TN	
DAVE LIGHTLY WALKEE, IOWA	ANNE UEBELACKER VANCOUVER, CAN	DAVE WILSON LARGO, FLA	

ASSOCIATE CALLERS: TODD FELLEGY, JOHN MARSHALL,
LLOYD (Sparky) SPARKS, JOHN STECKMAN, JOHN SYBALSKY

FIVE HALLS OF AIR CONDITIONED DANCING CONTINUOUSLY

ADVANCED (A-2), C-1, C-2, C-3A, C-3B (ALSO PART-TIME C-4 BASIC & C-4)

CONVENTION DANCING: THURSDAY AFTERNOON & THURSDAY NIGHT, JUNE 18
MORNING --- AFTERNOON --- EVENING DANCING ON FRIDAY & SATURDAY, JUNE 19 & 20

SPECIAL TRAIL-END DANCE WED. NITE, JUNE 17 ALL HALLS IN OPERATION CONDUCTED BY STAFF CALLERS	SPECIAL NON-STAFF CALLER DANCE THURS. MORNING, JUNE 18 ALL HALLS IN OPERATION
--	--

LOUISVILLE

- Numerous sightseeing attractions including the Kentucky Derby Museum, Churchill Downs racetrack tour, Louisville Slugger Museum & Bat Factory, Bell of Louisville cruise on the Ohio River, Muhammad Ali Museum, Kentucky Kingdom Thrill Park, and the Louisville Redbirds minor league baseball team.
- Air Travelers: Convention Center is 15 minute drive from Louisville Airport.
(Several hotels & motels within walking distance of Convention Center)
- Information on hotels, motels, campgrounds and sightseeing sent when you register.

ARRIVE EARLY - STAY AFTER CONVENTION - FOR A GREAT VACATION EXPERIENCE!

Check hall you will be dancing in the majority of the time:

A-2 C-1 C-2 C-3A C-3B C-4 C-4 BASIC

DANCE FEE: \$39/PERSON, DEPOSIT: \$10/PERSON, After May 15 - Send Full Payment

GS

Name _____

Address _____

MAIL TO:
ED & MARILYN FOOTE
140 McCANDLESS DRIVE
WEXFORD, PA 15090

THE NEW DANCE CLASSES

by Dick Mazziotti, Caller/Teacher

While our area is not exactly rolling in a wealth of new dancers, basic classes have been running at several Mainstream and at least two Plus clubs that I know of. It remains a strong disappointment to see the lack of support club members give their own classes. And no less a disappointment to see the lack of support Plus and Advanced clubs give to the new dancers. Put another way, if YOU are not helping out at one of the Mainstream classes occasionally, YOU are not supporting this activity.

The retention of new dancers is so important for the continuation of our activity that it cannot be glossed over by writing "nice" or "funny" columns or articles. Considering that the lack of new dancers has been the major factor in the decline of the number of clubs, in the demise of Association student dances, in the poor attendance at student dances, we should be treating them like gold. Instead, we ignore them, hoping that this year, like last year, there will be enough dedicated people "like" that sort of thing, dancing with them, and enough callers teaching them. Then the really good ones can be recruited into the Plus and Advanced program.

One club this year has gone begging to find callers to teach their class. At least three other clubs that I know of have classes which are composed of two-three squares, mostly of new dancers, instead of the 5 or 6 squares, with just two or three new dancers per square, that it should be. Then the callers could spend the evening teaching and having fun with the dancers rather than continually having to straighten out confused squares.

We NEED all you good dancers to come to the student dances. We NEED all

Please turn to page 58



RICHMOND DANCERS

2 & 4 Saturdays
Plus Squares 8:00-10:30 PM

1998			
Jan.	24	Nick Martellacci	
Feb.	14	Manny Amor	Mar. 28 Besty & Roy Gotta
		<i>Valentine's Dance</i>	Apr. 25 Frank Riviccio
Feb.	28	Dan Koft	May 9 Gary Potts
Mar.	14	Dick Mazziotti	May 23 Manny Amor
		<i>St. Patrick's Dance</i>	June 20 Jim & Deanne Emory

All Saints Episcopal Church, 2329 Victory Blvd., Staten Island, NY
 From NJ: Take Victory Blvd. Exit from the SI Expwy. Make left on Victory to Crystal Ave. Make left on Crystal. Church lot is the 2nd right.
 From Brooklyn: Take the Bradley Ave. Exit from the SI Expwy. Make right onto Bradley. Make left at Victory Blvd. to Crystal Ave. Make right on Crystal. Church lot is 2nd right.

Information: Branigans - 718-448-2154; Porters 718-448-9761
Special drawing for a free admission for visitors who come across a bridge.



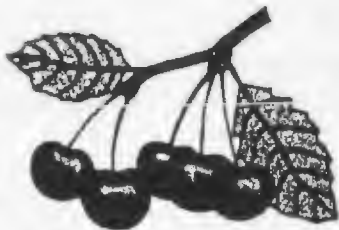

ACCOMMODATIONS

Campsites

Shaded, wooded and field - all with water and electric, some with sewer.

Housekeeping cottages

1, 2 & 3 bedrooms, kitchen and bathroom. Pots, pans, dishes, silverware, blankets and pillows provided. You bring linens or they can be rented at \$2.00 per set.

CHEERRY RIDGE

Lodgings

Rooms with private bath
Rooms with semi-private baths
Kitchens available with stove, refrigerator, pots, pans, dishes and silverware.
Pillows, blankets, linens and towels are provided.



NO GREY WATER TO RUN ON GROUND
PA STATE LAW

FACILITIES

Two dance halls with wooden floors available for weddings, reunions, etc.

- * Private lake, sheltered, spring-fed and state approved for swimming. Shallow area for children.
- * Private boats permitted (electric motors only)
- * Bathrooms with flush toilets and hot showers.
- * Snack Shack
- * Free Dumping Stations
- * Coin operated laundry
- * Playground equipment
- * Area for outdoor sports
- * Pets on leash permitted NO Animals in Rooms.
- * Bicycle riding during daylight hours only

Cherry Ridge Campsites & Lodging, Inc.

RR 2 Box 500
Honesdale, PA 18431
717-488-6654



Family Owned & Operated

Your hosts, Al and Cindy Waiter, along with Al Jr., Jason & Kimberly look forward to welcoming you to our campground this season!



Square, Round and Country Western Line Dance weekend programs held during the season. Call or write for information.

Not responsible for typographical errors.

CHERRY RIDGE
Campsites and Lodgings
1998
DANCING SCHEDULE

DATE	START	LEVEL	RD	CALLER(S)	\$\$
MAY 8-9-10	F	C-3		CLARK BAKER & JOHN SYBALSKY	\$30
MAY 8-9-10	F	PLUS & RDS		PAT PUSH & PEG THOMPSON	\$24
MAY 15-16-17	F	C-2	X	TODD FELLEGY	\$28
MAY 22-23-24-25	F	PLS & A-2	X	ROY LEBER & MARK FRANKS	\$30
MAY 29-30-31	F	C-1		BILL HARRISON	\$24
MAY 29-30-31	F	WEST & LINE		KATHY HALLIWELL	\$28
JUN 5-6-7	F	C-2		ROY LEBER	\$28
JUN 5-6-7	F	RDS 5 & 6		RON & REE RUMBLE	\$28
JUN 12-13-14	F	C-1 & 2	X	TIM SCHOLL & TODD FELLEGY	\$28
JUN 19-20-21	F	PLS & A-2		RANDY PAGE & NORM POISSON	\$28
JUN 26-27-28	F	C-3A		ROSS HOWELL	\$28
JUN 26-27-28	F	WEST & LINE		JANE MARIE DORSEY	\$28
JUL 2-3-4-5	THU	A-2	X	MIKE JACOBS & JOHN STECKMAN	\$30
JUL 10-11-12	F	C-2		RON LIBBY	\$28
JUL 10-11-12	F	RDS 4-5-6		JO YAKIMOWSKI	\$28
JUL 12-13-14	SUN	C-2	X	ANN UEBELACKER	\$28
JUL 17-18-19	F	C-3A		DAVE HODSON	\$28
JUL 17-18-19	F	A-2 & RDS		ROY & BETSY GOTTA	\$24
JUL 19-20-21	SUN	C-3A		MIKE JACOBS	\$28
JUL 22-23-24	WED	C-3A		TODD FELLEGY	\$28
JUL 24-25-26	F	C-3A		SANDRA BRYANT	\$28
JUL 24-25-26	F	C-1		KEITH STEVENS	\$24
JUL 31-AUG 1-2	F	INTRO C-3A	X	MIKE JACOBS	\$28
JUL 31-AUG 1-2	F	A-2	X	TOM MILLER	\$24
AUG 7-8-9	F	C-1	X	KEVIN VAN VLIET	\$24
AUG 7-8-9	F	WEST & LINE		JANE MARIE & SKIP DORSEY	\$28
AUG 14-15-16	F	C-2	X	JOHN MARSHALL	\$28
AUG 21-22-23	F	PLUS	X	JOHNNY PRESTON	\$24
AUG 21-22-23	F	C-2		NORM POISSON	\$28
AUG 28-29-30	F	C-3		ETT McATEE & LINDA KENDALL	\$30
AUG 28-29-30	F	RDS 2-3-4		MARY & JACK PICKETT	\$25

CHERRY RIDGE
1998
DANCING SCHEDULE

DATE	START	LEVEL	RD	CALLER(S)	\$\$
SEP 4-5-6-7	F	PLUS	with	MIKE JACOBS & BETTSY GOTTA & TOM MILLER	\$30
		Adv. Wrkshop		RDS W/ ROY GOTTA & MARY PICKETT	
SEP 11-12-13	F	C-1	X	MIKE JACOBS	\$24
SEP 18-19-20	F	C-3A		DAVE HODSON	\$28
SEP 18-19-20	F	A-2		KEVIN VAN VLIET	\$24
SEP 20-21-22	SUN	C-3A		BARRY CLASPER	\$28
SEP 23-24-25	WED	C-3A		ETT McATEE & LINDA KENDALL	\$28
SEP 25-26-27	F	C-3A		BEN RUBRIGHT & MIKE JACOBS	\$30

CHERRY RIDGE CAMPSITES & LODGINGS -- R.R. BOX 500 -- HONESDALE, PA 18431
(tel) 717-488-6654

NOTES

Cherry Ridge has two dance halls, both with wooden floors.

An "X" appearing in the column labeled "RD" indicates that the resident cuer – Mary & Jack Pickett – will be cueing rounds between Square Dance tips. They will also provide a half hour of rounds prior to the Friday and Saturday night evening dances plus a teaching session Saturday afternoon.

A typical week-end dance schedule consists of:

- Friday night:
 - > early rounds from 8:30 to 9:00 PM
 - > feature square dance from 9:00 to 11:30 PM with star tips afterwards
- Saturday:
 - > square dance work shop from 10:00 AM to Noon
 - > rounds teaching session (where applicable) from 1:00 to 2:30 PM
 - > square dance work shop from 2:30 to 4:00 PM
 - > early rounds from 8:00 to 8:30 PM
 - > feature square dance from 8:30 to 11:00 PM with star tips afterwards
- Sunday: feature square dance from 10:00 AM to Noon

For the May 22 through 25 week-end (Memorial Day) both halls will be used, with one for Plus level and the other for A-2 level square dancing.

For the June 19 through 21 and Sep 4 through 7 week-ends the floor level is PLUS, but there will be A-2 work shops during the Saturday morning and afternoon work shop sessions.

For the June 26 through 28 week-end the floor level is C-3A while teaching C-3 concepts.



"NOTHING COULD BE FINER THAN TO BE IN CAROLINA"

The 47th NSDC will take place under one roof in the Charlotte Convention Center. This 800,000 plus square foot facility allows all dancing to take place under one roof! That means that if you so desire, you can arrive in the morning,

dance, participate in various convention activities, eat, relax, and leave for your accommodations without having to leave the building.

Bus Passes: Public parking downtown is very limited, not close to the Convention Center, and expensive. Be sure to buy your bus passes. Convention buses will run between convention hotels and motels, as well at park and ride locations for RVers and other commuters.

Youth Hall: There will be a Youth Hall on the upper level on the Convention Center with a wood floor and 5,000 square feet of dance space. Special events will start on Wednesday evening with a Youth Trail End Dance and continue all week long with special after parties and activities.

Campgrounds: Commercial campgrounds around the Charlotte area are already filling up during Convention week. There will be plenty of space for dry camping at the Charlotte Motor Speedway. Reserving space is easy. Just fill out your registration form stating your camping desires.

Golf Tournament: On Wed., June 24 at Regent Park Golf Club, Fort Mill, SC, there will be four-person teams playing a "Scramble." The course is a par 72 carved from naturally rolling, wooded terrain, with fairways lined by towering oaks and pines, and beautifully accented with redbuds, dogwoods, and azaleas. Info: Golf Tournament Registration, PO Box 562814, Charlotte, NC 28256-2814.

Concert: Rock 'N Roll with Sha Na Na at the 47th NSDC on Wed., June 24. Admission is \$10 per person.

<p>Scottish Rite Masonic Temple 99 Two Bridges Road Lincoln Park, NJ 201-694-2233</p>	<p style="text-align: right;">NNJSDA SPECIAL DANCES: Jan. 31 and May 30</p> <p>From Rte. 80 West, take Exit 52 and follow signs toward Lincoln Park NOTE: There is NO exit for Two Bridges Rd. from Rte. 80 East; take Rte. 46</p> <p>From Rte 46 East or West: take the Lincoln Park/Fairfield Exit, and follow signs toward Lincoln Park</p>
<div style="display: flex; justify-content: space-around; align-items: center;"> <div style="border: 1px solid black; padding: 2px; text-align: center;">Scottish Rite Masonic Temple</div> <div style="border: 1px solid black; padding: 2px; text-align: center;">Meadows Golf Club</div> </div> <p style="text-align: center;">0.5 miles</p>	
<p>Two Bridges Rd</p> <hr style="border: 1px solid black;"/>	
<p>Route 80</p> <hr style="border: 1px solid black;"/>	<p>Route 23</p> <hr style="border: 1px solid black;"/>
<p>Route 46</p> <hr style="border: 1px solid black;"/>	<p>Route 80</p> <hr style="border: 1px solid black;"/>
<p>Exit 52</p>	<p>Route 46</p> <hr style="border: 1px solid black;"/>
	<div style="border: 1px solid black; padding: 2px; text-align: center;">Willowbrook Mall</div>
	<p>0.3 miles NOT TO SCALE</p>
	<p style="writing-mode: vertical-rl; transform: rotate(180deg);">Garden State Parkway</p>
	<p>↑ N</p>

Mazziotti Column continued from page 54

you good dancers to come to the classes. We don't NEED more dancers to go to hot-dog weekend (although these too are declining in a major way). So please, don't ever ask me how "my" class is coming. You are liable to get a rude answer. Instead, come once or twice and see how it's going. Come and meet some of the new dancers. Come and dance with them.

Cheerfulness is what greases the axles of the world.
Don't go through life creaking.

LETTERS TO THE EDITORS...

Many square dancers cannot realize how serious our problems are. Our numbers are constantly shrinking, and there are two basic reasons:

1. Attrition is going on as it always has: (a) people move to other places as they get older; (b) people die; (c) people develop physical problems that slow their ability to keep up with the current pace.

2. Classes are few and small. Young people are not available. They work hard and do not have time to attend weekly classes. This occurs today in many other endeavors, and with a few exceptions, the new dancers are older people.

The new graduates (senior citizens) and the veteran dancers (senior citizens) are having a tough time at the current pace. We are 20-year veteran square dancers, and are typical of many others who are having problems. We realize there are some who prefer to dance at a fast and intricate pace. Just a short while back we did too. Square dancing survival will require that we dance at a slower level to keep new graduates and the old veterans.

We suggest that there be shorter patters, or else eliminate them altogether and have two singing calls. This will cut down on the physical activity and make square dancing more fun. There are thousands of good old songs that are never heard at a square dance. Let's cut out the mediocre songs and have great songs. This could be a way to save square dancing and revive the wonderful songs that are so precious.

Maurie & Taras Berlinrut, Y Squares & Valley Squares

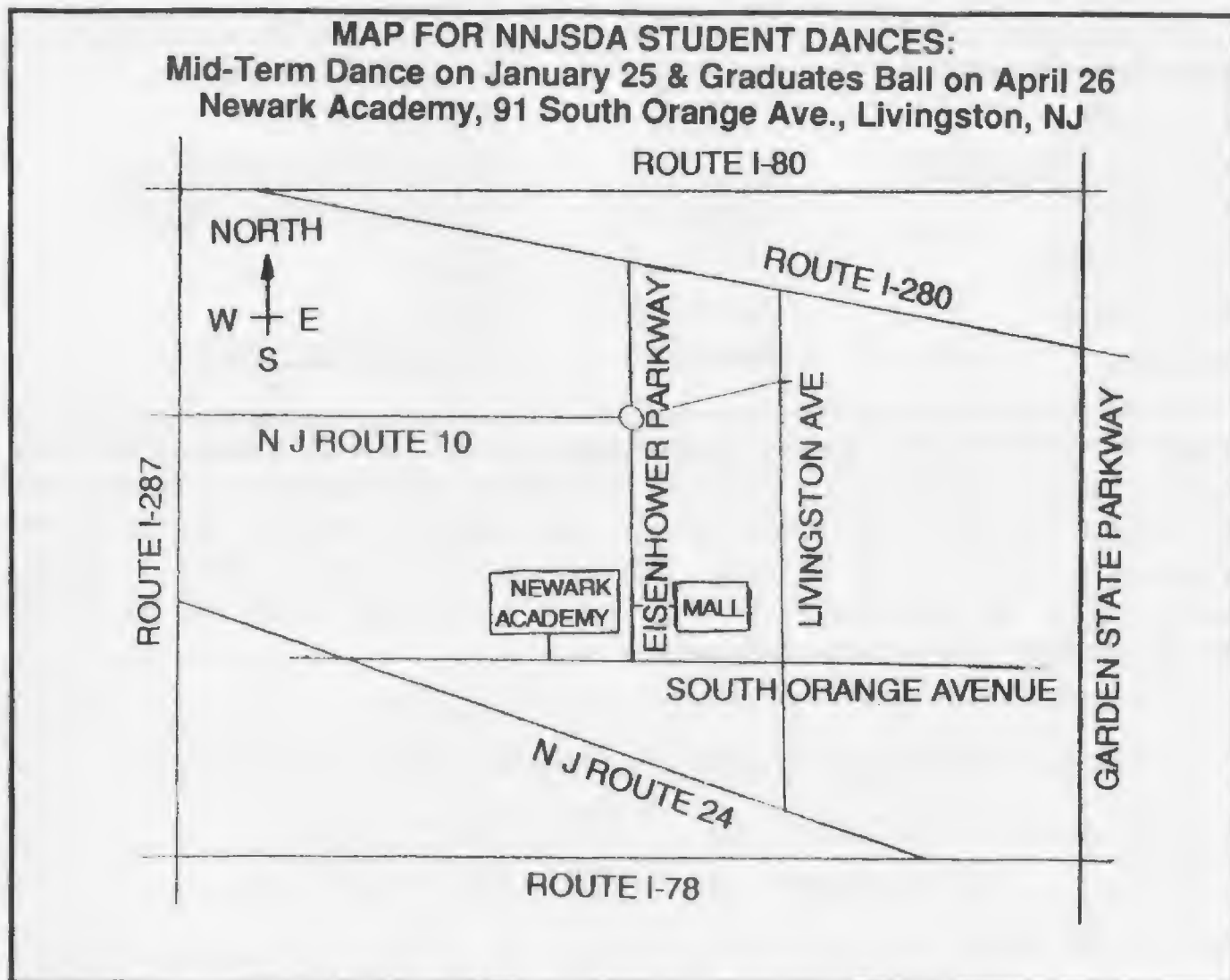

INVESTIGATE '98 AT 37th DELAWARE VALLEY CONVENTION

Sept 10-12, 1998 at the Cherry Hill Hilton, Cherry Hill, NJ

Registration info: Casey Bradshaw 302-369-6050

Email: jcbadshaw@aol.com

AL e MO Squares

*Our Lady of Grace R.C. Church
Avenue W and East Fourth Street*

Sundays at 7:30 – 10:00 pm

<u>CALLER</u>	<u>DATE</u>	<u>THEME</u>
<u>DAVID SCHLYER</u>	<u>JAN 11</u>	<u>INTERNATIONAL NIGHT</u>
<u>JIM EMORY</u>	<u>JAN 25</u>	<u>BENEFIT DANCE</u>
<u>FRANK RIVICCIO</u>	<u>FEB 8</u>	<u>VALENTINE'S DAY</u>
<u>ANDY WOERNER</u>	<u>FEB 22</u>	<u>PRESIDENT'S DAY</u>
<u>MIKE CALLAHAN</u>	<u>MAR 8</u>	<u>A NATIONAL CALLER</u>
<u>MARION PEARCE</u>	<u>MAR 22</u>	<u>PUZZLE DANCE</u>
<u>DON COY</u>	<u>APR 26</u>	<u>GRADUATION</u>
<u>GORDON HARPER</u>	<u>MAY 24</u>	<u>RED, WHITE & BLUE</u>
<u>DON COY</u>	<u>JUNE 14</u>	<u>FAMILY DAY PICNIC</u>
<u>Gerry Hardy</u>	<u>JULY 22</u>	<u>TBA</u>
<u>Betsy Gotta</u>	<u>JULY 29</u>	<u>TBA</u>
<u>Don Coy</u>	<u>SEPT 13</u>	<u>WELCOME BACK</u>

(Directions: Belt Parkway eastbound exit at Ocean Parkway, North, make right onto Ocean Parkway, proceed to Avenue W and make a left turn. Go to E.3rd. Street, make a right into parking lot behind Church. For those dancers who use the streets, get to Ocean Parkway and turn at Avenue W, going west to E,4th. or E.3rd. Streets.

For further information, please call:
Vincent at 718 615-1507
Caroline at 718 745-3793

ADMISSION \$4.00 per person

MAINSTREAM W/PLUS TIPS

Refreshment Table

FINAL TIP A/2

THE BEST CLUB WITH THE BEST CALLERS

Dance Calendar

Listing of dances, weekends and workshops prepared from ads
appearing **IN THIS ISSUE**. Please see ad for details.

Abbr: A=Advanced; Alt=Alternate; C=Challenge; CW=Country & Western; MS=Mainstream;
PL=Plus; RD=Rounds; TBA=To Be Announced; WS=Workshop; *See caller/cuer ad for details.

Student and Graduation Dances are italicized.

Date	Club	Caller/Cuer/Leader	Place	Program
January:				
20	Hi Taw Twirlers	Snyder/Raspa	New Milford, NJ	PL/RD/A-2 tip
	Lakeland Sqs.	Mitchell/Johnson	Parsippany, NJ	MS/PL tip/CW
21	Belles & Beaux	Mazziotti	Glen Rock, NJ	MS/PL tips
	Mountain Sqs.	Landi	Whippany, NJ	A-1
22	Hix & Chix	Lowe/Raspa	Elmwood Park, NJ	PL/RD
	Rutgers Promenaders	Gottas or Kofts	N. Brunswick, NJ	MS/RD
23	Bee Sharps	Anfinsen/Pickett	Bridgewater, NJ	PL/RD
	Circle Eights	Richman	Haworth, NJ	MS/PL tip
	Kittatinny Rangers	Koft	Andover, NJ	Alt. MS & PL
	Y Squares	Mazziotti/Kushla	Clark, NJ	MS/RD
24	Country Promenaders	Scarce/Bradt	Edison, NJ	PL/RD
	Richmond Dancers	Martellacci	Staten Island, NY	PL
	Western Wheelers	Leber/Raspa	Oradell, NJ	PL/RD/A tips
25	Al'e'Mo Sqs.	Emory	Brooklyn, NY	MS/PL tips
	Harmony Dancers	Rumble	Cranford, NJ	RD
	Motiv8ors	Lowe/Raspa	Paramus, NJ	A-2/RD/C-1 tip
	NNJSDA Mid-Term	Many callers	Livingston, NJ	Student
26	Spinning Wheels	Robinson/Gesumaria	Wayne, NJ	MS/PL tip/CW
27	Lakeland Sqs.	Koft/Pickett	Parsippany, NJ	MS/PL tip/RD
28	Cross Trail Sqs.	Martellacci/Raspa	Caldwell, NJ	PL/RD/A-1 tip
31	NNJSDA Special Dance	Callahan/Kushla	Lincoln Park, NJ	PL/RD
February:				
1	F.A.D. Sqs.	Hardy	Paramus, NJ	Student
	Kings Sqs.	Mazziotti	Brooklyn, NY	PL
	Motiv8ors	Jacobs/Raspa	Paramus, NJ	A-2/RD/C-1 tip
2	Spinning Wheels	Robinson/Gesumaria	Wayne, NJ	MS/PL tip/CW
3	Hi Taw Twirlers	Richman/Raspa	New Milford, NJ	PL/RD/A-2 tip
	Lakeland Sqs.	Mitchell	Parsippany, NJ	MS/PL tip
4	Belles & Beaux	Richman	Glen Rock, NJ	MS/PL tips
	Mountain Sqs.	Landi	Whippany, NJ	A-1
5	Valley Sqs.	Richman/Bradt	Berkeley Heights, NJ	PL/RD
	Warren Wheelers	Kerns	Port Murray, NJ	Alt MS & PL
6	Hunterdon Flutterwhls.	Hoff/Dockry	Stanton Station, NJ	Alt MS & PL/RD
	Ironia Reelers	Landi/Pickett	Randolph, NJ	PL/RD
	Ocean Waves	Koft	Staten Island, NY	MS/PL tips
	RockyTops	Jacobs/Raspa	Up. Saddle River, NJ	PL/A-1 tip/RD
7	Harmony Dancers	Kaltenthaler/Bradt	Mountainside, NJ	PL/RD/A tips
8	Al'e'Mo Sqs.	Riviccio	Brooklyn, NY	MS/PL tips
	<i>Belles & Beaux</i>	<i>Mazziotti/Page</i>	<i>Glen Rock, NJ</i>	<i>Student</i>
9	Spinning Wheels	Mitchell/Gesumaria	Wayne, NJ	MS/PL tip/CW
10	Lakeland Sqs.	Mazziotti/Johnson	Parsippany, NJ	Student
11	Cross Trail Sqs.	Mitchell/Bradt	Caldwell, NJ	PL/RD/A-1 tip
12	Rutgers Promenaders	Gottas or Kofts	N. Brunswick, NJ	MS/RD
13	Bee Sharps	Snyder/Bradt	Bridgewater, NJ	PL/RD
	Kittatinny Rangers	Anfinsen	Andover, NJ	Alt. MS & PL
	Rockland Promenaders	Stapenell	Tappan, NY	MS
	Y Squares	Koft/Kushla	Clark, NJ	MS/R
14	Country Promenaders	Richman/Bradt	Cranford, NJ	PL/RD
	Richmond Dancers	Amor	Staten Island, NY	PL
	Western Wheelers	Page/Raspa	Oradell, NJ	PL/RD/A tips
15	F.A.D. Sqs.	Martellacci	Paramus, NJ	MS/PL tip/CW
	Kings Sqs.	Koft	Brooklyn, NY	PL
	Motiv8ors	Jedlicka/Raspa	Paramus, NJ	A-2/RD/C-1 tip
17	Lakeland Sqs.	Conklin/Johnson	Parsippany, NJ	MS/PL tip/CW
18	Mountain Sqs.	Landi	Whippany, NJ	A-1
19	Hix & Chix	Kaltenthaler/Raspa	Elmwood Park, NJ	PL/RD
	Valley Sqs.	Stapenell/Bradt	Berkeley Heights, NJ	PL/RD

Continued on page 62

February contd:

19	contd Warren Wheelers	Pasvolsky	Port Murray, NJ	Alt MS & PL
20	Hunterdon Flutterwhls.	Mazziotti/Dockry	Stanton Station, NJ	Alt MS & PL/RD
	Ironia Reelers	Page/Pickett	Randolph, NJ	PL/RD
	Ocean Waves	Richman	Staten Island, NY	MS/PL tips
	Tenakill Twirlers	Koft	Cresskill, NJ	MS/RL tip
21	Harmony Dancers	TBA/McGee	Mountainside, NJ	PL/RD
	See Saw Sqs.	Page	Up. Saddle River, NJ	PL/A tip
22	Al'e'Mo Sqs.	Woerner	Brooklyn, NY	MS/PL tips
23	Spinning Wheels	Pearce/Gesumaria	Wayne, NJ	MS/PL tip/CW
24	Hi Taw Twirlers	Martellacci/Raspa	New Milford, NJ	PL/RD/A-2 tip
	Lakeland Sqs.	Pasvolsky/Pickett	Parsippany, NJ	MS/PL tip/RD
25	Cross Trail Sqs.	Page/Raspa	Caldwell, NJ	PL/RD/A-1 tip
26	Rutgers Promenaders	Gottas or Kofts	N. Brunswick, NJ	MS/RD
27	Bee Sharps	Kaltenthaler/Pickett	Bridgewater, NJ	PL/RD
	Circle Eights	Mazziotti	Haworth, NJ	MS/PL tip
	Kittatinny Rangers	Mitchell	Andover, NJ	Alt. MS & PL
	Y Squares	Landi/Kushla	Clark, NJ	MS/R
28	Country Promenaders	Snyder/Bradt	Edison, NJ	PL/RD
	Richmond Dancers	Koft	Staten Island, NY	PL
	Western Wheelers	Mazziotti/Raspa	Oradell, NJ	PL/RD/A tips

March:

1	F.A.D. Sqs.	Kapnick/Edison	Paramus, NJ	Student
	Kings Sqs.	Coy	Brooklyn, NY	PL
	Motiv8ors	Fellegly/Raspa	Paramus, NJ	A-2/RD/C-1 tip
2	Spinning Wheels	Robinson/Gesumaria	Wayne, NJ	MS/PL tip/CW
3	Hi Taw Twirlers	Kaltenthaler/Raspa	New Milford, NJ	PL/RD/A-2 tip
	Lakeland Sqs.	Mitchell/Pickett	Parsippany, NJ	MS/PL tip/RD
4	Belles & Beaux	Corey	Glen Rock, NJ	MS/PL tips
	Mountain Sqs.	Landi	Whippany, NJ	A-2
5	Valley Sqs.	Amor/Bradt	Berkeley Heights, NJ	PL/RD
	Warren Wheelers	Mazziotti	Port Murray, NJ	Alt MS & PL
6	Hunterdon Flutterwhls.	Hoff/Dockry	Stanton Station, NJ	Alt MS & PL/RD
	Ironia Reelers	Schain/Pickett	Randolph, NJ	PL/RD
	Ocean Waves	Pearce	Staten Island, NY	MS/PL tips
	RockyTops	Callahan/Raspa	Up. Saddle River, NJ	PL/A-1 tip/RD
7	Harmony Dancers	Kaltenthaler/Bradt	Mountainside, NJ	PL/RD/A tips
8	Al'e'Mo Sqs.	Callahan	Brooklyn, NY	MS/PL tips]
	Belles & Beaux	Mazziotti/Kaltenthaler	Glen Rock, NJ	Student
9	Spinning Wheels	Summers/Gesumaria	Wayne, NJ	MS/PL tip/CW
10	Dingman Dancers	Murphy	Milford, PA	MS/PL tip
	Lakeland Sqs.	Kaltenthaler	Parsippany, NJ	MS/PL tip
11	Cross Trail Sqs.	Mitchell/Pickett	Caldwell, NJ	PL/RD/A-1 tip
12	Rutgers Promenaders	Gottas or Kofts	N. Brunswick, NJ	MS/RD
13	Bee Sharps	Anfinsen/Bradt	Bridgewater, NJ	PL/RD
	Kittatinny Rangers	Richman	Andover, NJ	Alt. MS & PL
	Rockland Promenaders	Bourassa	Tappan, NY	MS
	Y Squares	Koft/Kushla	Clark, NJ	MS/R
14	Country Promenaders	Landi/Bradt	Edison, NJ	PL/RD
	Richmond Dancers	Mazziotti	Staten Island, NY	PL
	Western Wheelers	Coy/Raspa	Oradell, NJ	PL/RD/A tips
15	F.A.D. Sqs.	Pasvolsky	Paramus, NJ	MS/PL tip/CW
	Kings Sqs.	Emory	Brooklyn, NY	PL
	Kittatinny Dinner Dance	Fioretti/Page/Pickett	Budd Lake, NJ	MS/PL/RD
16	Spinning Wheels	Robinson/Gesumaria	Wayne, NJ	MS/PL tip/CW
17	Grand Square Deadline for Summer Issue			
	Hi Taw Twirlers	Leber/Raspa	New Milford, NJ	PL/RD/A-2 tip
	Lakeland Sqs.	Mitchell/Bichler	Parsippany, NJ	MS/PL tip/CW
18	Belles & Beaux	Mazziotti	Glen Rock, NJ	MS/PL tips
	Ironia Reelers	Landi	Wayne, NJ	A-2
19	Hix & Chix	Snyder/Raspa	Elmwood Park, NJ	PL/RD
	Valley Sqs.	Leber/Bradt	Berkeley Heights, NJ	PL/RD
	Warren Wheelers	Pasvolsky	Port Murray, NJ	Alt MS & PL
20	Hunterdon Flutterwhls.	Mitchell/Dockry	Stanton Station, NJ	Alt MS & PL/RD
	Ironia Reelers	Snyder/Pickett	Randolph, NJ	PL/RD
	Ocean Waves	Koft	Staten Island, NY	MS/PL tips
	Tenakill Twirlers	Richman	Cresskill, NJ	MS/RL tip

Continued on page 63

March contd:

21	Harmony Dancers See Saw Sqs.	Kaltenthaler/Bradt Koft	Mountainside, NJ Up. Saddle River, NJ	PL/RD/A tips PL/A tip
22	Al'e'Mo Sqs. Motiv8ors	Pearce Uebelacker/Pickett	Brooklyn, NY TBA	MS/PL tips A-2/RD/C-1 tip
23	Spinning Wheels	Conklin/Gesumaria	Wayne, NJ	MS/PL tip/CW
24	Dingman Dancers Hi Taw Twirlers Lakeland Sqs.	Murphy Ritucci/Raspa Richman/Pickett	Milford, PA New Milford, NJ Parsippany, NJ	MS/PL tip A-2 MS/PL tip/RD
25	Cross Trail Sqs.	Snyder/Raspa	Caldwell, NJ	PL/RD/A-1 tip
26	Rutgers Promenaders	Gottas or Kofts	N. Brunswick, NJ	MS/RD
27	Bee Sharps Circle Eights Kittatinny Rangers Y Squares	Mazziotti/Pickett Longobucco Anfinsen Riviccio/Kushla	Bridgewater, NJ Haworth, NJ Andover, NJ Clark, NJ	PL/RD MS/PL tip Student MS/R
28	Country Promenaders Richmond Dancers Western Wheelers	Sparks/Bradt Gotta/Gotta TBA/Raspa	Edison, NJ Staten Island, NY Oradell, NJ	PL/RD PL/RD PL/RD/A tips
29	Cross Trail 30th Ann. Motiv8ors	Bryant Wilson/Raspa	Lincoln Park, NJ TBA	PL/A-2 A-2/RD/C-1 tip
30	Spinning Wheels	Weiner/Gesumaria	Wayne, NJ	MS/PL tip/CW
31	Dingman Dancers Hi Taw Twirlers Lakeland Sqs.	Murphy Flego/Raspa Hemler/Bichler	Milford, PA New Milford, NJ Parsippany, NJ	MS/PL tip PL/RD/A-2 tip MS/PL tip/CW

April:

1	Belles & Beaux Mountain Sqs.	Kaltenthaleri Landi	Glen Rock, NJ Whippany, NJ	MS/PL tips A-2
2	Valley Sqs. Warren Wheelers	Snyder/Bradt TBA	Berkeley Heights, NJ Port Murray, NJ	PL/RD Alt MS & PL
3	Hunterdon Flutterwhls. Ironia Reelers Ocean Waves RockyTops	Hoff/Dockry Landi/Pickett Coy Matthew/Raspa	Stanton Station, NJ Randolph, NJ Staten Island, NY Up. Saddle River, NJ	Alt MS & PL/RD PL/RD MS/PL tips PL/A-1 tip/RD
4	Harmony Dancers	Landi/Bradt	Mountainside, NJ	PL/RD/A tips
5	F.A.D. Sqs. Kings Sqs.	Summers Schlyer	Paramus, NJ Brooklyn, NY	MS/PL tip/CW PL
6	Spinning Wheels	Robinson/Gesumaria	Wayne, NJ	MS/PL tip/CW
7	Hi Taw Twirlers Lakeland Sqs.	Felleggy/Raspa Mitchell/Pickett	New Milford, NJ Parsippany, NJ	PL/RD/A-2 tip MS/PL tip/RD
8	Cross Trail Sqs.	Mitchell/Roberts	Caldwell, NJ	PL/RD/A-1 tip
9	Rutgers Promenaders	Gottas or Kofts	N. Brunswick, NJ	MS/RD
13	Spinning Wheels	Coy/Gesumaria	Wayne, NJ	MS/PL tip/CW
14	Dingman Dancers Lakeland Sqs.	Murphy TBA	Milford, PA Parsippany, NJ	MS/PL tip MS/PL tip
15	Belles & Beaux Mountain Sqs.	McFarland Landi	Glen Rock, NJ Whippany, NJ	MS/PL tips A-2
16	Hix & Chix Valley Sqs.	Kaesler/Raspa Koft/Bradt	Elmwood Park, NJ TBA	PL/RD PL/RD
17	Hunterdon Flutterwhls. Ironia Reelers Tenakill Twirlers	Hardys/Kushla Coy/Pickett Mazziotti	Stanton Station, NJ Randolph, NJ Cresskill, NJ	Alt MS & PL/RD PL/RD MS/RL tip
18	Harmony Dancers	Kaltenthaler/Pickett	Mountainside, NJ	PL/RD/A tips
19	F.A.D. Sqs. Kings Sqs. Motiv8ors	McFarland Corey Page/Raspa	Paramus, NJ Brooklyn, NY Paramus, NJ	Student PL A-2/RD/C-1 tip
20	Spinning Wheels	Robinson/Gesumaria	Wayne, NJ	MS/PL tip/CW
21	Lakeland Sqs.	Johnson/Bichler	Parsippany, NJ	Graduation
22	Belles & Beaux Cross Trail Sqs.	Mazziotti Kaltenthaler/Bradt	Glen Rock, NJ Caldwell, NJ	Graduation PL/RD/A-1 tip
23	Rutgers Promenaders	Gottas or Kofts	N. Brunswick, NJ	MS/RD
24	Bee Sharps Circle Eights Kittatinny Rangers Y Squares	TBA/Novak Woerner Kapnick Pasvolsky/Kushla	Bridgewater, NJ Haworth, NJ Andover, NJ Clark, NJ	PL/RD Student Alt. MS & PL MS/R
25	Country Promenaders Richmond Dancers Warren Wheelers	Snyder/Bradt Riviccio Flego/Novak	Edison, NJ Staten Island, NY Broadway, NJ	Graduation PL Alt MS & PL/RD

Continued on page 64

April contd:

25 contd	Western Wheelers	Page/Raspa	Oradell, NJ	PL/RD/A tips
26	<i>Al'e'Mo Sqs.</i>	<i>Coy</i>	<i>Brooklyn, NY</i>	<i>Graduation</i>
	NNJSDA Graduates Ball	Many callers	Livingston, NJ	Student
27	Spinning Wheels	Woerner/Gesumaria	Wayne, NJ	MS/PL tip/CW
28	Dingman Dancers	Murphy	Milford, PA	MS/PL tip
	Hi Taw Twiriers	Kaltenthaler/Raspa	New Milford, NJ	PL/RD/A-2 tip
	Lakeland Sqs.	Coy/Pickett	Parsippany, NJ	MS/PL tip/RD
29	Mountain Sqs.	Kaltenthaler	Whippany, NJ	A-1
30	Hix & Chix	Greer/Raspa	Elmwood Park, NJ	PL/RD
31				

May:

1	<i>Hunterdon Flutterwhls.</i>	<i>Hoff/Dockry</i>	<i>Stanton Station, NJ</i>	<i>Graduation</i>
	<i>Ironia Reelers</i>	<i>Ritucci/Roberts</i>	<i>Randolph, NJ</i>	<i>PL/RD</i>
	<i>Ocean Waves</i>	<i>Mazziotti</i>	<i>Staten Island, NY</i>	<i>MS/PL tips</i>
	<i>RockyTops</i>	<i>Paris/Raspa</i>	<i>Up. Saddle River, NJ</i>	<i>PL/A-1 tip/RD</i>
2	Harmony Dancers	Kaltenthaler/Kushla	Mountainside, NJ	PL/RD/A tips
3	F.A.D. Sqs.	Martellacci	Paramus, NJ	MS/PL tip/CW
	<i>Kings Sqs.</i>	<i>Riviccio</i>	<i>Brooklyn, NY</i>	<i>Graduation</i>
	<i>Motiv8ors</i>	<i>Greer/Raspa</i>	<i>Paramus, NJ</i>	<i>A-2/RD/C-1 tip</i>
	NNJSDA Delegates Meeting		Elmwood Park, NJ	
4	Spinning Wheels	Robinson/Gesumaria	Wayne, NJ	MS/PL tip/CW
5	Hi Taw Twirlers	Ritucci/Raspa	New Milford, NJ	PL/RD/A-2 tip
	Lakeland Sqs.	Mitchell/Pickett	Parsippany, NJ	MS/PL tip/RD
6	Belles & Beaux	Martellacci	Glen Rock, NJ	MS/PL tips
	Mountain Sqs.	Landi	Whippany, NJ	A-2
7	Valley Sqs.	Coy/Bradt	Berkeley Heights, NJ	PL/RD
	Warren Wheelers	Conklin	Port Murray, NJ	Alt MS & PL
8	Kittatinny Rangers	Lutcher	Andover, NJ	Alt. MS & PL
	<i>Rockland Promenaders</i>	<i>Mazziotti/Hanhurst</i>	<i>Tappan, NY</i>	<i>Graduation</i>
9	Country Promenaders	Diven/Diven	Edison, NJ	PL/RD
	Richmond Dancers	Potts	Staten Island, NY	PL
	Western Wheelers	Coy/Raspa	Oradell, NJ	PL/RD/A tips
11	Spinning Wheels	Pasvolsky/Gesumaria	Wayne, NJ	MS/PL tip/CW
12	Dingman Dancers	Murphy	Milford, PA	MS/PL tip
	Lakeland Sqs.	Wadel	Parsippany, NJ	MS/PL tip
13	<i>Cross Trail Sqs.</i>	<i>Kapnick</i>	<i>Caldwell, NJ</i>	<i>Graduation</i>
14	Rutgers Promenaders	Gottas or Kofts	N. Brunswick, NJ	MS/RD
15	Hunterdon Flutterwhls.	Pearce/Booz	Stanton Station, NJ	Alt MS & PL/RD
	<i>Ironia Reelers</i>	<i>Flego/Koft</i>	<i>Randolph, NJ</i>	<i>PL/RD</i>
	<i>Ocean Waves</i>	<i>Richman</i>	<i>Staten Island, NY</i>	<i>MS/PL tips</i>
	<i>Tenakill Twirlers</i>	<i>Martellacci</i>	<i>Cresskill, NJ</i>	<i>MS/RL tip</i>
16	Harmony Dancers	Scearce/Booz	Mountainside, NJ	PL/RD/A tips
	See Saw Sqs.	Richman	Up. Saddle River, NJ	MS
17	F.A.D. Sqs.	Mazziotti/Amateurs	Paramus, NJ	MS/PL tip/CW
	<i>Kings Sqs.</i>	<i>TBA</i>	<i>Brooklyn, NY</i>	<i>MS</i>
	<i>Motiv8ors</i>	<i>TBA/Raspa</i>	<i>TBA</i>	<i>A-2/RD/C-1 tip</i>
19	Hi Taw Twirlers	Bates/Raspa	New Milford, NJ	PL/RD/A-2 tip
	Lakeland Sqs.	Mitchell/Bichler	Parsippany, NJ	MS/PL tip/CW
20	Belles & Beaux	Mazziotti	Glen Rock, NJ	MS/PL tips
	Mountain Sqs.	Landi	Whippany, NJ	A-2
21	Hix & Chix	Matthew/Raspa	Elmwood Park, NJ	PL/RD
	Valley Sqs.	Foote/Bradt	Berkeley Heights, NJ	PL/RD
	Warren Wheelers	Koft/Koft	Port Murray, NJ	Alt MS & PL/RD
22	Circle Eights	Push	Haworth, NJ	MS/PL tip
	Kittatinny Rangers	Anfinen	Andover, NJ	Alt. MS & PL
23	Richmond Dancers	Amor	Staten Island, NY	PL
24	<i>Al'e'Mo Sqs.</i>	<i>Harper</i>	<i>Brooklyn, NY</i>	<i>MS/PL tips</i>
26	Dingman Dancers	Murphy	Milford, PA	MS/PL tip
	Lakeland Sqs.	Ciarik/Pickett	Parsippany, NJ	MS/PL tip/RD
27	Cross Trail Sqs.	TBA/Bichler	Caldwell, NJ	PL/A tip/CW
28	Rutgers Promenaders	Gottas or Kofts	N. Brunswick, NJ	MS/RD
30	NNJSDA Special Dance	Bates/McGee	Lincoln Park, NJ	PL/RD

Continued on page 65

Non NNISDA Clubs:

January:

30 Masqueraders Diven/Diven East Windsor, NJ PL/RD

February:

6 Masqueraders TBA/Rumble East Windsor, NJ PL/RD

7 M & M Sqs. Mazziotti Park Ridge, NJ Basic

20 Masqueraders Gaunt/Rumble East Windsor, NJ PL/RD

March:

6 Masqueraders Kaesler/Denniston East Windsor, NJ PL/RD

7 M & M Sqs. Mazziotti Park Ridge, NJ Basic

20 Masqueraders Leber/Rumble East Windsor, NJ PL/RD

April:

3 Masqueraders Kaesler/Rumble East Windsor, NJ PL/RD

4 M & M Sqs. Mazziotti Park Ridge, NJ Basic

17 Masqueraders Snyder/Sandstrom East Windsor, NJ PL/RD

May:

1 Masqueraders Kaesler/Rumble East Windsor, NJ PL/RD

2 M & M Sqs. Mazziotti Park Ridge, NJ Basic

15 Masqueraders Franks/Rumble East Windsor, NJ PL/RD

Round Dance Classes:

April:

14 and every Tuesday Gotta North Brunswick, NJ Phase 1

Workshops:

January:

19 and every Monday-Rock'A'Ways Kaltenthaler Boonton Twnshp, NJ A-2 WS

23 Circle Eights PL WS first 1/2 hour of all dances Haworth, NJ PL WS

February:

15, 22 Harmony DBD PL WS Richman Mountainside, NJ PL WS

March:

8, 15, 22, 29 Harmony DBD PL WS Richman Mountainside, NJ PL WS

Conventions, Festivals, Specials, & Weekends

January:

25 Harmony Afternoon RDs Rumble Cranford, NJ All Phases

February:

1 B-T & P-J Districts Callahan/Rumble Hamilton Sq., NJ PL/RD

22 CCNJ Spring Dance Many callers Elmwood Park, NJ Student

March:

1 B-T & P-J Districts Franks/Rumble Hamilton Sq., NJ PL/RD

15 Kittatinny Dinner Dance MS/PL/RD Fioretti/Page/Pickett Budd Lake, NJ

29 Cross Trail 30th Ann. Bryant Lincoln Park, NJ PL/A-2

April:

25 Warren Wheelers Flego/Novak Broadway, NJ Alt MS & PL/RD

May:

8-Sept 27 Cherry Ridge Wknds. Many callers/cuers Honesdale, PA All Programs

June:

12 Moonlight on Hudson TBA Alpine, NY MS

13 Hunterdon Flutterwhls. Koft/Koft Stanton Station, NJ Alt MS & PL/RD

18-20 Natl. A & C Conv. 15 callers Louisville, KY A-2/C-1 to C-4

24-27 47th NSDC Many callers/cuers Charlotte, NC All Programs

July:

17-19 *Cherry Ridge Wknd. Gotta/Gotta Honesdale, PA A-2/RD

August:

1 Docking Dance 12 callers/5 cuers Whiting, NJ All Programs

31-Sept 3 *Cherry Ridge Wknd. Gotta/Jacobs/Miller Honesdale, PA PL/A

GRAND SQUARE ASSESSMENTS

are being prepared and will be mailed to the Presidents shortly.

Please return your check promptly.

Cross Trail Squares

30th Anniversary

Sunday March 29th, 1998
2:00 PM - 6:00 PM



Caller: **Saundra Bryant** from Chicago, Ill.

At

Scottish Rite Masonic Temple
99 Two Bridges Road
Lincoln Park, NJ

Plus Program - 3 Hrs. A - 2 Program - 1 Hr.

Square Dance Attire - Soft Soled Shoes

Inquires:

Ron Kapnick & Ruth Edison
(973) 857-8879

John & Judy Sommer
(973) 857-1370

ATTENTION STUDENT DANCERS!!!

Check Dance Calendar starting on page 61 for all the student and graduation dances in the area. The listings are italicized to help you locate them. Check the club ad and call before traveling.

ARTICLES IN THIS ISSUE . . .

Ad Makers Info -----	52	New Year Wishes -----	4
Callerlab -----	50	NNJRDLC -----	46
CCNJ Member List -----	35	NNJRDLC Member List -----	34
Dance Calendar -----	61	NNJSDA Calendar -----	4
Del-Val Convention -----	59	NNJSDA Poster Contest -----	7
Docking Dance -----	4, 34	Non Member Club News -----	49
Get Well Wishes -----	38	NSDC-Charlotte, NC -----	58
<i>Grand Square</i> Assessments -	65	Presidents' Letter -----	3
In Memoriam-Young -----	35	RD Club News -----	48
Letters to the Editors -----	5, 59	SDCNJ -----	4
Maps NNJSDA Dances ---	58, 59	SD Etiquette -----	24, 25
Mazziotti Columns -----	52, 54	Sewing Circle Squared -----	44
Member Club News Begins ---	10	Sq Dance 800 Tel # -----	2
New England Convention -----	27	Square View -----	43



Northern NJ Round Dance Leader's Council
presents the annual

Spring Festival of Rounds

Sunday, March 29, 1998
1:00-5:00 p.m.

VFW Hall, 6 Veterans Place, Elmwood Park, NJ
Get your ticket from any NNJRDLC cuer.

Info: Wagenhoffers 914-592-4613

or Raspas 201-896-1891

ADVERTISERS' INDEX

Please tell our advertisers that you saw their ad in *Grand Square*.

Al'e'Mo Sqs -----	60	Gotta RD Class -----	46	NSDC, Charlotte, NC --	19
Bee Sharps -----	30	Harmony Dancers -----	26	Ocean Waves -----	13
Belles & Beaux -----	28	Harmony DBD PL WS	23	Richmond Dancers ---	54
B&B Mystery Bus Ride	15	Hi Taw Twirlers -----	24	Rock'A'Ways A-1 -----	48
Bolos & Petticoats -----	33	Hix & Chix -----	47	Rockland Prom -----	20
CCNJ Spring Dance -----	9	Hunterdon Flut -----	41	Rockytops -----	39
Cherry Ridge Wknds --	55	Ironia Reelers -----	18	Rutgers Prom -----	29
CR Schedules -----	56, 57	Kings Sqs -----	22	See Saw Sqs -----	32
Circle Eights -----	21	Kittatinny Rangers ---	49	Spinning Wheels -----	11
Country Prom -----	51	KR South of the Border	8	Sq Dance Videos -----	25
Cross Trail Sqs -----	42	Lakeland Sqs. -----	36	Stapenell -----	9
CT 30th Anniversary --	66	M & M Sqs -----	40	Sun. at Nottingham ---	31
Dingman Dancers -----	49	Masqueraders -----	50	Tenakill Twirlers -----	10
Docking Dance -----	34	Motiv8ors -----	14	Valley Sqs -----	37
F.A.D. Sqs -----	17	Mountain Sqs. -----	34	Warren Wheelers -----	19
Forman Calling Again-	45	Natl. A&C Conv. -----	53	Warren 30th Ann. -----	6
Gotta Dance -----	38	NNJRDLC -----	67	Western Wheelers ---	27
Gotta Cherry Ridge ---	12	NNJSDA -----	3, 5, 7, 50	Y Squares -----	16

NNJSDA MEMBER CLUBS

See club articles (alphabetically A-Z) and ads for further information. Advertisers Index appears on inside back cover. Clubs desiring to change dance night or location **MUST** contact the Recording Secretary (listed on page 2) for Clearance.

Abbr: A=Advanced; Alt=Alternate; CW=Country & Western; MS=Mainstream; PL=Plus.

MAINSTREAM

PLUS

	Weeks of the Month:
Sunday:	
Al'e'Mo Sqs	2, 4 Sept-Jun
F.A.D. Sqs.	1, 3 Sept-Jun
Monday:	
Spinning Whls	Every Wk. Sept-Jun 2, 4 Jul-Aug
Tuesday:	
Belles & Beaux	2, 4 Jun-Aug
Dingman Dncrs	2, 4, 5 Mar-Dec
Lakeiland Sqs	Every Wk Sept-Jul
Wednesday:	
Belles & Beaux	1, 3 Sept-May
Thursday:	
Rutgers Prom.	2, 4 Sept-May
Warren Whlrs.	1, 3 Sept-Jun
Friday:	
Circle Eights	4 Sept-Jun
Hunterdon Flutterwh.	1, 3 Sept-Jun
Kittatinny Rangers	2, 4 Sept-Jun
Ocean Waves	1, 3 Sept-Jun
Rockland Prom.	2 Sept-Jun
Tenakill Twirlers	3 Oct-May
Y Squares	2, 4 Sept-May

	Weeks of the Month:
Sunday:	
Kings Sqs.	1, 3 Sept-Jun
Tuesday:	
Hi Taw Twirlers	1,3, 5 Sept-Jun
Wednesday:	
Cross Trail Sqs.	2, 4 Sept-Jun
Thursday:	
Hix & Chix	2, 4 Sept-Dec 3 starting Jan '98
Valley Sqs.	1, 3 Sept-Jun
Warren Whlrs.	1, 3 Sept-Jun
Friday:	
Bee Sharps	2, 4 Sept-Jun
Hunterdon Flutterwh.	1, 3 Sept-Jun
Ironia Reelers	1, 3 Sept-Jun
Kittatinny Rangers	2, 4 Sept-Jun
Rockytops	1 Oct-Jun
Saturday:	
Country Prom.	2, 4 Sept-May
Harmony Dancers	1, 3 Sept-May
Richmond Dancers	2, 4 Sept-Jun
See Saw Sqs.	3 Sept-Jun
Western Whlrs.	2, 4 Sept-Jun

ADVANCED

Sunday:	Wednesday:
Motiv8ors (A-2) 1, 3 some 5 Sept-Jun Every Jul-Aug	Mountain Sqs. (A-2) 1, 3, 5 Sept-Jun A-1: Jan, Feb & Apr. 29

DANCES CANCELLED

January:	April:	May:
19 - Spinning Wheels	10-12 - All Clubs	23 - Western Wheelers
February:	16 - Warren Wheelers	
16 - Spinning Wheels	18 - NJ Convention	
18 - Belles & Beaux	29 - Belles & Beaux	

MAR 18 - MOUNTAIN

Dingman Dancers and Leisure Squares do not
dance in January and February.

*The Editors of **Grand Square** reserve the right to edit, correct, or otherwise modify
articles or ad copy submitted for publication. Signed articles and letters are
the opinions of the authors and not necessarily those of the NNJSDA.*