

Grand Square

OFFICIAL

PUBLICATION

NORTHERN NEW JERSEY SQUARE DANCERS ASSOCIATION
Vol. 39 - No. 1 Fall Issue Sept.-Oct.1996

SQUARE DANCING WHAT'S MISSING?



THAT'S RIGHT...UR

SO GET UR-SELF INTO A SQUARE-
JUST FOR THE FUN OF IT!

HELP US CELEBRATE

Congratulations to our

Poster Contest Winners

Bill & Alice Lambert

of Y Squares

SEPTEMBER IS NATIONAL SQUARE DANCE MONTH

Grand Square

OFFICIAL PUBLICATION

EDITORS EMERITUS :

Doc & Peg Tirrell

EDITORS:

Charlie & Kathy Porter

99 Stanley Ave, Staten Island, NY 10301

Home: 718-448-9761

Kathy Office: 201-938-5517

Fax: 201-938-5466

Internet: kathy_porter@trs.dowjones.com

FOR OVERNIGHT DELIVERIES ONLY

Kathy Porter c/o Dow Jones Telerate

Harborside Fin. Ctr., 600 Plaza Two

Jersey City, NJ 07311

Associate Editors:

Greg & Karen Kushla

201-593-8440

Billing:

Leo & Lois Bichler

718-356-2208

Northern Area Reporter:

Henry Shiman

201-866-0723

Southern Area Reporter:

Frank & Helen Cavanaugh

609-859-1937

Western Area Reporter:

Donna Poyer

908-852-9285

Western Area Distribution:

Bill & Erma Donaldson

201-627-7975

NNJSDA OFFICERS 1996-1997

Pres: Sal & Mary Alessi
5 Villa Rd. Little Falls, NJ 07424
201-256-1647

1st VPs: Richard & Rusty Ball
52 Kiel Ave, Kinnelon, NJ 07405
201-838-0312

2nd VPs: Richard & Linda O'Keefe
595 Northfield Ave, #58, W. Orange,
NJ 07052 201-243-0192

3rd VPs: Gus & Marilyn Bachmann
258 Stevens Ct, New Milford, NJ
07646 201-261-3921

Rec Sec: Margaret Guyre
79 Shadyside Ave, Dumont, NJ
07628 201-384-2791

Corr Sec: Bernie & Sandy Beck
657 Prospect St, Glen Rock, NJ
07452 201-447-0538

Treas: Jim & Barbara Thoma
8 Wilson Ave, Staten Island, NY
10308 718-948-3056

PUBLISHED BI-MONTHLY SEPT-MAY

Circulation: over 1,700

Deadlines	Due Out:	Theme:
Sept 17, '96	Nov. 10, '96	Holiday
Nov. 17, '96	Jan. 19, '97	Winter
Jan. 17, '97	Mar. 9, '97	Grads
Mar. 17, '97	May 4, '97	Summer
July 17, '97	Aug. 30, '97	Fall

ADVERTISING RATES

Actual Size	NNJSDA Member Clubs	Non-Member Advertiser
Necessary for Camera-Ready Ads		
Full: 6"W x 10"H	\$52.00	\$57.00
1/2: 6"W x 5"H	26.00	31.00
1/4: 6"W x 2-1/2"H	13.00	18.00
1/8: 6"W x 1-1/4"H	6.50	11.00

Any ad submitted with dimensions other than listed above is not camera-ready.

Printer reduces copy by 25% when printing.

10% Discount for 5 prepaid ads, same size.

Ask Editors for details.

The following extra charges may apply:

Creating ad from rough copy	\$20.00
Corrections, sizing, etc.	5.00
Bills unpaid after 30 days	2.00

Make all checks payable to Grand Square.

Subscriptions: \$8.50 for 5 issues.

Send all ad copy, checks, articles, and subscriptions to Editors.

PRODUCTION STAFF

Sal & Mary Alessi, Leo & Lois Bichler

Greg & Karen Kushla

Asst Treas: Roger & Maria Hoernlein

36 Willow St, Bergenfield, NJ 07621

201-384-5208

Past Pres: John & Joan Berg

21 Crescent Rd, West Milford, NJ

07480 201-697-2090

COMMITTEE CHAIRMEN 1996-1997

Advisors:

Jim & Joyce Kelly 908-658-4271

CCNJ Liaisons:

Margaret Guyre 201-384-2791

Donna Brady 201-387-1135

Insurance :

Fred & Kathryn Hill 908-849-1606

NNJRDLC Liaisons:

Ralph & Marilyn Neibart 201-762-8481

SDCNJ Liaisons:

Norman & Audrey Bolin 201-729-9327

NJ State Outfit:

Rusty & Richard Ball 201-838-0312

201-697-2090 NNJSDA Square Dance Information Line
1-800-892-8828 SD Info - Sponsored by the SDCNJ & Fed Del-Val SRD

*From the computer of....***SAL & MARY ALESSI, NNJSDA PRESIDENTS**

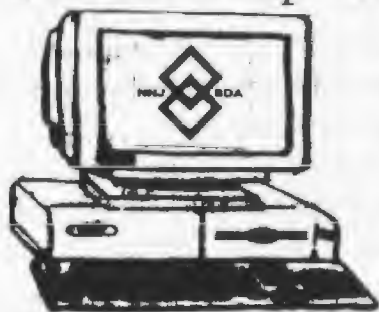

We want to thank everyone for all their good wishes. It is an eye-opener to realize how many of our 1587 NNJSDA members we have come to know. We consider all of you as part of our extended family.

On a Sunday afternoon 49 years ago, a young man in uniform wandered the streets of San Antone [sic]. He came upon a building he instantly recognized and was shocked to realize it was the Alamo.

This year Mary and I went to the 45th National Square Dance Convention held there. We were two of 135 dancers attending from New Jersey. There 16,587 dancers from all over the world to enjoy our activity.

We want to thank all those who participated in the Parade of States at the Alamodome in Texas, as well as Harry & Alberta VanLuvender and Rosina & Rick Wagenhoffer for transporting our display materials for the Showcase of Ideas and boxes of **Grand Square**. Also, thanks to John Berg for helping to set it up. The NNJSDA has had a display in the Showcase of Ideas at the NSDC for 26 consecutive years.

On a sad note, we attended Merri Eights last dance. It is ironic to note that their last dance was a successful event. We also regret the demise of Princeton Squares and Tenafly Squares. We have now been reduced to 32 member clubs, but we are pleased to report that Leisure Squares is still in business as an NNJSDA member club. In spite of any difficulties, we look forward to a successful season of square dancing.

Sal & Mary Alessi, NNJSDA Presidents

NORTHERN NEW JERSEY SQUARE DANCERS ASSOCIATION

*We need YOUR help! Know a dance hall?
BE A HERO: Tell the NNJSDA about it.*

Find out the answers to the following questions, and give us a call. There are no wrong answers--we have many different needs at different times of the year.

1. What is the rental--under \$150? Does the renter have to be from a certain community or organization to get this price?
2. Is it air-conditioned?
3. Does it have wood floors? Linoleum? Concrete?
4. Is it available on Friday nights, and Saturdays evenings before sundown?
5. Is it available on Sunday afternoons?
6. How far in advance can it be booked?
7. Is it open during school breaks and vacations?
8. How many squares does it hold (1 square = 10ft x 10ft space)?
9. Does it have bleachers?
10. What is the address?
11. Who is the person to contact to rent it? Phone number?

Call Richard & Rusty Ball, 1st VPs at 201-838-0312 today!

NNJSDA CALENDAR

September:

- 8 **Delegates Meeting**
VFW Elmwood Park, NJ
- 17 **Grand Square Deadline** for
Nov-Dec (Holiday) Issue

October:

- 6 **The Gathering**
Parsippany High School
Parsippany, NJ

November:

- 10 **22nd Mini-Festival** (All Programs)
Storey/Jacobs/Franks/Rumbies
Bridgewater-Raritan Middle Sch
Bridgewater, NJ
Grand Square Distribution of
Nov-Dec (Holiday) Issue
- 17 **Grand Square Deadline** for
Jan-Feb (Winter) Issue

December:

- 8 **NNJSDA Exec. Bd. Mtg.**

January '97:

- 17 **Grand Square Deadline** for
Mar-Apr (Grads) Issue
- 19 **Delegates Meeting**
VFW Elmwood Park, NJ
Grand Square Distribution of
Jan-Feb (Winter) Issue
- 26 **Mid Term Student Dance**
- 31 **NNJSDA Special Dance (PL)**
Brodeur

March:

- 9 **NNJSDA Exec. Bd. Mtg.**
Grand Square Distribution of
Mar-Apr (Grads) Issue
- 17 **Grand Square Deadline** for
May-Aug (Summer) Issue

April:

- 19 **NJ S & R Dance Convention**
Trenton State College,
Ewing, NJ

'ONE SQUARE IS FAIR'



Even those who surf oceans and books are talking about surfing the Internet. Virtually every computer owner has access to Internet information. Square dancers have several ways to share information electronically; some interesting discussions are taking place. Someone in your club may be familiar with square dance pages; if not, someone in your club has a son or daughter who is. Ask them to help you publicize square dancing and your particular events. If we want to attract younger dancers, then we must get the information out to them where they are--searching the Internet for information, friends, activities, new adventures.

Our theme for this year's Promo-Pak ties square dancing in with the interest in "on line" activity. We hope that with the current interest in square dance home pages, some curiosity may be piqued about the square dance activity. Our job ("our" meaning all of us who are square dancers now) is to present square dancing as a modern, in-the-nineties way of getting together with other people and having a hilarious evening of fun.

We know square dancing is a way to work out the kinks from sitting immobile at a computer. We know square dancing is a way to relieve stress. We know square dancing brings people together in a happy context. We know square dancing is a wonderful hobby. What we need to do is convince all those folks out there who have never done an "Allemande Left" since sixth grade, before it was fun to hold hands with someone of the opposite sex.

What we need to do is spread the word. Try new ways this year. Try the Internet pages. Try E-Mail to friends. Try at least three new ways of reaching folks during this promotional campaign. This year's Promo-Pak will supply at least one way of accessing square dance information on the Internet.

Legacy's ongoing project is the annual creation of a Promo-Pak with a yearly theme and pages of helpful hints for promoting square dancing. Try a new one this year in your area; plan a campaign and combine several promotional ideas.

The 1996 Promo-Pak is available from Stan & Cathie Burdick, PO Box 2678, Silver Bay, NY 12874. A check for your donation of \$5 should be made out to the Burdicks. This covers printing and postage; the remainder of the funds is used for Legacy projects. Order yours today!

The Gathering

The Gathering is sponsored by NNJ&DA:

Sunday, October 6, 1996

1 to 9pm

Darsippany High School

(Intersection of Rtes 80, 287, AND 46-- *See Map and Directions on page 69.*)

Schedule:

12:30-1:15: Registration and mainstream dancing with CCNJ callers

1:15-1:30: Introductions

1:30-2:30: Keynote speaker

2:40-3:25: Breakout Sessions #1

3:35-4:20: Breakout Sessions #2

2:30-4:30: Mainstream dancing with CCNJ callers

4:30-5:30: Bang-up Wrap-up session

5:30-7:00: Dinner Break--bring your own, pot-luck with your club (cafeteria seating available and NNJ&DA will supply coffee.) Or eat out at one of the many nearby restaurants (list will be available)

Mainstream dancing with CCNJ callers will continue through dinner break

7:00-9:00: COLLECT YOUR REWARD: Mainstream and Plus Dancing--National Caller

PLEASE NOTE: MUST ATTEND ONE AFTERNOON BREAKOUT SESSION TO EARN DANCE PASS FOR THE EVENING DANCE. NO WALK-INS ADMITTED TO DANCE.

Dress is casual or square dance attire; soft soled shoes required to dance.

PURCHASE YOUR TICKETS FROM YOUR CLUB OFFICERS,

OR SEND IN THE REGISTRATION FORM BELOW WITH \$5 PER PERSON TO:

Rusty & Richard Ball, 52 Kiel Avenue, Kinnelon, NJ 07405-2533

For further information, call 201-838-0312

NAME(s):

CLUB:

ADDRESS:

PHONE:

Once paid, your name will be placed on the pre-registered list at the door (your check is your receipt) That guarantees you the special dangle and seating at the information sessions.

Pre-registration accepted until September 15.

Rutgers Promenaders 1996 - 1997 Schedule

Regular Dances on 2nd and 4th Thursdays
8:00 pm - 10:30 pm

Date	Caller	Special Event
September 12th	Betsy & Roy Gotta Dan & Kathy Koft	
September 26th	Dan & Kathy Koft	Cookie Night
October 10th	Betsy & Roy Gotta Dan & Kathy Koft	Dance Sampler
October 24th	Betsy & Roy Gotta	Halloween Dance
November 14th	Dan & Kathy Koft	
November 28th	Thanksgiving	No Dance
December 8th	Watch for Flyers	Toys for Kids Dance
December 12th	Betsy & Roy Gotta	
January 9th	Betsy & Roy Gotta	Snowflake Dance
January 23rd	Dan & Kathy Koft	
February 13th	Betsy & Roy Gotta	
February 27th	Dan & Kathy Koft Betsy & Roy Gotta	President's Dancel Chinese Auction
March 13th	Betsy & Roy Gotta	International Night
March 27th	Dan & Kathy Koft	
April 10th	Betsy & Roy Gotta	
April 24th	Dan & Kathy Koft Betsy & Roy Gotta	Pot Luck Dinner
May 8th	Dan & Kathy Koft	Elections
May 22nd	Betsy & Roy Gotta Dan & Kathy Koft	Farewell Dance

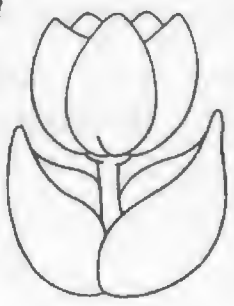

Program: Mainstream

Location: American Legion Post 459
1015 Linwood Place, North Brunswick, NJ

Squares: Betsy Gotta & Dan Koft

Rounds: Roy Gotta & Kathy Koft

Contacts: Ray Schmidt 908/613-9505
Jeff Platania 908/249-0916
Betsy & Roy Gotta 908/249-2086
Dan & Kathy Koft 908/329-8507

Directions: Take Rt. 1 to the Georges Rd. New Brunswick exit (from the north, keep to the right; from the south come back across Rt. 1 and keep to the left). At the first intersection, turn left onto Cranbury Cross Rd. At the four-way stop, turn left onto Linwood Place. The hall is on the right, just before the end of the road.

1996-1997 BEGINNER SQUARE DANCE CLASSES

Listed by: day of the week; alphabetically by hall city; club name; starting date; time (pm); hall name, address; T=Teacher; CC=Cass Coordinator's name, address, and phone number. Every effort has been made to assure the accuracy of this list. However, changes may occur, so call to confirm starting dates and halls. Please notify editors of any corrections.

SUNDAY SUNDAY SUNDAY

Hackettstown, NJ - Warren Wheelers - Open House Sept 8; 7-9:00
Hackettstown Community Center, 293 Main St; T=Herb Conklin; CC=Myrtle Jelliffe & Al Kisinski, 203 Cemetery Road, Washington, NJ 07882; 908-689-6772

MONDAY MONDAY MONDAY

Bridgewater, NJ - Bee Sharps of Somerville - Open House Sept 9; Classes start Sept 16; 7:30-9:30; Adamsville School, 400 Union Ave (Rt. 28); T=Wilson Hoff; CC=Anne Stryzak, 12 Bradley Lane, Bridgewater, NJ 08807, 908-231-1863; and Ken & Kathleen Heaphy, 103 Avonridge Rd, Raritan NJ 08869; 908-526-0943.

Newton, NJ - Kittatinny Rangers - Sept 23; 8-10:00; Halstead Street School, Halstead St; T=Mickey McFarland; CC=Kay Davis & Al Ruh, 23 Woodland Dr, Oak Ridge, NJ 07438; 201-697-7765;

Paramus, NJ - Circle Eights - Open House: Sept 16; Classes start Sept 30; 7:30-9:30; Eastbrook Middle School, Spring Valley Rd & Eastbrook Ave; T=Andy Woerner; CC=Myles & Myra Adler, 28 Valley Brook Rd, Emerson, NJ 07630; 201-261-0376; and Al & Estelle Firestone, 10 Euclid Ave, Westwood, NJ 07675; 201-666-8216.

Parsippany, NJ - Lakeland Squares - Sept 30; 7:30-10; Temple Beth Am, 879 South Beverwyck Rd; T=Pal Johnson; CC=Arlene & Tom Simansky, PO Box 291, Lake Hiawatha, NJ 07034; 201-984-0009; and Harriet & Seymour Goldsman, PO Box 291, Lake Hiawatha, NJ 07034; 201-731-4935.

Wayne, NJ - Spinning Wheels - Open House Sept 30; 7-8:00; Wayne Civic Center, Hamburg Tpk & Church Lane; classes in Oakland; see info below.

TUESDAY TUESDAY TUESDAY

Caldwell, NJ - Cross Trail Squares - Oct 8; 8-10:00; Grover Cleveland School, Academy Pl off Bloomfield Ave; T=TBA; CC=Valerie & Ismael Ramos, 126 Chestnut St, West Orange, NJ 07052; 201-325-3841,.

Clark, NJ - Y Squares - Sept 17; 7:30-9:30; Henley School, Raritan Rd; T=Dan Koft; CC=Dick & Joan Murtha, 147 Garden Dr, South Plainfield, NJ 07080; 908-757-5446.

Midland Park, NJ - F.A.D. Squares - Open House Sept 17; Classes start Sept 24; 7:30-9:30; Midland Park Community Center, 250 Prospect St; T=Dot Loewenstein & Jim Broderick; CC=Joe & Eleanor Emmerich, 609 Seventh St, Carlstadt, NJ 07072; 201-438-0421. (See Sat below for another Open House.)

WEDNESDAY WEDNESDAY WEDNESDAY

Bergenfield, NJ - Tenakill Twirlers - Sept 18; 7:30-8:50; Lincoln School; T=Fran Wadel; Info: Fanny Meyer, 236 N. Queen St, Bergenfield, NJ 07621; 201-385-3263.

Brooklyn, NY - Al'e'Mo Squares - Sept 11; 7:30-10:00; Ft. Hamilton Army Base Rec Hall, Ft. Hamilton Pkwy at 100th St.; T=Don Coy; CC=Caroline Parlato, 1018 77th Street, Brooklyn, NY 11228; 718-745-3375.

Oakland, NJ - Spinning Wheels - Oct 2; Valley Middle School, 71 Oak St; T=Bob Robinson; CC=Tom & Nora Burke, 24 Chestnut Dr, Wayne, NJ 07470; 201-694-1750; and George Haberberger & Barbara McKenna, 547 Eder Rd, Wycoff, NJ 07481; 201-891-6514.

Continued on page 8

WEDNESDAY CONTINUED

Edison, NJ - Country Promenaders - Sept 18; 7:30-9:30; Stelton Community Center, Plainfield Ave (Rt 529); T=Bob Kozarek; Info: Louis & Jan Thompson, 52 Redwood Lane, Freehold, NJ077728; 908-577-9413.

Randolph, NJ - Ironia Reelers - Sept 18; 8-10:00; Ironia Elementary School, Dover-Chester Rd (Rt 513); T=Wilson Hoff; CC=Steve & Barbara Cook, 81 Stoll St, Netcong, NJ 07857; 201-347-5522; and William & Barbara Kerr, 330 S. Morris St, Randolph, NJ 07869; 201-989-7633.

THURSDAY

THURSDAY

THURSDAY

Brooklyn, NY - Kings Squares - Sept 19; 7:30-9:30; Redeemer-St. John Lutheran Church, 939 83rd Street; T=Frank Riviccio; CC=Andy Fiorello, 752 59th Street, Brooklyn, NY 11220; 718-439-6298.

Glen Rock, NJ - Belles & Beaux - Sept 12; 7:30-9:30; Glen Rock High School, 620 Harristown Rd; T=Dick Mazziotti; CC=Flo & Bob Verhaaren, 20 Waibel Dr, Allendale, NJ 07401; 201-327-4229.

Stanton Station, NJ - Hunterdon Flutterwheels - Sept 21; 7:30-9:30; Echo Hill, Lilac Dr; T=Wilson Hoff; CC=Shirley & Art Richards, 84 Preston Dr, Somerville, NJ 08876; 908-526-4960.

SATURDAY

SATURDAY

SATURDAY

Paramus, NJ - F.A.D. Squares - Open House Sept 7; Paramus Congregational Church, 205 Spring Valley Rd, Paramus, NJ; classes on Tuesdays, in Midland Park; see info above.

BEGINNER CLASSES PLANNED - DETAILS TBA

E. Windsor, NJ Area - Masqueraders - contact Pres: Patricia & Larry Kraft, 11 Cedar Lane, E. Windsor, NJ 08520; 609-448-3981.

North Brunswick, NJ Area - Rutgers Promenaders - contact 1st VP: Jeff Platania, 30 Buttonwood Dr, Somerset, NJ 08873; 908-249-0916.

Rockland County Area - Rockland Promenaders - Contact Carol & Len Steinfield, 41 Lyncrest Dr, Moosey, NY 10952; 914-354-4374; and Tom & Bonnie Silk, 235 Betsy Ross Dr, Orangeburg, NY 10962; 914-365-0525.

PLUS CLASSES

PLUS CLASSES

PLUS CLASSES

New Milford, NJ - Hi Taw Twirlers - Tues, Oct 14; 7:30-9:30; New Milford Middle School, Roslyn Ave; T=Howard Richman; CC=Steve Weinstein, 8 Drayton St, Englewood, NJ 07632; 201-568-6418; or Bernie Beck 201-447-0538. See ad page 17.

ADVANCED CLASSES

ADVANCED CLASSES

Boonton Township, NJ - Rock"A"ways - A-1; Sept 26; 7:30-9:00; Rockaway United Methodist Ch, Valley Rd; T=John Kaltenthaler; Info: Freddie Kaltenthaler 717-646-2945; or Elsie 201-335-0127. See ad on page 59.

Red Bank, NJ - T=Betsy Gotta - Wed, Oct 9; 8-10:15; Trinity Episcopal Church, Front St; Info: Betsy 908-249-2086. See ad on page 39.

ROUND DANCE LESSONS

ROUND DANCE LESSONS

N. Brunswick, NJ - Get A-Rounds - Tues, Oct 8; Basic Class; American Legion, 1015 Linwood Pl; T=Roy Gotta & Kathy Koft; Info: Roy 908-249-2086 or Kathy 908-329-8507. See ad page 28.

Rutherford, NJ - Ramapo Rhythmaires - Mon, Sept 9; Basic Class; Annunciation Ukrainian Catholic Ch, 70 Home Ave; T=Nick Raspa; R.S.V.P.: 201-896-1891.

SPINNING WHEELS of WAYNE

MAINSTREAM EVERY MONDAY NIGHT - WAYNE CIVIC CENTER - 8:00 to 10:30

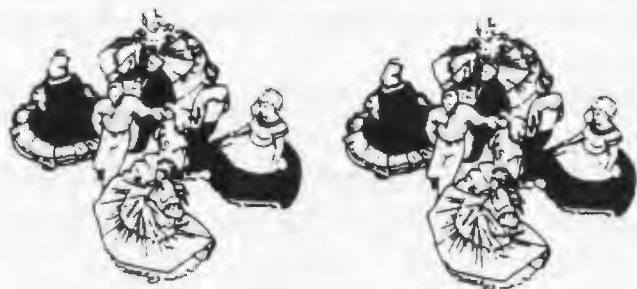

- * INTRODUCTION TO PLUS / 8:00 to 8:30
- * THIRD TIP, PLUS
- * REFRESHMENTS PROVIDED BY MEMBERS
- * WESTERN DANCING WITH DOLORES
- * MEMBERS & RAIDERS *Donation* \$2.50
- GUESTS \$3.00

CALLER SCHEDULE

SEPT	9	Bob Robinson	"FREE" APPRECIATION DANCE
	16	Stuart Summers	
	23	Gerry Hardy	
	30	Bob Robinson	"FREE" OPENHOUSE: Bring Prospective Students
OCT	7	Bob Robinson	
	14	NO DANCE	Columbus Day
	21	Manny Amor	
	28	Don Coy	Halloween Dance: Wear A Costume & Win A Prize
NOV	4	Bob Robinson	
	11	Herb Conklin	
	18	Dick Pasvolsky	
	25	Frank Revicchio	Thanksgiving Dance

PLEASE NOTE: *INTRODUCTION TO PLUS* is for ALL SQUARE DANCERS and introduces the CALLERLAB PLUS PROGRAM. The caller of the evening will review one plus figure from the previous week and introduce one new figure. Because we dance each Monday night, all plus figures on the callerlab list will be presented and then repeated.

OUR PROGRAM GIVES DANCERS PLUS INSTRUCTION FROM MANY CALLERS FOR THE PRICE OF A MAINSTREAM DANCE.

DIRECTIONS

THE WAYNE CIVIC CENTER
Church Lane & Hamburg Tpk
Wayne, NJ

TEMPLE EMAMUEL
Route 202
Oakland, NJ
(Next to Dairy Queen)

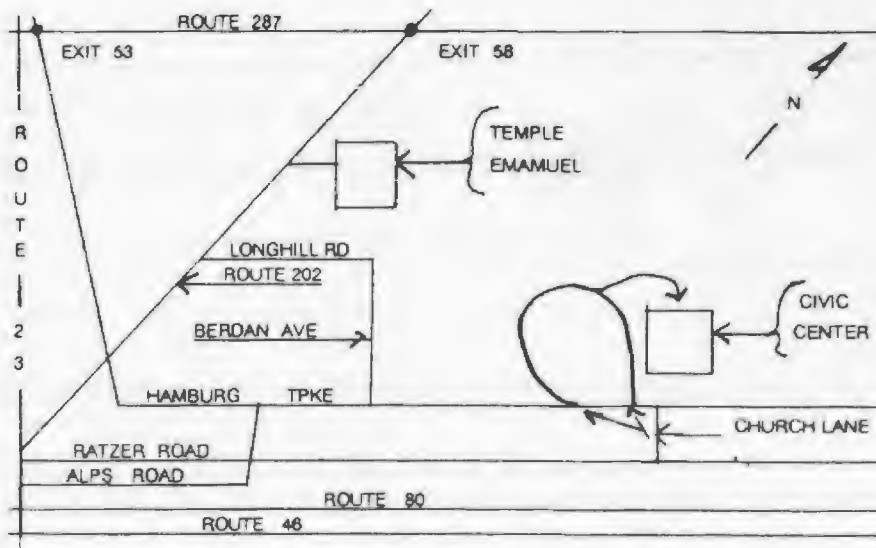

TO THE CIVIC CENTER FROM ROUTE 287 N or S: Take Exit 53 in Pompton Lakes. Turn Right at the bottom of the ramp. Not counting this traffic signal drive 5.5 mi through 12 traffic lights (follow Hospital signs). Immediately after passing through the 12th light turn Right into the Church Lane Jug-Handle, cross over Hamburg Tpke (Civic Center will be on a right diagonal) and turn into the Jug-Handle on the opposite side of Hamburg Tpke. Go 3/4 of the way around this second leg of the Jug-Handle and turn left into the Civic Center parking lot.

TO TEMPLE EMAMUEL FROM ROUTE 287 N or S: Take Exit 58 in Oakland and follow signs for Route 202 South. Go over the Railroad tracks, past a Mobil Gas Station on the right and through the next traffic light. About 1/4 mile on the left is Temple Emanuel, just before the Dairy Queen.

SPINNING WHEELS SQUARE DANCE CLUB * A GREAT PLACE TO DANCE

FOR INFORMATION CALL : DOLORES GESUMARIA (201) 337-8365 or KATHY & HOWIE STEENSTRA (201) 694-2191

LETTERS TO THE EDITORS...

This letter is partly in response to John & Joan Berg's last message in *Grand Square*, to quote, "Square dancing has always been a numbers game. The higher the number of students, the more graduates; the more graduates, the more club members...." We could not agree more with those thoughts. Unfortunately, our past recruiting has been less than effective because too few have been involved and as a result the number of prospects reached has been too small to produce an adequate number of recruits.

Next we would like to offer the proposal that *Grand Square*, an outstanding publication in its field, already available and underutilized, be considered for use as an ongoing recruiting tool. With over 1,700 copies published 5 times a year, we have a total of 8,500 copies in the hands of about 1,800 NNJSDA members over a year's time, so that distribution to club members is already in place. No future issue of *Grand Square* should ever end up in the garbage, but if it does happen, such action should be thought of as a potential missed opportunity to recruit a new dancer.

Club members should leave their ready-to-be-discarded copies of *Grand Square* in the waiting rooms of their doctor, dentist, podiatrist, chiropractor, barbershop, or hairdresser in the normal course of their visits there. These are ideal locations to capture the public's eye because there are no interruptions and people usually seek something to read while they wait. Thereby, with minimum effort, every club member becomes a year-round, persistent recruiter. These *Grand Squares* would tend to be readily picked up by other patients or clients, as no address label appears on them, suggesting they belong to no one and are free for the taking. We believe such picker-uppers can become potential prospects because they will be attracted by the social activities in our club

Please turn to page 11

***Celebrate New Year's Eve 1996
with Belles & Beaux...***



and

Don & Dot Coy!

mainstream & plus squares and country western!!

Glen Rock Community Church, Hamilton & Rock Roads
8 til 1

\$45 per couple - hot & cold buffet, champagne toast - hats - noisemakers - lots of fun & fine food!!

call Olivia (201) 385-9330 or Margaret (201) 384-2791

send reservations to: Olivia Reekie—120 Manhattan Terrace—Dumont, NJ 07628

Please make checks payable to Belles & Beaux:

name(s) _____ phone _____

address _____ town _____

club(s) _____ phone _____ number attending _____ total amount enclosed _____

Would you like to bring an hors d'oeuvres of your choice for our "cocktail hour"? yes _____ no _____
(If you have any preferences regarding seating arrangements, let us know!)

GS

M&M SQUARES

Fall Dances - Basic Program

DANCE DATES:

Saturday September 7

Saturday November 2

Saturday October 5

Saturday December 7



Pascack Reformed Church in Park Ridge

Dances are from 7:30 to 10:00

Hot Hash Basic in the middle of the dance

Call Laurie or Dick for more information (201)664-4482. (Directions: GS Pkwy to Grand Ave. East on Grand to Pascack. Right on Pascack to Church on your left (about 1/2 mile on Pascack)

Letters to the Editors continued from page 10

reports and, as a result, possibly become curious about square dancing.

For the prospect to obtain more information, we feel it is important that a local or toll-free number printed at the bottom of **Grand Square's** front cover. This assumes a telephone answering machine will be there to pick up incoming messages. Also, imprinted at the bottom, "General Information - see page (editor's choice)," which might consist of the following information: **Grand Square** is the Official Publication of the Northern New Jersey Square Dancers Association, which organization is made up of 32 square dance clubs (see back page) with about 1,800 members meeting at locations from Brooklyn to the Pennsylvania line (see under Dance Calendar near back). Square dancers, couples and singles, come from all walks of life and may include teenagers on up to their 80s. A few ongoing benefits our clubs offer are: many immediate social contacts, fun, exercise, a challenge, a low-cost night out and a convenient change of scene any night in the week, all for less than \$5.00 per person. Square dancers think of square dancing as "Friendship Set to Music."

People take up square dancing for many reasons that are as varied as the number of dancers. A few include a desire for a new outlet for social contacts and friendships such as: a couple experiencing an "empty nest," missing close friends who have moved away or passed on, singles who want to expand their social circle, a new activity to participate in, a chance to dress up, a place to go to get out of the house and have a good time at low cost. Refreshments (no alcohol) are usually provided by club members during the course of an evening. Square dance classes at low cost usually begin in September and extend to mid-spring. Call our toll free number (see front) for further information.

Jim & Catherine Douglas, Bloomfield, NJ

Club news appears in alphabetical order from A-Z.

AL'e'MO SQUARES -- Brooklyn, NY

MS/PL tips

2 & 4 Sun. Sept-June

Ft. Hamilton Comm. Rec. Bldg., Ft. Hamilton

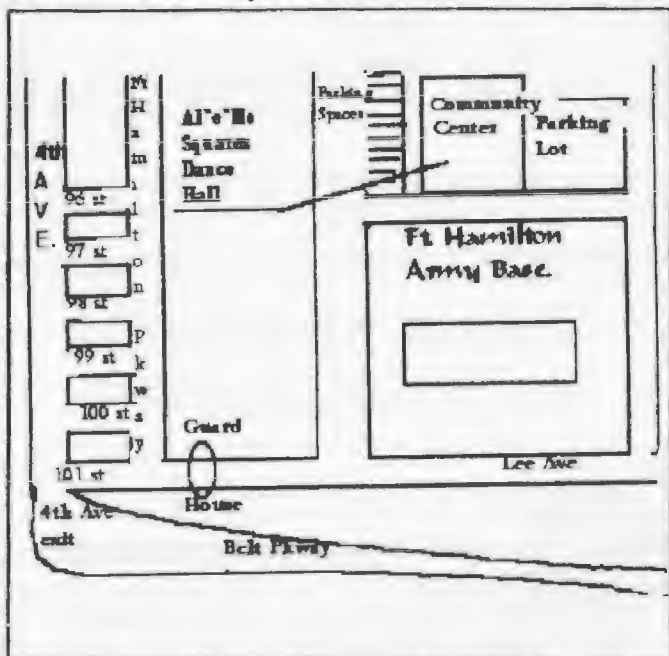

Pres: Vincent Nunziato
and Caroline Parlato
2285 Bragg St, #2E, Brooklyn, NY
11229 718-615-1507
Dele: Stan Kaplan
1605 Oriental Blvd, Brooklyn, NY
11235 718-769-7770
Cl. Coor: Vincent Nunziato
and Caroline Parlato
address as above

It's been an exciting season for our club. Our Graduation was a huge success this May. The theme was *We Are Family*. All 35 graduates came marching into the hall to that song with all 175 people singing. It was a very moving evening.

A week later we had our club elections. All officers remained the same with the exception of a new 2nd VP Mike & Kari Forti. After the election, we had our student talent show produced and directed by Helen & Arthur Schawtz. They did a tremendous job worthy of Broadway production. At the end of June we had our usual installation dinner for the new officers. They took an oath to preserve and enhance the membership and the club. We are family, especially when we break bread together. We have initiated a drawing for a FREE TOKEN for whomever comes over the bridge from the other side of the ocean.

Ad on page 64

Joe & Phyllis Piazza

718-376-3149

TENAKILL

TWIRLERS

Bryan School, Brookside Ave. Cresskill, NJ

THIRD FRIDAYS

Mainstream with one Plus Tip

Pre-Rounds 7:30-8:00 - Cuer: Nick Raspa

Squares 8:00-10:45

1996:

October	18	Dick Mazziotti
*November	8	John Kaltenthaler
December	20	John Kaltenthaler

**Note: 2nd Friday of the month*

Presidents: George & Fanny Meyer 201-385-3263

DINGMAN DANCERS

Square dancing in the northern Poconos

Rich Murphy, Club Caller
2 & 4 Tuesdays

Mainstream with Plus tip
7:30-9:30 pm

Delaware Valley High School Cafeteria
Routes 206/6, just north of Milford, PA

Sept. 10
Sept. 24

Oct. 8
Oct. 22

Nov. 5
Nov. 19

For information and directions:

Bill & Jean Gannon
Ray & Carol Proulx

717-296-4436 Days: 201-460-1700 x211
717-296-7645

BEE SHARPS -- Somerville, NJ

PL

2 & 4 Fri. Sept-June

St. John's Episcopal, 158 W. High St.

Pres: Bob & Mary King
8 Mohave Path, Somerville, NJ 08876
908-218-9007

Dele: Steve & Peggy Koehler
651 Leah Ct, Bridgewater, NJ 08807
908-526-1309

Cl. Coor: Ann Stryzak
12 Bradley Ln, Bridgewater, NJ 08807
908-231-1863

and Ken & Kathleen Heaphy
103 Avonridge Rd, Raritan, NJ 08869
908-526-0943

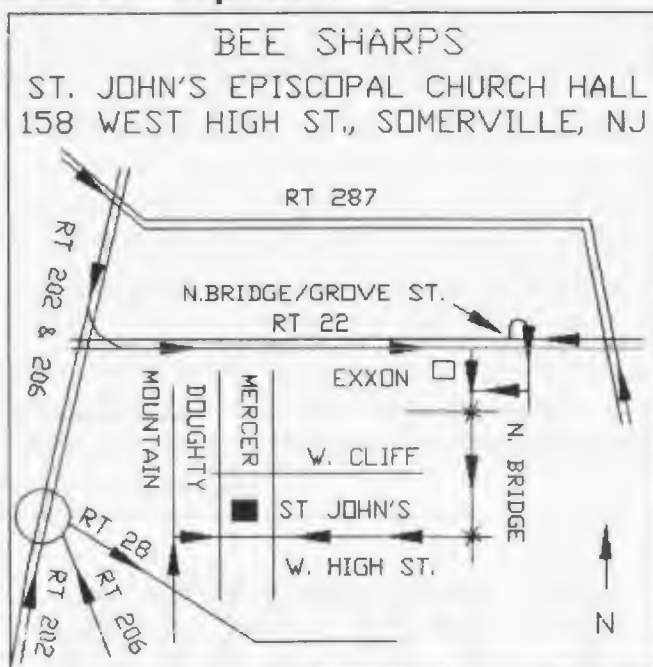

Another square dance season has passed from September Open House to Graduation. We had snow storms galore, dances cancelled, raids to north, south, central, east and west

New Jersey and Staten Island. Busy, busy, but we survived! Our officers all did their jobs expertly and the Bee Sharps are still around.

We had a Hi-Lo dance so the students can get acquainted with other square dancers. We had a delicious Pie Nite (yum, yum); Ice Cream Social (added on calories we lost during dances); had the Luck of the Irish, St. Patrick's Day Dance; and the Chinese Auction was near the tip of the cake, the top being Graduation. We also have the best of square dance teachers, Wilson Hoff.

Mike & Linda Rubenfeld were always there for us on Mondays. Congratulations to our graduates: Dian D'Amico, Lauren Cohen, Steve Gasdek, Bob Jung, Ed & Grace Klein, and Dane Lindsay. We had great angels, too many to name but they know who they are. Joan Spagnolo has been angel for 10 years, some angels for 7 years, etc. Keep coming angels; we need you.

I hope the new graduates enjoyed dancing during this past summer. I am sure square dancers everywhere welcomed you. See you in September.

Ad on page 20

Olga Pichnardzyk

908-725-0955

PATRON AWARD WINNERS

The following dancers received their Patron's Award at the May 31 Special:

Len Sodora	4th & 5th Awards
Dick & Shirley White	3rd Award
Jim & Catherine Douglas	1st Award
Joan Purchase	1st Award (took 17 years)
Bill Bohrer	1st Award

BELLES & BEAUX -- Glen Rock, NJ

MS/PL tips

1 & 3 Wed. Sept-May

Coleman School, 100 Pine Lynn Rd.

1 & 3 Tues. June-Aug.

VFW Hall, 6 Veterans Pl, Elmwood Park

Pres:

Susan Nicolich

317 W. Grand Ave, #5A, Rahway, NJ

07065

908-381-8097

Dele:

Ken & Edna Franz

41 Garwood Rd, Fair Lawn, NJ 07410

201-797-6359

Cl. Coor: Bob & Florence Verhaaren
20 Waibel Dr, Allendale, NJ 07401

What is a mystery bus raid? You don't know where you're going to eat; you don't know where you're going to dance; and you usually don't know, nor are able to really figure out, what else you will be doing en route. At least that's what a Belles & Beaux Mystery Bus Raid is! In 1995, we crossed 5 bridges (not in and around Madison

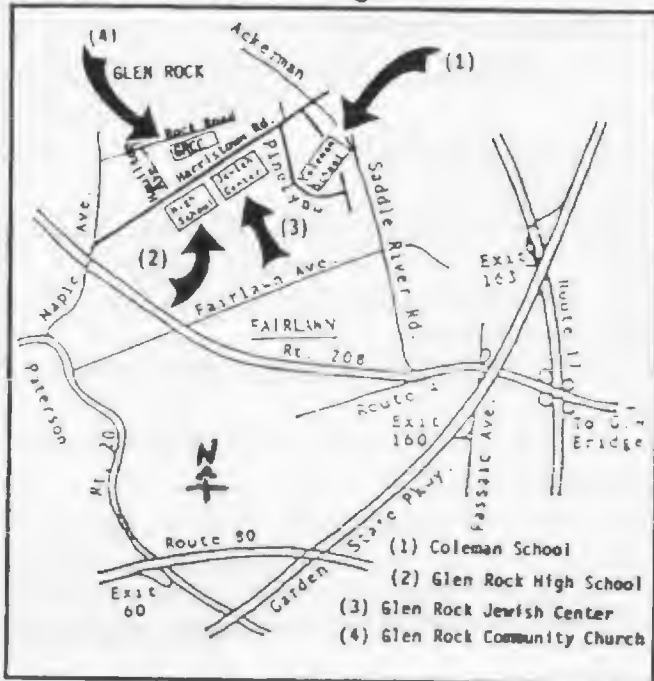

County-- but close!) and toured 5 boroughs en route to dinner and the dance.

This year, under the direction of Laurie Mazziotti, our raid chairperson, we outdid ourselves, for one bus of happy raiders, and to the pure entertainment of the other. Surely Laurie conspired with one of the bus drivers to arrange for a minor problem to occur that left one bus incapacitated in front of a restaurant outside Philadelphia. The other bus went on to our designated restaurant and was to return to pick us up--in a few minutes. While we waited, an hour, Dick did some acappella calling for some of us on the side of the highway; the restaurant

Please turn to page 15

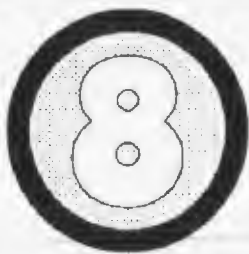

CIRCLE EIGHTS

MAINSTREAM DANCING

1996 Schedule:

Sept. 27	- Howard Richman	<i>Welcome Back</i>
Oct. 25	- Dance Cancelled	
*Oct. 27	- Bob Paris	<i>Autumn Leaves (see ad page 70)</i>
Nov. 22	- John Kaltenthaler	
Dec. 27	- Andy Woerner	<i>Student Holiday Dance</i>

Plus Workshop now being offered during first 1/2 hour of dances with the exception of Student Dances. Plus tip is last tip of dance.

*Note: Autumn Leaves Dance at Boy Scout Camp in Alpine, NJ

*Come with a partner or alone -
 at Circle Eights Everyone dances*

8 - 10:30 on 4th Fridays
St. Luke's Church

cor Massachusetts & Grant, Haworth



Info (201) 525-1925 or (201) 387-1135



OCEAN WAVES



Christ United Methodist Church
1890 Forest Avenue
Staten Island, NY 10303

1st and 3rd Fridays — 8:00 to 10:30 PM

MAINSTREAM with PLUS TIPS

<u>DATE</u>	<u>CALLER</u>	<u>THEME</u>
September 20	Dan Koft	Welcome Back
October 4	Betsy Gotta	Apple Festival
October 18	Howard Richman	* Fall Ball-Barn Dance
November 1	Nick Martellacci	Halloween Dance
November 15	Don Coy	* Thanksgiving Dance

New Graduates Welcome at all our dances!

Contacts:	Eileen Gilder	718-259-1292
	Michael Pierce	718-833-2146

* Everyone welcome - especially families.

Belles & Beaux continued from page 14

manager came out to tell us we could stay; then he sent out complementary iced tea for us. When now empty bus #2 finally returned, it was just as the clouds were about to pour on us. And it only took us 10 minutes, including a detour, to get to the designated restaurant. We still don't know where bus #2 wound up for the better part of an hour while we waited!

What with our adventure, and the rain, we had a wonderful trip! No one complained and some of us got to entertain Route 132 travelers as they passed (thereby probably earning us the right to wear a few different danglers). We had a good meal, finally, at a nice restaurant where we received marvelous service, and we still had time to tour a cathedral reminiscent of the European-style cathedrals in Bryn Athyn, PA (a must-see if you're nearby). If it wasn't raining, we could have explored the lovely grounds and gardens. We do try to give you a sampling of where we go so that you want to go back and explore on your own.

Laurie, with a little help from our host club officers (Dixie Derbys, for the curious), deserves a big THANK YOU for arranging such a wonderful day. Be sure to join us next year and find out for yourself what we'll be up to.

Thank you, thank you, thank you, to our new President, Susan Nicolich, for saving the day at our annual meeting by agreeing to be President. And to our new officers: 1st VP, Bernadette & Walter Zelop; 2nd VP, Florence & Bob Verhaaren; 3rd VP, Me; Treasurers, Donna Brady & Olivia Reekie; Asst. Treasurers, Linda Millian & Jackie Ebner; and Secretary, David Snope; a heartfelt thank you for accepting your posts! More people who have not held an office in a club should consider and step forward. No office is too difficult if you have a full slate who will work together and support one another. And most past officers are willing to help new ones settle in. A club needs support in any way you can help, not just refreshments. Remember that old picture of Uncle Sam pointing out: square dancing needs you too!

As our bus raids prove, you never know what to expect at B&B. Join us often.
Ad on page 10, 24 Margaret Guyre 201-384-2791

HUNTERDON FLUTTERWHEELS

Echo Hill Park, Lilac Drive, Stanton Station, NJ

1st & 3rd Fridays 8:00-10:15 PM Early Rounds 7:30 PM

Wilson Hoff - Caller

Peg Dockry - Cues

Alternate MS & Plus Tips

Soft sole Shoes - Please

For More Information

Stan & Sandy 908-995-7369

Art & Shirley 908-526-4960

Fall 1996 Schedule

Sep. 6 Welcome Back Dance
Sep. 20 DANCE CANCELLED

Oct. 4 Harvest Festival
Oct. 18 Masquerade Ball
(Costumes Optional)

Nov. 1 Regular dance
Nov. 15 Thanksgiving Dance

Dec. 6 Regular Dance
(Arkey Tip)
Dec. 20 Christmas Dance
(Mitten Tree)

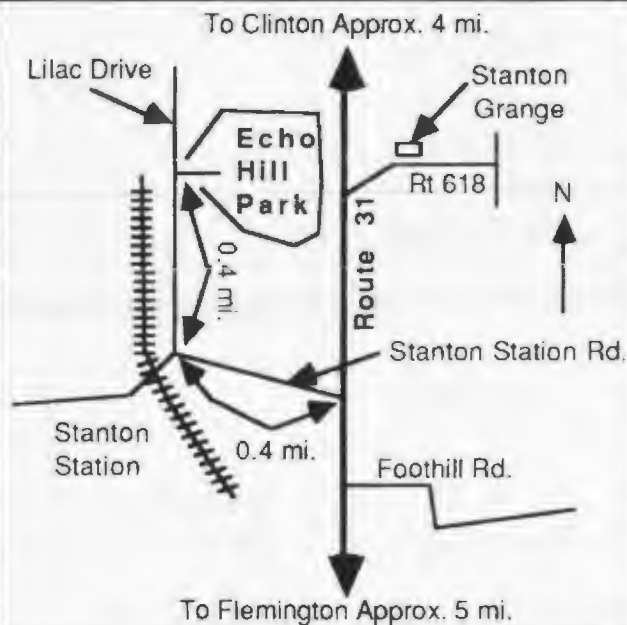

CIRCLE EIGHTS -- Haworth, NJ

MS/PL tip

4th Fri. Sept-June

St. Luke's Episcopal Ch., Mass. & Grant Aves.

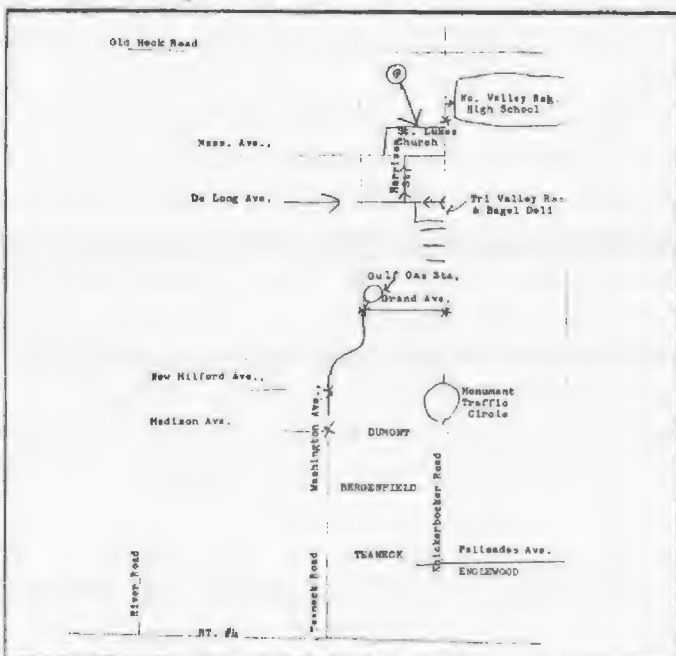

Pres: David Wolin & Susan Jurgensen
181 Bonhomme Ave, Hackensack, NJ
07601 201-525-001 (days)

Dele: Frederick Crum
392 Elm Ave, Bogota, NJ 07603
201-342-6863

Cl. Coord: Miles & Myra Adler
28 Valley Brook Dr, Emerson, NJ
07630 201-261-0376
and Al & Estelle Firestone
10 Euclid Ave, Westwood, NJ 07675
201-666-8216

Ad on page 14, 70

CLUB AD MAKERS INFORMATION

Cover these dates in your ads for upcoming issues:

Deadline

Sept. 17

Nov. 17

Jan. 17

Issue

Holiday

Winter

Graduates

Dances Between:

Nov. 10 - Jan. 31

Jan. 21 - Mar. 30

Mar. 10 - May 31

**HI TAW
TWIRLERS**

PLUS CLASS

Do you know your Mainstream calls well?

Yes	No
<input type="checkbox"/>	<input type="checkbox"/>

Are you ready to learn the Plus Program from different positions?

<input type="checkbox"/>	<input type="checkbox"/>
--------------------------	--------------------------

If you can answer "yes" to both these questions, you're eligible to sign up for an exciting, fun-filled plus class with teacher and caller

Howard Richman

Starting October 14, 1996, classes will be held every Monday from 7:30 to 9:30 p.m. for 15 weeks.

New Milford Middle School Cafeteria
Roslyn Ave, New Milford, NJ

To register for the class call
Bernie Beck
(201) 447-0538

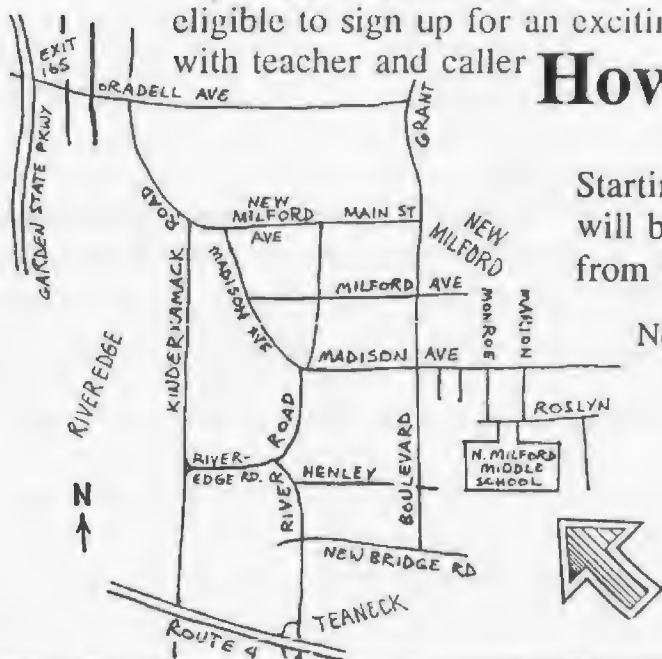

COUNTRY PROMENADERS -- Edison, NJ PL/DBD or A tip

2 & 4 Sat. Sept-May

Stelton Comm. Ctr., Plainfield Ave. (Rt. 529)

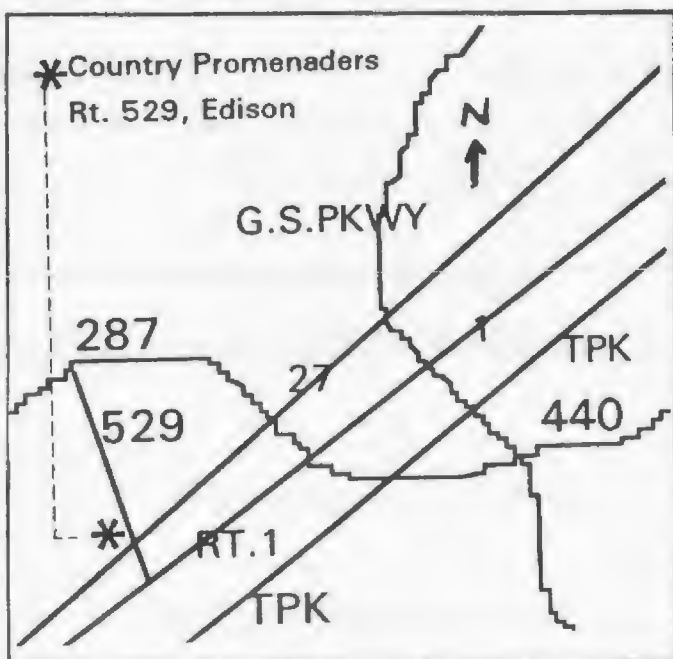

Pres: Jan & Louis Thompson
52 Redwood Lane, Freehold, NJ
07728 908-577-9413
Dele: Terry & George Seibert
104 Hill Hollow Rd, S. Plainfield, NJ
07080 908-754-1425
Cl. Coor: Jan & Louis Thompson
address as above

Despite the tornado watch, strong winds, and heavy rain we finished off the season with our Prom Nite blast. Will Larsen (CT) entertained our 12 squares of enthusiastic dancers, which included over 2 squares of raiders from Richmond Dancers, many dressed in their party finest. We could have danced all night. We'll have

another opportunity to enjoy Will's upbeat calling and music at our opening the 4th Saturday in September. We were sorry to see the Merri Eights fold. We raided their last dance with 2 squares, and look forward to being able to continue dancing with the friends we have made there. During the summer, we were very active cosponsoring the Five Clubs dances in Roselle.

The new 1996-97 season promises to be an exciting one. Long-time members and Past Presidents Bob & Grace Bishe are celebrating their 50th Anniversary. Congratulations! Remember: we welcome all single dancers, and we'll gladly help you find partners throughout the evening.

Ad on page 22, 32

Jan & Louis Thompson

908-577-9413

CROSS TRAIL SQUARES – Caldwell, NJ

PL

2 & 4 Wed. Sept-June

Lincoln School, Crane St.

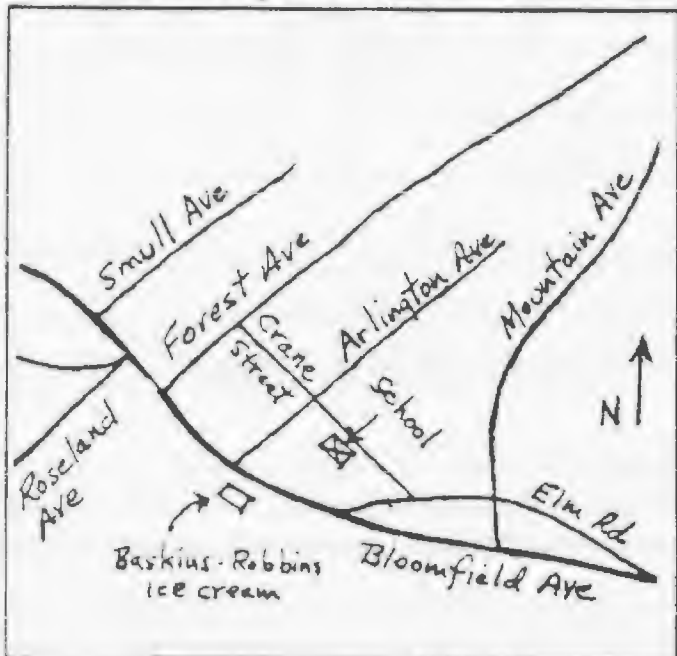

Pres: Andy & Dot Meador
 23 Center Ave, Cedar Grove, NJ
 07009-1015 201-256-5414

Dele: Ruth Edison
 30 Otsego Rd, Verona, NJ
 07044-2513 201-239-2705
 and Ron Kapnick
 PO Box 196, Little Falls, NJ
 07424-0196 201-857-8879

Cl. Coor: Ismael & Valerie Ramos
 126 Chestnut St, West Orange, NJ
 07052 201-325-3841

Cross Trail Squares graduated 8 new dancers at our May 8 dance with thanks to Andy Woerner for his expert teaching. The students also treated the angels and club officers to a graduation buffet dinner that will be long remembered.

As is our tradition, we ended the dance season with our Ice Cream Social. The officers served appreciative and hungry members and guests. Between feasts we managed to send dancers to the NJ Convention, and in June were represented at the NSDC in San Antonio. In May, we raided Ironia Reelers and Lakeland Squares. As a new promotional effort we had an Open House Barn Dance. With the help of Andy Woerner and our new graduates, the dancing of our guests was enthusiastic.

On the demo front, we once again helped Caldwell celebrate Independence Day by doing some square dance pyrotechnics before the aerial variety was touched off. Our members enjoyed their summer but are rested and ready for another season of "Fun and Friendship."

Ad on page 27

Frank & Alice Lemire

201-783-1683

STATEN SQUARE SET

SEPT. 21



**BARN DANCE
 w/ DON & DOT COY**

OCT. 5



w/ DICK MAZZIOTTI

OCT. 19

**ANNIVERSARY DANCE
 w/ DAN & KATHY KOFT**

NOV. 16**



w/ FRANK RIVICCIO

**** LOIS BICHLER DOES COUNTRY WESTERN**

St. Albans Church Hall

Plus Program

76 St. Albans Pl. Staten Is. N.Y.

8:00 - 11:00 pm

Hochuli's 718 984-8770

Emma's 718 356-1251



TURKEY TROT WEEKEND

at the
Paramount Hotel

Parksville, NY 12768
1-800-922-3498

NOV. 22, 23, 24, 1996

Dancing PLUS thru A-2 with C-1 aftertips

2 Halls

Wooden Floors



TONY OXENDINE

South Carolina



LOU FLEGO

New York

Country Western Lines - **SUE FLEGO**

RATES PER COUPLE (DOUBLE OCCUPANCY) \$339.

SINGLE OCCUPANCY \$230.

NYS TAX & Gratuities NOT included

Your \$100./couple Reservation Deposit Completely Refundable until 1 Oct. 1996

3 Superb Meals Daily
Gala Cocktail Party & Smorgasboard
Entertainment Nightly: FLOOR SHOW & Dancing
Indoor POOL & SAUNA
Complimentary Coffee, Tea & Cake Nightly
Indoor SHUFFLEBOARD & BOCCI Courts

To Make Your Reservations:
Fill Out the Reservation Form on the Bottom of This Page and Return With Deposit to:
**BEST WESTERN PARAMOUNT
TANZMAN ROAD
PARKSVILLE, NY 12768**



Deposit of \$100./couple REQUIRED, Balance Due on Arrival, Major Credit Cards Accepted

For Additional Information Contact: LOU FLEGO 516 261-7711

RESERVATION FORM: The Paramount Oxendine-Flego Weekend Nov.22-24, 1996
Dance Level: (circle one) PLUS, A-1, A-2, C-1

Name _____

Name _____

Address: _____

Address: _____

Town,State, ZIP _____

Town,State, ZIP _____

Phone _____

Phone _____

Double Occupancy _____ Single Occupancy _____

GS

*ROUND TRIP TRANSPORTATION DESIRED _____

* Why Drive? Round Trip Transportation Available Based On 10 Or More Confirming Same & Subject To Cancellation Should Minimum Not Be Met. Kindly Call DAWN McMANUS at Best Western Paramount Hotel for Special Rates & PickUp Information From Your Area. 1-800-922-3498

BEE SHARPS



of Somerville

PLUS Level Dances

2nd and 4th Friday

Early Rounds 7:30 PM

Squares 8:00 - 10:30 PM

Date	Caller 	Cuer 	Theme
Sep 27, 96	Betsy Gotta	Roy Gotta	Welcome Back Dance
Oct 11, 96	Dan Koft	Kathy Koft	
Oct 25, 96	John Kaltenthaler	Al Spinks	Halloween (Costumes Optional)
Nov 8, 96	Dalt Young	Russ Booz	President's Ball
Nov 22, 96	Howard Richman	Al Spinks	

**** Wooden Floor ****
Soft Sole Shoes a Must

Dances held at:

St. John's Episcopal Church
158 West High Street
Somerville, NJ

For More Information Contact

Mary & Bob 908-218-9007

Peggy & Steve 908-526-1309

Irma & John 908-722-3565

!!! Last Tip will be a Star Tip !!!

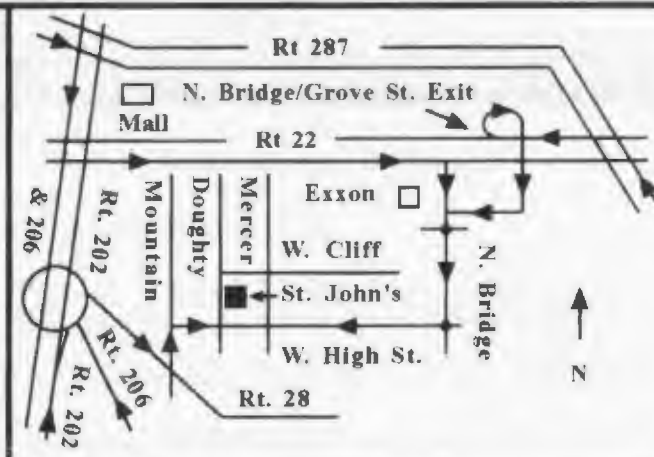

DINGMAN DANCERS -- Milford, PA

MS/PL tip

2, 4, 5 Tues. March-Dec.

Delaware Valley H.S., Routes 206 & 6

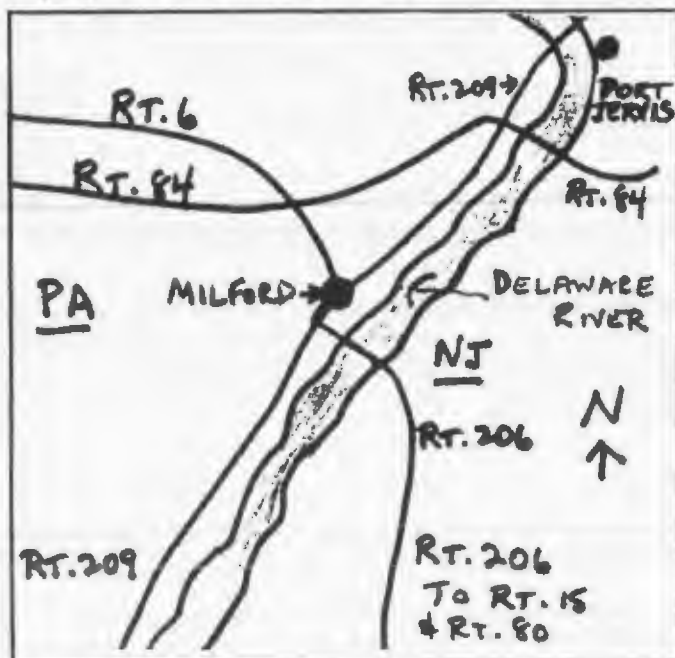

Pres: Bill & Jean Gannon
RR #1, Box 2248, Shohola, PA 18458
Home: 717-296-4436
Work: 201-460-1700

Dele: Jim Dorcas
PO Box 1255, Sparrowbush, NY 12780
914-856-3664

Cl. Coor: Jim Dorcas
address as above
and Donna Flugel

Ad on page 13

WEB SITES

The NNJSDA has a page on the www started by John Aquino:
<http://members.aol.com/jamsqs/nnjsda.html>

J & M Squares has home page on www with information
of Advanced and Challenge dances in the area.

<http://members.aol.com/jamsqs>

1 & 3 Sun. Sept-June

F.A.D. SQUARES -- Paramus, NJ

Paramus Congreg. Ch, 205 Spring Valley Rd.

MS/PL tip

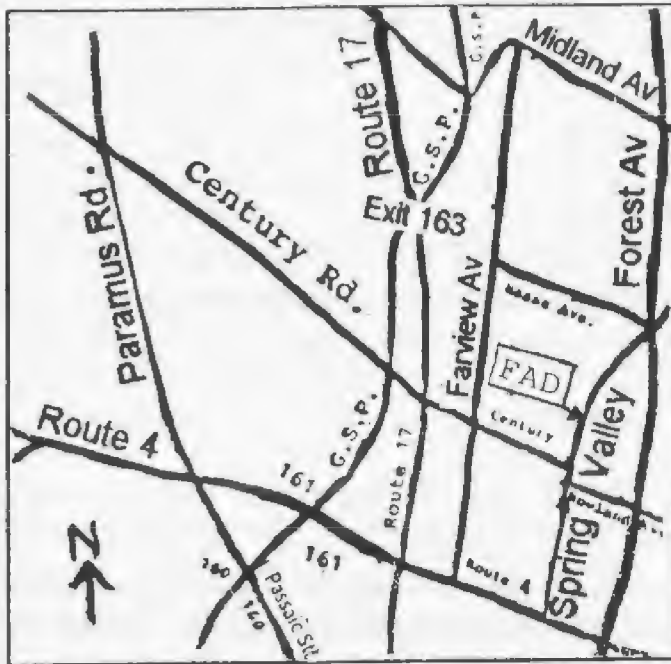

Pres. Dorothy Fels

916 E. Ridgewood Ave, Ridgewood, NJ 07450 201-447-4964

Dele: Warren & Marj Gould
123 South Highwood Ave., Glen Rock, NJ 07452 201-445-9896

Cl. Coor: Chris & Laurie O'Connor
17-30 Hunter Place, Fair Lawn, NJ 07410 201-797-6145

Dot Loewenstein has resigned as our club caller. Dot & George started this club as an interim Basics Club in 1983. During this period of over 13 years, she has taught and encouraged many people in this activity. So it is with sincere gratitude we say, "Thank you!" Dot will guest call now then.

We were shocked and saddened by the death of our former President, Don Walker, who passed away April 26. Our sympathy to his widow Fern.

Dorothy Fels was elected President for a third term. Good luck and keep up the good work. F.A.D. Squares starts this fall with guest callers. Please join us. We offer a little something for everyone: MS with a Plus aftertip and CW line dancing during breaks. So have "Fun At Dancing" with F.A.D. Squares.

Ad on page 26

Marj & Warren Gould

201-445-9896



1st AND 3rd FRIDAYS

7:30 PRE ROUNDS

8:00 PLUS LEVEL

IRONIA REELERS

IRONIA SCHOOL, (RT 513) DOVER

CHESTER ROAD, (IRONIA) RANDOLPH

09/18/96 Open House--New Class
Wilson Hoff

09/20/96 Jim Snyder
* Al Spinks

10/04/96 Don Coy
* Al Spinks

10/18/96 Dan Koft
* Kathy Koft

11/01/96 John Kaltenthaler
* Al Spinks

11/15/96 Marion Pearce
* Al Spinks

* Rounds

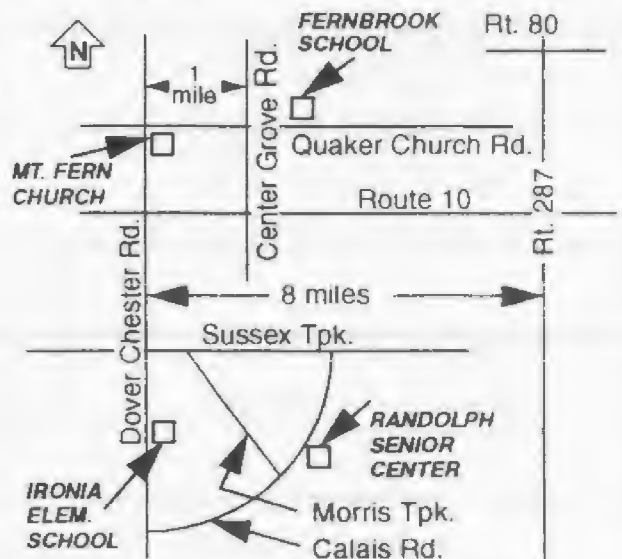

FOR MORE INFORMATION CALL:

MARY JANE AND GREG ROOME (201-543-4109)
OR

EILEEN AND BILL EBELL (201-895-2653)

1 & 3 Sat. Sept-May

HARMONY DANCERS – Springfield, NJ

PL

Chisholm Sch, S. Springfield Ave at Shunpike

Pres: Wayne & Kay Schroeder
152 Hayes Ave, Clark, NJ 07066

908-396-8286

Dele: Bill & Phyllis Tallamy
323 Chaucer Dr, Berkeley Heights, NJ
07922 908-464-0243

Harmony Dancers finished their '95-'96 season with a bang since we had two specials in May: Dan Guin and Drew Searce. Our ever-popular Ice Cream Social on the final dance was a hit as usual.

Our last dance also gave us the opportunity to thank our past Board for their help and support, and to welcome the new people to the '96-'97 Board. It is times like this when we realize it

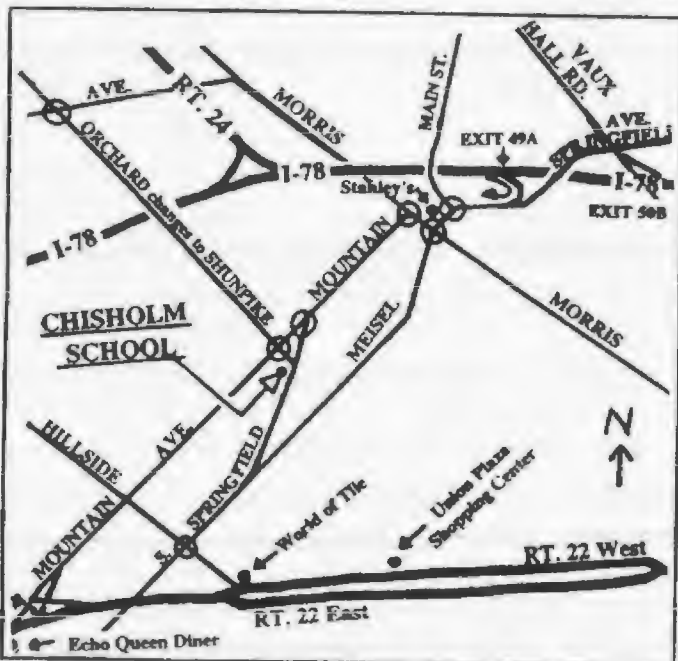

takes lots of hands too make a club happen. Sylvia Gambony, our Raid Chairperson, awarded free dance tickets to all those who attended 4 or more raids the past year. In recognition of Helen Young's many years of support to square dancing in general and Harmony Dancers in particular, she was awarded Honorary Lifetime Membership. Helen celebrated her 90th birthday last year.

We look forward to seeing you on the dance floor in the fall.

Ad on page 34

Kay & Wayne Schroeder

908-396-8286

COUNTRY PROMENADERS

★ ★ ★ PRESENTS ★ ★ ★

TWO GREAT OUT-OF-TOWN CALLERS

☺ ED ☺

FOOTE

(PENNSYLVANIA)
RENOWNED FOR
HIS SENSE OF HUMOR

☺ JOHN ☺

CARLTON

(KENTUCKY)
HALLOWEEN DANCE
COSTUMES WELCOME

SATURDAY
OCT. 12, 1996



SATURDAY
OCT. 26, 1996

PLUS LEVEL SQUARES 8:00 - 10:30 PM
EARLY ROUNDS with STEVE BRADT 7:30 PM
STELTON COMMUNITY CENTER, EDISON, NJ

Info: Jan & Louis (908) 577-9413

SEE ARTICLE FOR MAP



HIX & CHIX

VFW HALL
6 Veterans Pl. Elmwood Park
(Off Boulevard; behind Firehouse)

PLUS PROGRAM - 2nd, 4th & 5th Thursday

ROUNDS TEACH at 7:30 P.M.; SQUARE UP at 8 P.M.
Dance till 10:30 P.M.

THURSDAY NITE DANCING - CHECK SCHEDULE FOR DATES!!!
Rounds with Nick Raspa & guest cuers.

SEPTEMBER	12 Dalt Young	
	19 Dee Dee Dougherty	- SPECIAL
	26 Randy Page	
OCTOBER	10 John Kaltenthaler	- Octoberfest
	24 Gerry Hardy	- United Nations Day
	31 ???? Boo Who?	- Halloween
NOVEMBER	14 Sandy Corey	- Rosina Wagenhoffer -Cuer
	21 Howard Richman	- Country Western
	28 No Dance	- HAPPY THANKSGIVING!
DECEMBER	1 MARSHALL FLIPPO-Super Sunday Special	

Hasbrouck Heights VFW Hall

513 Veterans Place

Hasbrouck Heights, NJ

"WOODEN FLOOR" see flyer for details.

RAID HIX & CHIX with Advance Notice - pay members fee-except SPECIALS.

More Information: John & Connie Huettemann - (201)438-0948

Dick & Brenda Dexter - (201) 529-3372

HI TAW TWIRLERS - New Milford, NJ

PL/A-2 tip

1, 3, 5 Tues. Sept-June

New Milford Middle Sch., Roslyn Ave.

Pres: Judy Siegel
746 Drayton Pl, Rivervale, NJ 07652

201-391-7961

and Jill Weinberg
33 Ash Rd, Bardonia, NY 10977

914-623-8926

Dele: Dick Meyers
320 Highwood Ave, Glen Rock, NJ
07652 201-652-9353

Hi Taws Twirlers has been taking a break for the summer but is ready to resume dancing on third Tuesday in September with John Kaltenthaler calling. We have scheduled excellent callers for the '96-'97 season. They will call a high Plus program that will be friendly. New dancers as well as

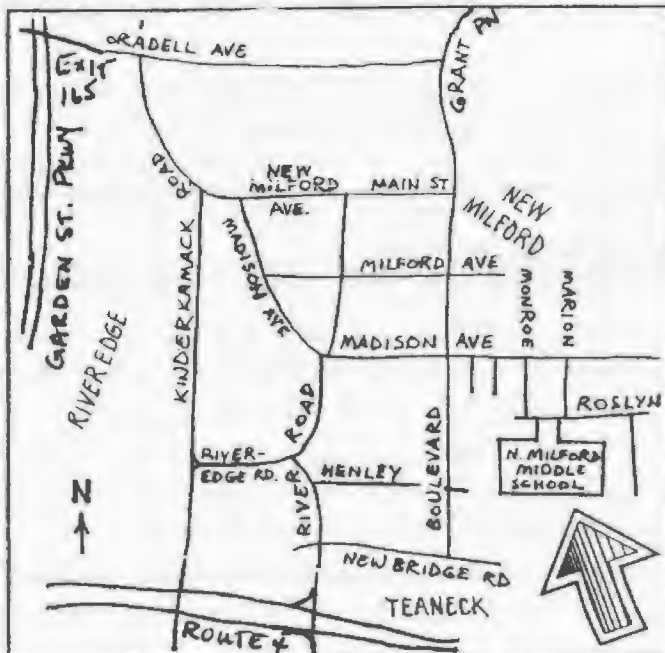

experienced dancers will enjoy the calling. See our ad and flyers for details about our new Plus class. The class will begin in October with Howard Richman teaching. Instruction will be geared to experienced Mainstream dancers as well as to Plus dancers who want to upgrade their skills.

Our new Presidents will have a tough act to follow, but they are already on the way. Under the just completed presidency of Bernie & Sandy Beck and Fred & Marion Meyer, attendance has virtually doubled from about four squares to 8.

Ad on page 17, 38

Beverly & Marty Millman

201-391-3592

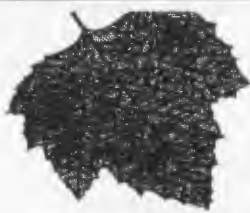

Belles & Beaux



square dance club

M (+tips)

Coleman School, 100 Pinelynn Rd., Glen Rock

(Take Route 4 to Route 208. Maple Ave. exit; Make 1st right onto Harristown Road. Pinelynn is the 1st right turn off Harristown Rd. north of the Glen Rock Jewish Center. Call for other directions!!)

1st & 3rd Wednesdays 8-10pm

Fall Square Dancing Festival!

- Sept. 4 - Mickey McFarland - Beach Party!! Wear cool and casual clothes!
- Sept. 12 - (Thursday) Open House - Glen Rock High School cafeteria! (Harristown Rd) Bring lots of non-dancing friends!
- Sept. 18 - John Kaltenthaler! - Wear your club badge and matching colors and 50-50 tickets are 2 for the price of 1!
- Oct. 2 - Randy Page - warm-up dance in anticipation of the Gathering on Sunday!
- Oct. 16 - Dick Mazziotti - B&B's Halloween bash! Costumes—prizes—surprises!
- Nov. 6 - Howard Richman - election results are in - wear red, white & blue!
- Nov. 20 - Dick Mazziotti - Thanksgiving dance--turkey raffle and all! Free "turkey 'n' trimmings" raffle ticket with donation of non-perishable food for the needy. Pie night too!
- Dec. 4 - Randy Page is back! Take some time off from your holiday shopping!
- Dec. 18 - Dick Mazziotti's here to help us welcome students!! Cookie night, and our annual toys for tots collection for the Holley Center children!
- Dec. 31 - Look for our flyers for our annual New Year's bash with Don & Dot Coy!

Questions? call Margaret 384-2791 or Rich & Rusty 838-0312



HIX & CHIX -- Elmwood Park, NJ

PL

PL - 2, 4, 5 Thurs. Sept-Apr
Every Week May-Aug

VFW Hall, 6 Veterans Place

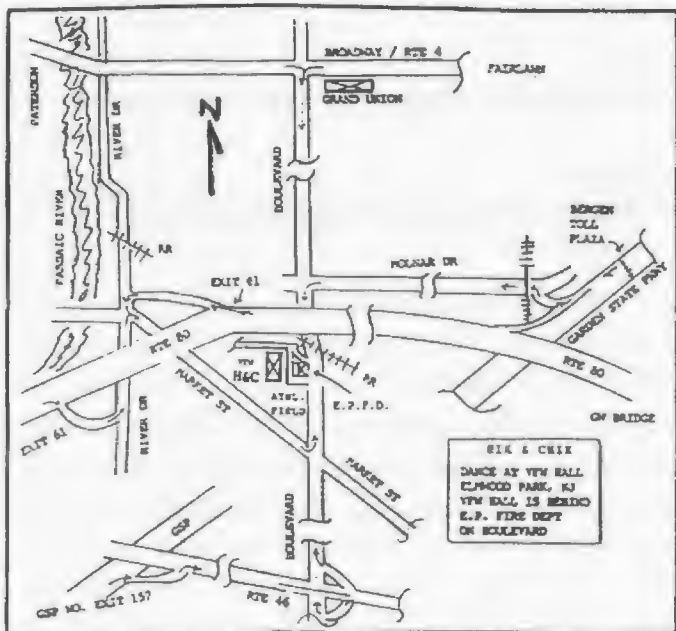

Pres: John & Connie Huettemann
1 Joseph St, Moonachie, NJ 07074

201-438-0948

Dele: John & Connie Huettemann
address as above

The date: July 6, 1986. The place: Giants Stadium. The event: the 100th Birthday of the Statue of Liberty. Participating: The Liberty Squares - over 200 strong. Choreographer: Dick Pasvolsky. Caller: Bill Heyman. Man behind the scenes: John Aquino.

Fast forward to July 11, 1996. Hix & Chix hosted a 10th Anniversary Reunion for the Liberty Squares. Thirty of the original dancers joined us for the evening. Most were in the

outfits they wore in 1986; some brought memorabilia. Two monitors played videos of the dance program.

Dick Mazziotti was our caller (he wasn't even dancing in '86). Over several week's time with the aid of video and audio tapes from 1986, Dick and eight Hix & Chix Liberty Squares dancers recreated the dance routine. They put on a demo

Please turn to page 25

Hix & Chix continued from page 24

for us and then repeated the tip so all of the other 1986 dancers could join them.

We were sorry that Dick Pasvolsky and Bill Heyman could not join the festivities. We thank John Aquino, Dick Mazziotti, and the demo team: Frank & Stasia Bremer, Rich & Georgi Flandera, John & Connie Huettemann, and Ray & AnnaLou Kuenzier, and all the other Liberty Squares dancers for a great evening.

Ad on page 23

Dick & Brenda Dexter

201-529-3372

Get all Dahled up at The Dahl House

....Then learn Country Western Dancing from "Judy May" Dahl...
11 years experience C.W. dancing
....Group or Private lessons.

MORE INFO ?
Call
(718) 981-2812

HUNTERDON FLUTTERWHEELS -- Stanton Sta., NJ Alt MS/PL

1 & 3 Fri. Sept-June

Echo Hill, Lilac Drive

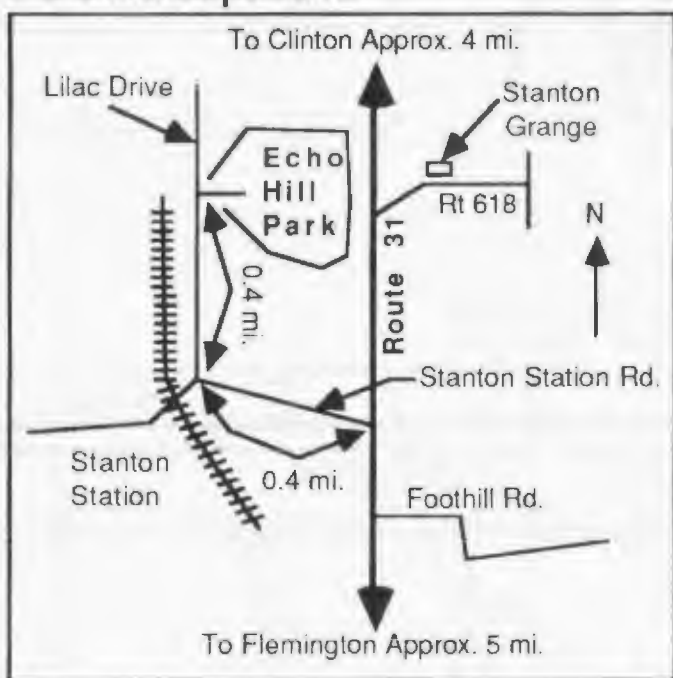

Pres: Stan & Sandy Tempsick
199 Mt. Joy Road, Milford, NJ 08848

908-995-7369

Alter. Dele: Pat & Don Elliott
81 Old York Road, Ringoes, NJ 08551

908-782-0696

Cl. Coor: Shirley & Art Richards
84 Preston Drive, Somerville, NJ

08876 908-526-4960

We finished the year with our Annual Dinner Dance and it was a big success. We even had a waiting list! Dan & Kathy Koft were our caller and cuer and the roast beef dinner was better than ever. Sandy & Stan Tempsick were installed as our Presidents for the coming year.

Flutterwheel members made most everything for the Chinese Auction, and all of it was beautiful. We have a lot of people in our club who know how to sew, crochet, do wood carving, metal working and even wine making. A big thanks go to our members who worked so hard and to all our friends and square dancers who supported us.

We kept busy during the summer with a couple of raids and a covered-dish pool party held at the home of Helen & Don Butterfoss. Helen & Don are always there to offer their pool, basement and house for anything we might need it for. Thank you Helen & Don. We're a friendly club; come visit us.

Ad on page 16

Lillian Davis

908-722-1747

'95-'96 Dance Season ONE SQUARE IS FAIR AWARD	
Cross Trail Squares	Harmony Dancers
Ironia Reelers	Lakeland Squares
Rockland Promenaders	Warren Wheelers

THE NEW FACE OF F.A.D.

" FUN AT DANCING "

SEP 1 - No Dance
Labor Day Weekend

SEP 15 - Al Jolson Night
Nick Martellacci

SEP 29 - Randy Page
(In place of OCT 6 Dance)

OCT 6 - No Dance
Go to "The Gathering"

OCT 20 - Costume Dance
Mickey McFarland

NOV 3 - Pal Johnson

NOV 17 - Pie Night
Dot Loewenstein
George - Auctioneer

DEC 1 - Don & Dot Coy

DEC 15 - Holiday Dance
Dick Mazziotti - All Students Welcomed
@ \$1.00 ea - Plus a used Square Dance
Clothing Sale

At F.A.D. we do "Substitutions"
so everyone gets to dance. We
dance MAINSTREAM with/Plus after
Tip. So join us for a fun time.

PARAMUS CONGREGATIONAL CHURCH
205 SPRING VALLEY ROAD
PARAMUS, N.J. 201-261-4166

FOR INFORMATION CALL:
DOROTHY: 201-447-4964
BRENDA/DICK: 201-529-3372



MAINSTREAM
w/ Plus After Tip
AND
Country Line
Dancing

1st & 3rd
SUNDAYS

7:00 - 9:30 PM

Proper Square
Dance attire,
and soft sole
shoes, please

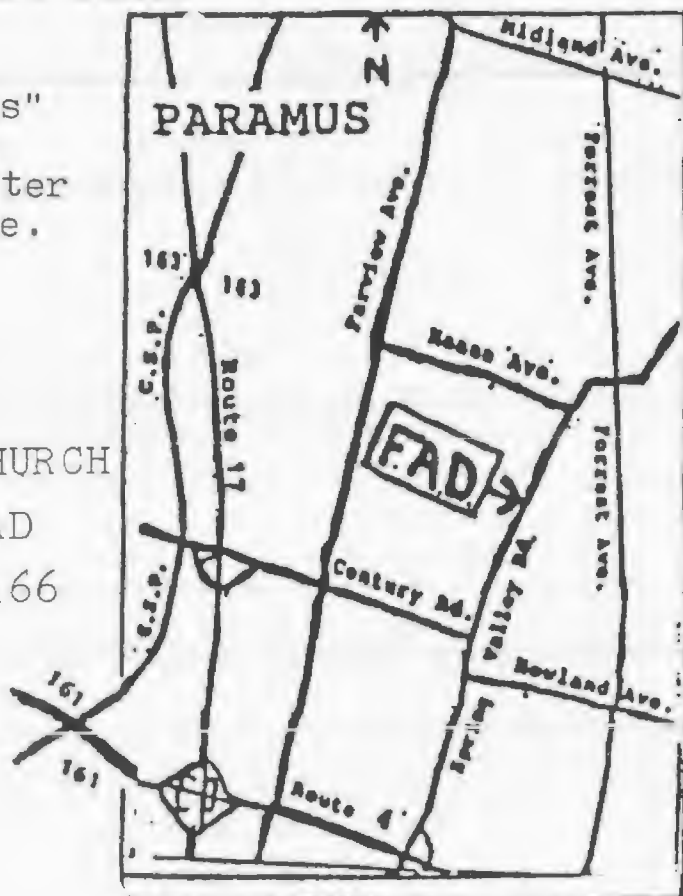

IRONIA REELERS – Randolph, NJ

PL

1 & 3 Fri. Sept-June

Ironia Elem. Sch., Dover-Chester Rd, Rt. 513

Pres: Greg & Mary Jane Roome
14 Colonial Rd, Brookside, NJ 07926
201-543-4109

Dele: Bill & Marion Pluymers
19 Wexford Dr, Mendham, NJ 07945
201-543-6747

Cl. Coor: Steve & Barbara Cook
81 Stoll St, Netcong, NJ 07857
201-347-5522

and William & Barbara Kerr
330 S. Morris St, Randolph, NJ 07869
201-989-7633

Even though the evening was hot and steamy, the dancers looked "real cool" at the season's last dance, a Pot-Luck Supper. We enjoyed full stomachs as well as a full house.

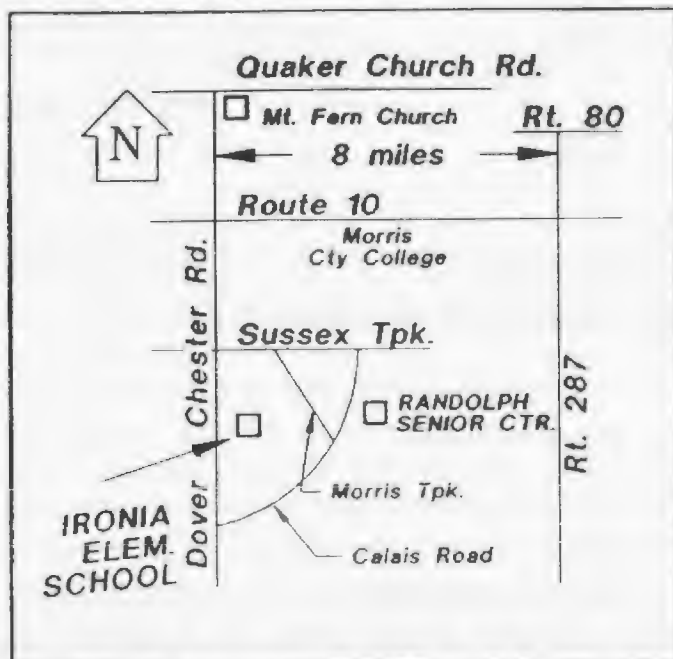

Learning from Basic to Plus, the Reelers graduated 8 new students on May 29. Also, 4 additional students advanced from Mainstream to Plus. This two-part class was taught by Wilson Hoff (his 28th year teaching) and supported by a total of 22 angels on various evenings. Congratulations and welcome to all 12 of you.

Several members attended the NSDC in San Antonio, TX in June. I hear ya'll had a great time. Kudos to our outgoing officers who will be a hard act to follow. As the new kids on the block, we are excited to begin. Let's all recruit for the fall.
Ad on page 21 Bill & Eileen Ebell 201-895-2653

CROSS TRAIL SQUARES



PLUS LEVEL

2nd & 4th Wednesdays 8:00 -10:30

* Square Dance Workshop: 7:30 - 8:00

** Round Dance Lessons: 7:30 - 8:00

Dancing at Lincoln School
Crane Street, Caldwell, N.J.

INFO: MEADOR (201) 256-5414

SOMMER (201) 857-1370

RAID: NIOSI (201) 482-5811

Sept.11 Bob Mitchell
Lois Bichler - Lines & Western

** Sept.25 Betsy Gotta
Roy Gotta - Rounds

* Oct. 9 Bob Mitchell
Dave Roberts - Rounds

** Oct. 23 John Kaltenthaler
Nick & Carol Raspa - Rounds

* Nov. 13 Bob Mitchell
Steve Bradt - Rounds

Nov. 27 NO DANCE - HAPPY THANKSGIVING

Mainstream Student Lessons

Begin October 8

Call: (201) 748-3974



Celebrate New Year's Eve with Crosstrail Squares
(Reservations required) Call Linda & Rich: (201) 243-0192

KINGS SQUARES -- Brooklyn, NY

PL

1 & 3 Sun. Sept-June

Redeemer St. John Ch., 939 83rd St.

Pres: Bernie & Pat Monsen

531 81st St, Brooklyn, NY 11209

718-745-3616

Dele: Jim & June Hamilton

7920 4th Avenue, Brooklyn, NY 11209

718-836-3848

Cl. Coor: Andy Fioriello

752 59th St, Brooklyn, NY 11220

718-439-6298

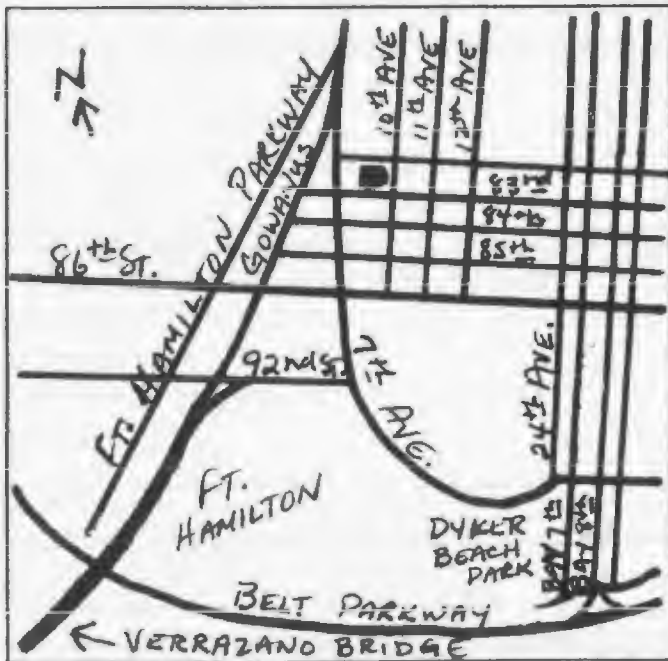

It is with great regret that we mourn the passing of two of our members, Inga Jensen and Evelyn Ninan. Inga was a former Vice President and had also served as Class Coordinator. Evelyn died after being in an accident.

On the bright side, Al Kessler has recovered nicely from his illness.

Good luck to Lynn & Larry Gold and Nancy & Jerry Vandervoort, who have moved out of Brooklyn. On a different note, Judy Callahan (a very young-looking kid) became a grandmother again. Dolores & Al Kessler's grandson had a Bar-Mitzvah in August. A picture of Harold Moshel (who?) square dancing appeared in the Long Island newspaper, *Newsday*.

We graduated 7 enthusiastic new students, including a mother and a daughter. Our Open House is Thurs., Sept. 19 with Frank Riviccio teaching. We're continuing with our Plus WS and perhaps contemplating some D.B.D. (and A-1?).
Ad on page 54 Sheila Epstein & Harold Moshel 718-332-2301

Get A-Rounds

Round Dance Club

BASIC ROUND DANCE LESSONS

Tuesdays, Starting October 8, 1996
8:00 - 10:00

Roy Gotta & Kathy Koft

North Brunswick American Legion

1015 Linwood Place, North Brunswick, NJ

\$8.00
per couple

Route 1 to New Brunswick/North Brunswick Exit. Go towards New Brunswick on Milltown Rd. At the first light, turn LEFT onto Old Georges Rd. At the next light, turn RIGHT onto Herman Rd. At the next light, turn LEFT onto Linwood Pl. Hall is three blocks on the right.

for info call Roy at 908-249-2086 or Kathy at 908 329-8507



RICHMOND DANCERS

2 & 4 Saturdays

Pre-Rounds at 8:00

Plus Squares 8:30-11:00

Date:	Caller:	Alt. Cues & CW:	Theme:
*Sept. 14	Gerry Hardy	TBA	Dessert Dance
<i>Desserts served at 7:30 PM.</i>			
Sept. 28	Randy Longobucco	TBA	
Oct. 12	Dick Pasvolsky	TBA	
Oct. 26	John Kaltenthaler	TBA	
Nov. 9	Steve Forman	TBA	
Nov. 23	Dan Koft	TBA	

*No Pre-Rounds

All Saints Episcopal Church, 2329 Victory Blvd., Staten Island, NY
 From NJ: Take Victory Blvd. Exit from the SI Expwy. Make left on Victory to Crystal Ave. Make left on Crystal. Church lot is the 2nd right.
 From Brooklyn: Take the Bradley Ave. Exit from the SI Expwy. Make right onto Bradley. Make left at Victory Blvd. to Crystal Ave. Make right on Crystal. Church lot is 2nd right.

Info: Ray O'Neill 718-987-0257; Bernie & Mary Gisonda 718-979-4798;
 Dick & Bridget Clancy 718-698-1152;
 or David & Dolores Shand 718-981-8712

Special drawing for a free admission for visitors who come across a bridge.

KITTATINNY RANGERS – Andover, NJ

Alt MS & PL

2 & 4 Fri. Sept-June

Long Pond School, 707 Limecrest Rd.

Pres: Donna Poyer & Mike Szekula
 21 Scenic Dr, Andover, NJ 07821

908-852-9285

Dele: John & Joanne Morales
 495 Stanhope Rd, Sparta, NJ 07871

201-398-7323

Cl. Coord: Kay Davis & Al Ruh
 23 Woodland Dr, Oak Ridge, NJ
 07438

201-697-7765

Our Rangers are all over the place. Kay Davis is running around Sweden and Norway; Lynn & Jim are in Hungary; Charlie & Deanne are in England. Lots are doing the USA and enjoying that great trip, too.

Two squares of Rangers raided Lakeland where Joe Fioretti was call-

ing. Nothing but rave reviews came back. And the special occasion was our Summer Picnic at Sally Mason's home and pool--full day (sunny for a change) of pure pleasure with friends. Mabel Rowett is back with us after a lengthy bout.

On the 2nd weekend in June, Mickey McFarland calls her MS weekend in the Poconos; new graduates put it on the calendar for next year. Everybody else is fine as this goes to press. Just say "thank you, God" and give a Yellowrockto your partner.

Ad on page 31

John & Ruth Seaman

201-764-7134

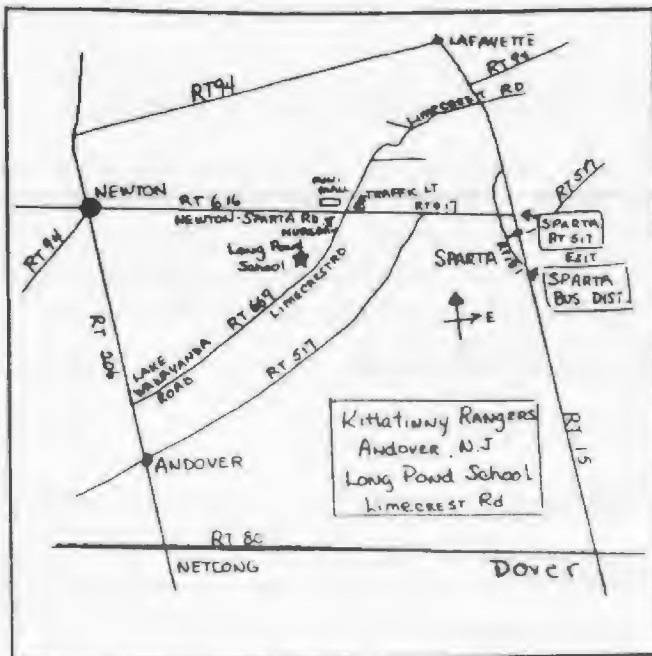

LAKELAND SQUARES – Parsippany, NJ

MS/PL tip

Every Tues. Sept-July

Temple Beth Am, 879 S. Beverwyck Rd.

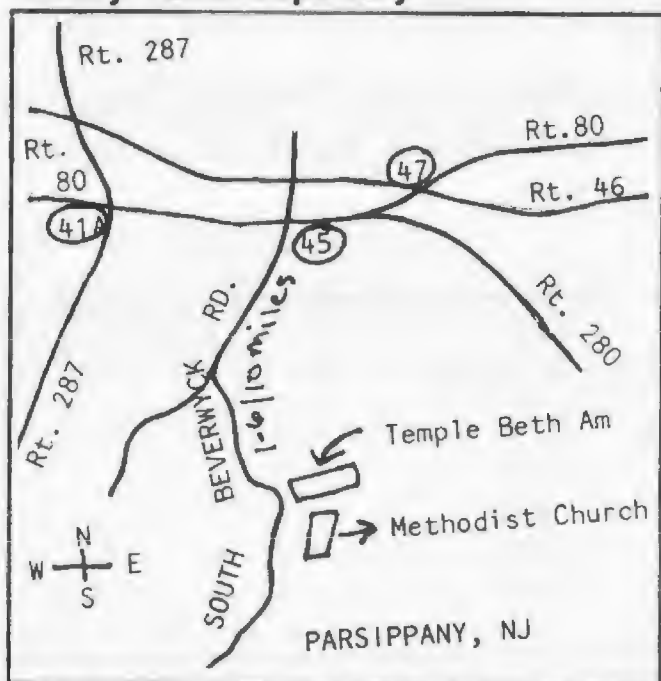

Pres: Carol Ridings
201-334-1196

Dele: Les & Lola Patterson
201-335-3541

Cl. Coor: Arlene & Tom Simansky
201-984-0009

and Harriet & Seymour Goldsman
201-731-4935

Address for all: Lakeland Sqs, PO Box 291, Lake Hiawatha, NJ 07034

We had a great time at our Pot-Luck Anniversary Dinner in May and since then have celebrated Memorial Day with a successful cake raffle, Father's Day with craziest ties, Tropical Night with leis for everyone and special festivities for these dances. On July 9,

Joe Fioretti called for 20 squares, which included three raids, Al'e'mos, Kittatinny and Spinning Wheels. We had a great dance July 16 with five local callers: Pal Johnson, Herb Conklin, Wilson Hoff, Pete Malivuk, and Bob Kozarek.

Our President, Carol Ridings, wishes to thank all of the outgoing Board members for their help and interest this past year and welcomes all the new Board members. She is looking forward to keeping the club strong and successful with their input. We've changed the day for our fall classes to **MONDAY**. No dancing for us in August. See you in September.

Ad on page 47

Dorothy Fleming

201-267-4756

ROCKYTOPS



PLUS LEVEL DANCING WITH A-1 AFTERTIP

*First Friday of Month -- Rounds at 8:00pm -- Squares from 8:30 to 11pm
United Methodist Church -- John Street at Franklin Avenue -- Pearl River, New York*

Friday, October 4	RALPH STAPENELL	PA
Friday, November 1	BOB LABOUNTY	NY
Friday, December 6	LOU FLEGO	NY
Friday, January 3	ROY LEBER	PA
Friday, February 7	TODD FELLEGY *	CT

ROUNDS BY NICK AND CAROLE RASPA

* February 7 dance will be held at Old Stone Church Education Center, Upper Saddle River, NJ

For Further Information, Please Call:

Eileen & Larry
Sandy & Art

(914) 362-1924
(914) 352-7631

Roz & Ron
Beverly & Marty

(201) 664-9356
(201) 391-3592

LEISURE SQUARES – E. Stroudsburg, PA
1 & 3 Sat. Oct-Dec & Mar-May

Alt. MS/PL
J.M. Hill School, East Broad St.

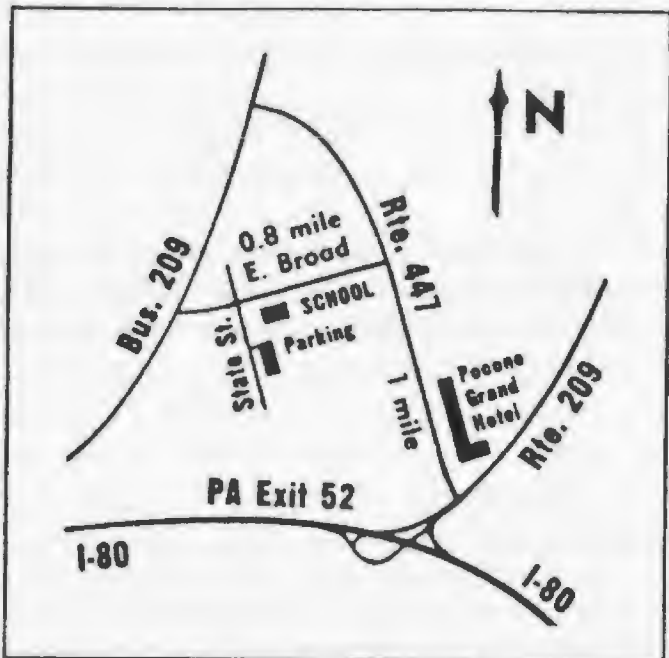

Pres: Tom Moss
65 Geronimo Road, Effort, PA 18330
717-620-1592

Dele: TBA

Contrary to rumors, we have received word from Tom Moss that they plan to keep Leisure Squares alive. They have put a slate of officers together for the '96-'97 dance season.

Ad on page 55

KITTATINNY RANGERS

2 & 4 Fridays (7:30 PM)
Alternating MS and Plus

Long Pond School
Andover, NJ

SEPT 27
OCT 11
OCT 25
NOV 8
NOV 22

MICKEY McFARLAND
ANDY WOERNER
JIM SNYDER "HALLOWEEN"
NICK MARTELLACCI
MICKEY McFARLAND

INFO: DONNA POYER - 908-852-9285

MOTIV8ORS -- Paramus, NJ

A-2 /C-1 tip

1, 3 & some 5 Sun. Sept-June
Every Sun. Jul & Aug

Jewish Community Center
Midland Ave. at Spring Valley Rd.

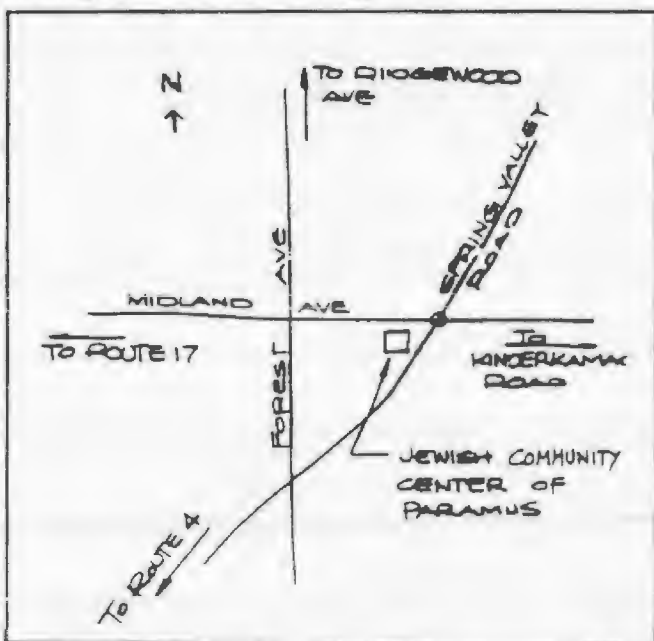

Pres: Grace & Steve Weinstein
8 Brayton St, Englewood, NJ 07631
201-568-6418

Dele: Bernie & Sandy Beck
657 Prospect St, Glen Rock, NJ 07452
201-447-0538

The probability of someone watching you is directly proportional to the stupidity of your actions.

MOUNTAIN SQUARES -- Whippany, NJ

A-2

1, 3, & 5 Wed. Sept-June

First Presbyterian Church, 494 Route 10

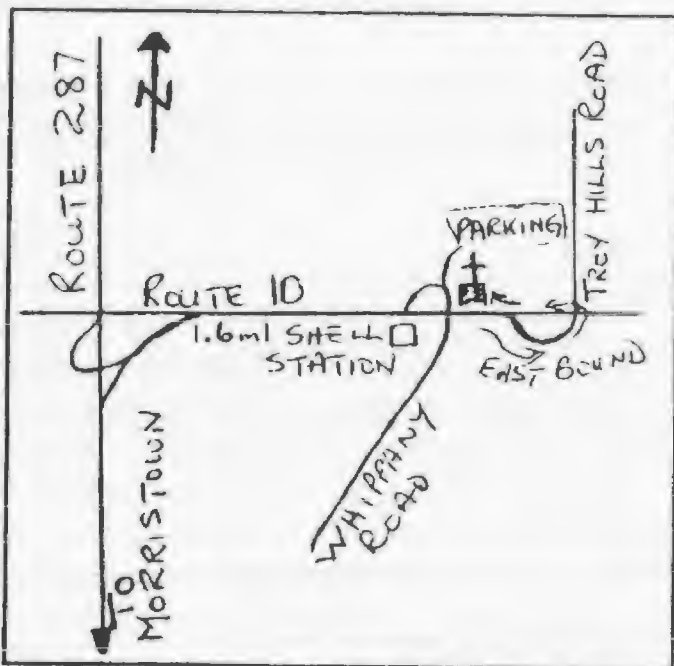

Pres: William & Hilda Groth
45 Brookfield Rd., Upper Montclair, NJ
07043 201-746-0656

Dele: Walt & Mildred Angerer
22 Park Terr., West Caldwell, NJ
07006 201-226-5837

If you are ready for the exercise and happy faces of A-2 square dancers, it's only a short drive to us where our dedicated caller and friend, Joe Landi, steers us through our A-2 antics. He's "here to help" if we should mess up!

Thanks to Joe Landi and our dedicated officers and committee members, we had a good season last year. Also, our membership has increased as new A-2ers have found

their way: Joe & Eileen Rizzo and Greg & Mary Jane Roome have joined the roster with Richard & Alberta Stogniew and Joe & Mary Rose Womer.

Cheers go up with the return of our lovable, loyal couples: Mildred & Walt Angerer and Mary & Curt Hoelle, after a summer of recuperation from Walt's and Curt's important surgery. Now's the time to put on those dancing shoes, turn off that noisy air-conditioner, and join us at our "base camp." You don't have to climb a mountain! All who dance A-2 are welcome. Watch for our A-1 specials.

Ad on page 35

Isabelle & Doug McCabe

201-226-3955

COUNTRY PROMENADERS



Stelton Community Center
Plainfield Ave., Edison, NJ
Two blocks from Route 27
10 min from Tpk, GSP, 287



Hall Phone (908) 287-5678
Jan & Louis (908) 577-9413
Terry & George (908) 754-1425
Inclement weather: call first

JOIN US FOR FUN DANCING & GREAT REFRESHMENTS

2nd & 4th SATURDAYS - NO BOOTS or HIGH-HEELED SHOES
Early Rounds: Steve Bradt 7:30 - Plus Level Squares 8:00 - 10:30

- | | |
|----------|---|
| Sept. 28 | WILL LARSEN (CT) Opening Dance! |
| Oct. 12 | ED FOOTE (PA) |
| Oct. 26 | JOHN CARLTON (KY) HALLOWEEN DANCE
COSTUMES WELCOME |
| Nov. 9 | JOHN KALTENTHALER - 44th Anniversary Dance! |
| Nov. 23 | JIM SNYDER - Happy Thanksgiving! |
| Dec. 14 | DREW SCEARCE (VA) COOKIES (w/recipes) NITE |

ADVANCED OR DBD PLUS TIP AT END OF DANCE!

Y SQUARES

2 & 4 Fridays

Carl Kumpf School, Mildred Terrace, Clark, NJ

7:30-8:00 p.m. Rounds

8:00-10:30 p.m. Squares & Rounds

Soft-soled shoes required.

SEPT 13th	OPEN HOUSE	
	Caller: Brian Fugere	Cuer: Karen Kushla
SEPT 27th	WELCOME BACK	
	Caller: Brian Fugere	Cuer: Karen Kushla
OCT 11th	APPLE FESTIVAL	
	Caller: Brian Fugere	Cuer: Karen Kushla
OCT 25th	HALLOWEEN HOE DOWN	
	Caller: Dan Koft	Cuer: Kathy Koft

Directions to Carl Kumpf School: GSP exit 135; west on Central Ave. At first light turn left on Raritan Rd; at third light turn left on Madison Hill Rd. Third Street on the right is Mildred Terr. Go a half block to school entrance on left.

Information: The Magnanis (908) 756-0268
 Jean Koenig (908) 276-8049 Leave message
 Hall Phone (908) 574-8354

OCEAN WAVES – Staten Island, NY

MS/PL tip

1 & 3 Fri. Sept-June

Christ United Meth. Ch., 1890 Forest Ave.

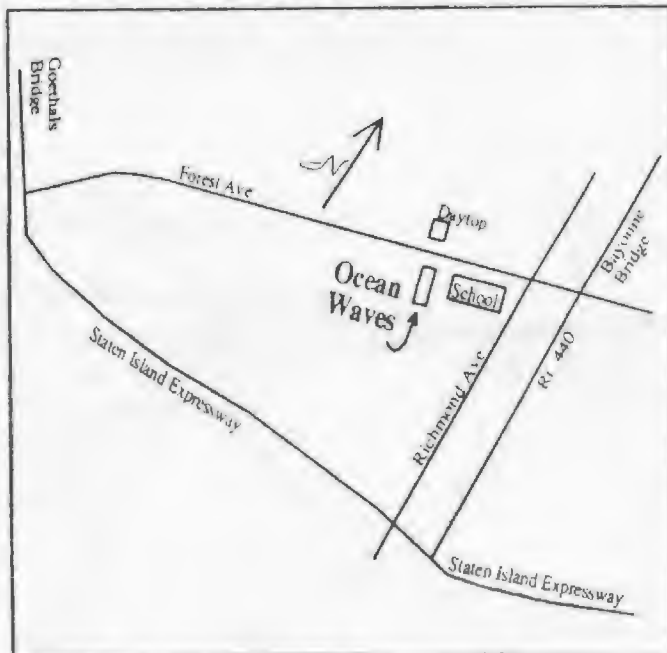

Pres: Eileen Gilder
 2022-79th Street, Brooklyn, NY 11214
 718-259-1292

Dele: Harry Rodriguez
 175 Campbell Ave, Staten Island, NY
 10310 718-816-8533

Ocean Waves, a MS club in S. Is., has been sailing off on lots of "fun raids" this past summer. Clubs visited include: Tenafly Squares, Bee Sharps, Lakeland Squares, D & R Squares and other, as well as the NNJSDA dances.

We welcome back our new President, Eileen Gilder, Edmonton, Alberta, where she square danced at the 10th National Canadian Square & Round Dance Convention. She's also

due to become a first-time grandmother in October. Speaking of new grandparents, Florence & Jerry Weinstock just joined that group via their son Aaron's baby daughter. More good news--Roz Stendig's son, Paul, will be married in September. Helaine & Arthur Schwartz are very proud of their son, Mitchell, who made the Dean's List at Northwestern University.

Our Past President, Judie Dahl, and her exhibition team entertained at the Sussex County Fair along with Ocean Waves members Lisa Oshins, Harry Rodriguez, and Al Burchsted. Students and new graduates are always welcome.

Ad on page 15

Maria Mazzaresse

718-984-0826



Harmony Dancers

Plus Dancing

1st & 3rd Saturdays

8:00 to 10:30
Pre-Rounds 7:30



CHISHOLM SCHOOL, SO. SPRINGFIELD AVE AT SHUNPIKE, SPRINGFIELD, NJ

September 21 <i>"Welcome Back"</i>	Al Kaesler	Al Spinks
October 5 (Advanced Tip @ 10:30)	John Kaltenthaler	Al Spinks
October 19 <i>"Pumpkin Festival"</i>	Will Larsen	Dave Roberts
November 2 (Advanced Tip @ 10:30)	John Kaltenthaler	Karen Kushla
November 16 <i>"Turkey Trot"</i>	Brian Fugere	Al Spinks
December 7 (Advanced Tip @ 10:30)	John Kaltenthaler	Steve Bradt
December 21 <i>"Holiday Dance"</i>	Ed Foote	Karen Kushla

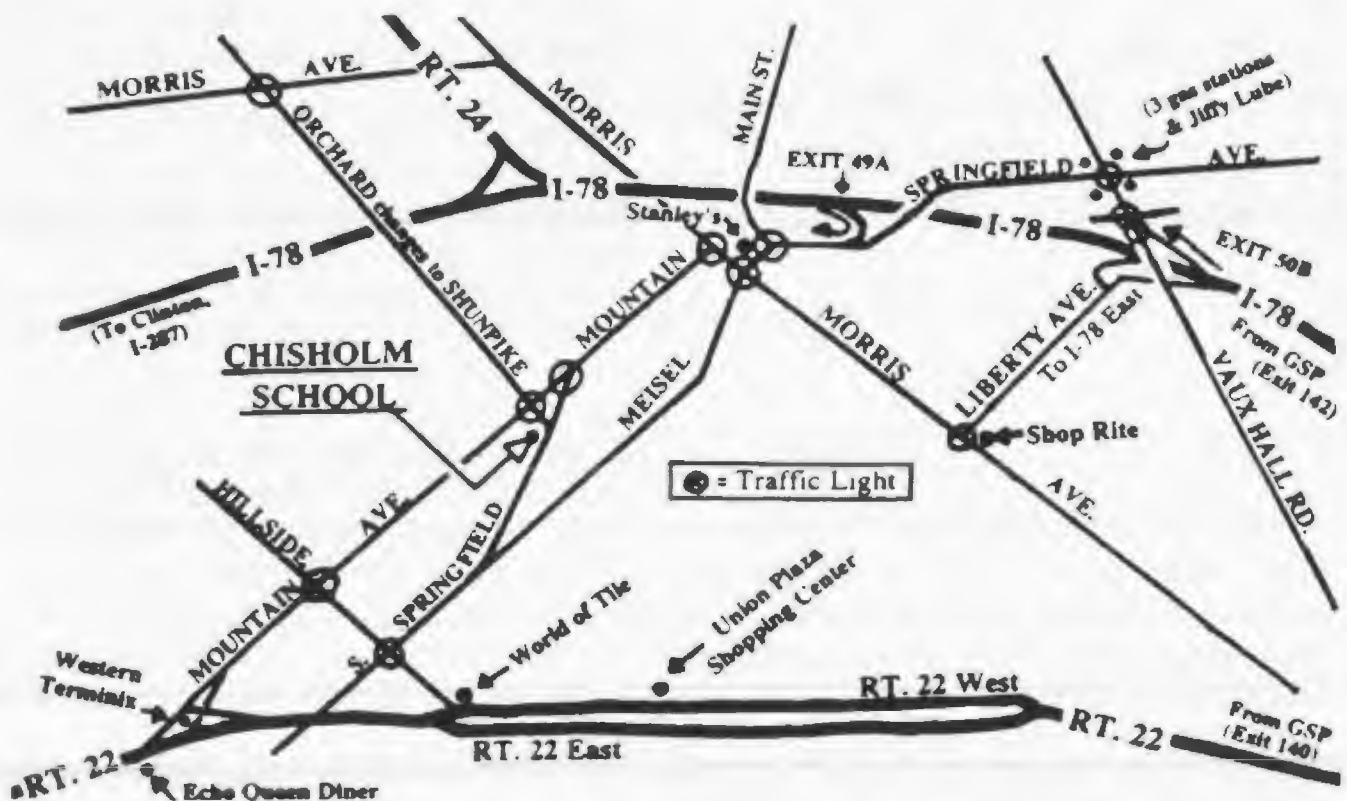

Info: Wayne/Kay → 908-396-8286
Soft Soled Shoes, Please

Corinne/Leo → 201-379-3901

Jude/Roger → 908-322-1879

Chisholm Hall Phone: 201-376-9822

RICHMOND DANCERS – Staten Island, NY

PL

2 & 4 Sat. Sept-June

All Saints Church, 2329 Victory Blvd.

Interim Pres: Ray O'Neill
718-987-0257

Co-Presidents for election 9/14/96:

Pres: Bernard & Mary Gisonda
161 Hull Ave, Staten Island, NY 10306
718-979-4798

and Dick & Bridget Clancy
1289 Melba St, Staten Island, NY
10314 718-698-1152

and David & Dolores Shand
20 Cliff St, Staten Island, NY 10305
718-981-8712

Dele: Al & Dot Rehorn
143 Lamport Blvd., Staten Island, NY
10305 718-447-5262

Our annual meeting of our 44th year ended in a disappointment. Sad to

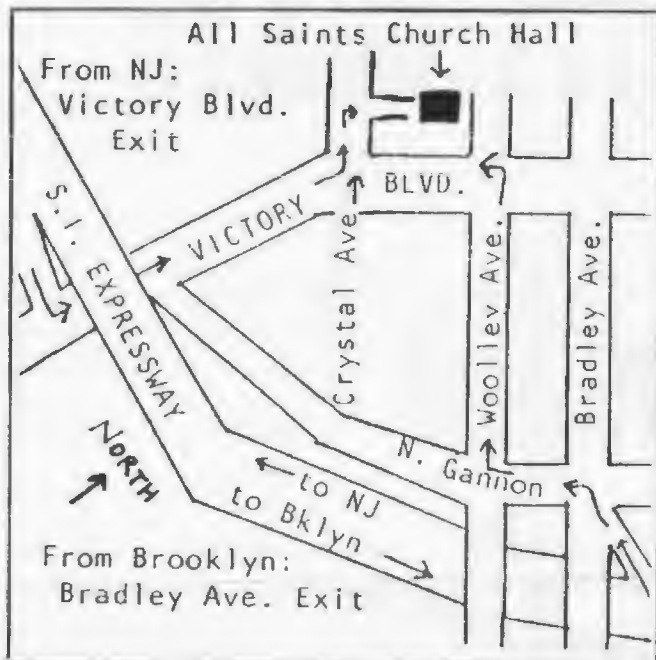

say, there was such a lack of interest from all members to step forward to keep our organization strong. Fortunately, Ray O'Neill offered to act as interim President until the September meeting when a permanent slate could be voted on.

We, who have been privileged to serve as Presidents over the past 44 years ask, "Why?" It is a responsibility and a commitment, that's true, but the rewards are many and the helping hands are always ready for all. Try it and see. Contact Bernie & Mary Gisonda at 979-4798 to offer your help, suggestions and encouragement as they try to keep Richmond Dancers afloat.

We offer our condolences to Marcia Rubenstein on the death of her mother and speedy get well wishes to her husband, Sandy. Jim Branigan could use some kind prayers and thoughts after his recent heart surgery but, as with many times before, we know you can't keep that good man down.

Last time we wrote that Pete & Joan Yuskevich had a baker's dozen of grandchildren. This month be sure to ask to see pictures of their new grand arrivals - triplets, 2 boys and a girl. Congratulations to all!

Vacations are in full swing and they're great to discuss. Just ask the Delaneys or us about our recent Scandinavian Holiday.

As we begin our 45th dance season, let's take a minute to thank those who, in the past, stepped forward to answer the call and those who now, when so needed, will take on the responsibility and try. Square dancing is fun but we all must pitch in to make it so.

Ad on page 29

Grace & Lou Motola

718-447-1531

You Don't Have to Climb a Mountain to Find Good Advanced Dancing!



MOUNTAIN SQUARES

Club Caller - Joe Landi

1st & 3rd Wednesdays, beginning Sept 18
Level A-2 7:45 - 10:15 PM

A-1 Special – October 30

John Kaltenthaler 7:45 - 10:15 PM

First Presbyterian Church, 494 Route 10 West, Whippany, NJ

Info: Groth (201) 746-0656; Beebe (201) 335-0127; McCabe (201) 226-3955

BOLOS-N-PETTICOATS

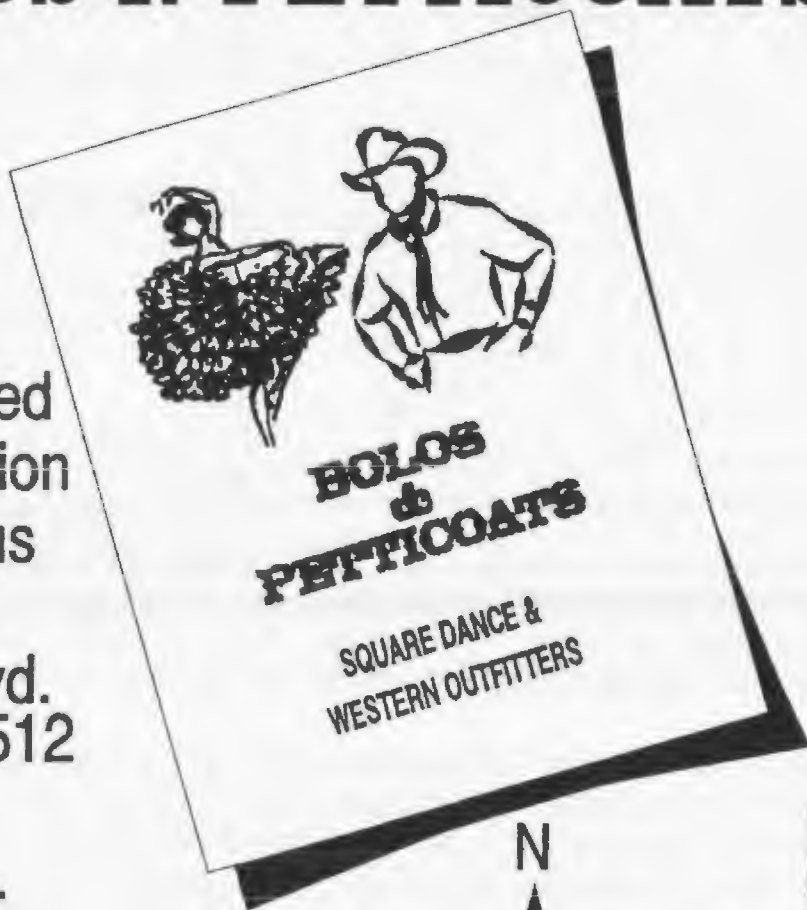

We have moved
to a new location
You can find us
at
192 Union Blvd.
Totowa, NJ 07512

Business Hours:
by appointment only

(201) 904-0424

WE ACCEPT CASH OR CHECKS - NO CREDIT CARDS

DIRECTIONS:

Traveling Route 80 West - exit 55B (Union Blvd, Totowa).

Traveling Route 80 East - exit 53 to Rt 46 East to Union Blvd, Totowa.

Follow Union Boulevard (north) about 1 1/2 miles to #192 on the right. Park in the rear.

WILLOWBROOK MALL

We carry Mens & Ladies Western

Shirts, Peasant Blouses & Skirts

2 piece matching sets, Petticoats

and a full selection of Square Dance Wear

*Brenda
&
Frank*

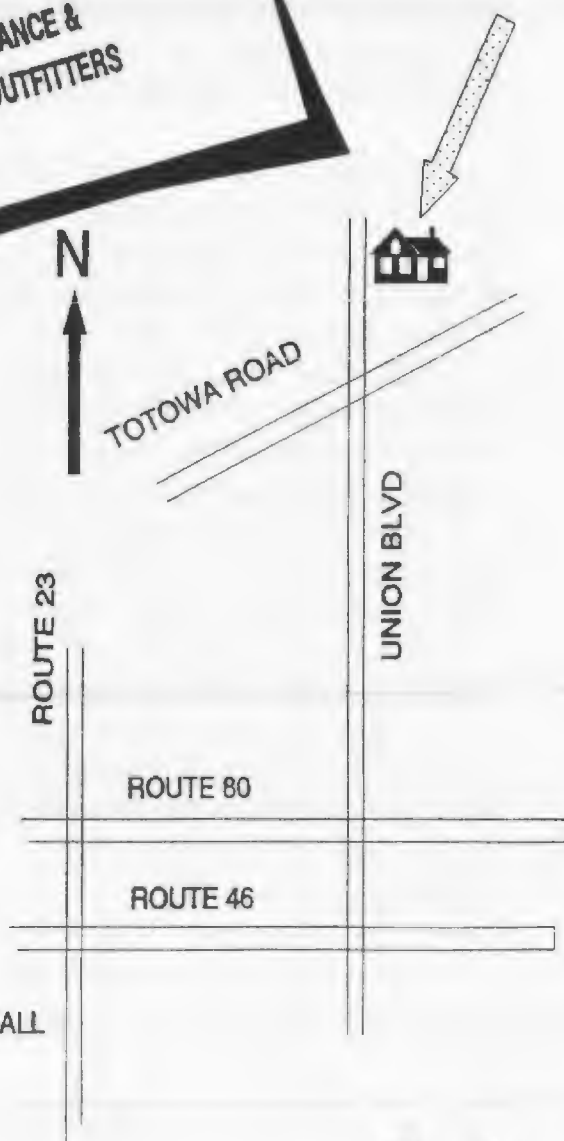

Come in and checkout the NEW ARRIVALS & DISCOUNTS!

**NORTHERN NEW JERSEY SQUARE
DANCERS ASSOCIATION**

22th Annual

MINI-FESTIVAL

SUNDAY, NOVEMBER 10, 1996
2:00 to 9:00 p.m.

Bridgewater-Raritan Regional Middle School
(formerly Bridgewater-Raritan Regional High School-East)
Bridgewater, NJ

JERRY STOREY (TX)
MIKE JACOBS (VA) **MARK FRANKS (NJ)**
RON & REE RUMBLE (NJ)

Limited to
90 Squares

*****3 Halls*****

Mainstream thru C-1
Bring box supper

No cooking or warming devices
Round Dance demonstration

Bolos & Petticoats Square Dance Shop

See Map and Directions
on page 69

Info: John & Joan Berg 201-697-5208 or Sal & Mary Alessi 201-256-1647
Registrars: Norman & Audrey Bolin 201-729-9327

Proper Square Dance attire required. Soft-Soled Shoes --No Boots or High-Heeled Shoes. Bring Club Banners. Coffee & Cold Beverages Provided.

Ribbons are available from your club Delegate or any NNJSDA Officer.
Fill out the form; give it to your Delegate or an Officer; or mail form and check to:
Norman & Audrey Bolin, 585 West Shore Trail, Sparta, NJ 07871

*Note: Ribbons will be available at the door ONLY if not sold out.
Please call. No refunds after November 1, 1996*

Give to Delegate/Officer or mail to: Norm & Audrey Bolin, 585 West Shore Trail, Sparta, NJ 07871

Name(s) _____ Club _____

Address _____ City _____

State _____ Zip _____ Phone (____) _____

Advanced Remittance \$8.00 per person \$ _____ \$10.00/person at the door
1st time badge only 1996 \$2.00 each \$ _____ ...IF NOT SOLD OUT!!!
1996 bar \$.75 each \$ _____
TOTAL \$ _____

Please make check payable to NNJSDA Mini-Festival.

ROCKLAND PROMENADERS – Chestnut Ridge, NY MS/+ tip
2nd Sun. All Year Green Meadow Waldorf Sch, Hungry Hollow Rd.

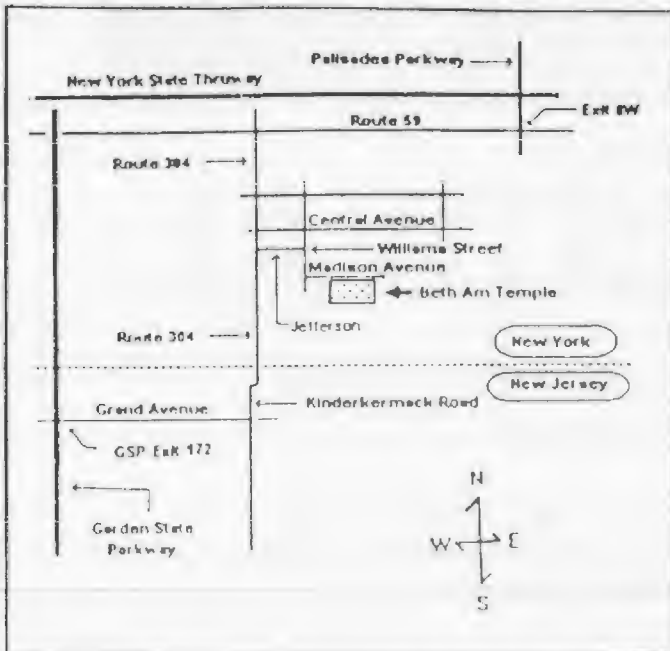

Pres: Lenny & Carol Steinfeld
 41 Lyncrest Dr, Monsey, NY 10952

914-354-4374

and Tom & Bonnie Silk
 235 Betsy Ross Dr, Orangeburg, NY
 10962

914-365-0525

Dele: Rich & Lucille Behrens
 63 S. Lilburn Dr., Garnersville, NY
 10923

914-947-2867

A new season is underway! We welcome back our members and graduates. It was great to see so many dancing this summer. Can't wait to hear about all the great vacation spots that were visited and the fun you had dancing while there, as we're sure you did. With the heat making it

impossible to dance, we are happy to see September and hopefully some comfortable weather.

Our new Board members and committee volunteers promise a lot of excitement for this new year--great callers and a lot of fun! We can't wait to see everyone again and look forward to meeting your new dancers.

Ad on page 62

Jo-Ann Maggio

914-623-5889

HI TAW TWIRLERS

1996/1997 PLUS DANCES - TUESDAYS

A2 AFTER-TIP

NEW MILFORD MIDDLE SCHOOL
 ROSLYN AVE., NEW MILFORD, NJ

PUBLIC PHONE: (201)261-9881

SEPTEMBER

17 JOHN KALTENTHALER

OCTOBER

1 KEN RITUCCI

15 JOHN KALTENTHALER

29 HOWARD RICHMAN

NOVEMBER

5 JOHN KALTENTHALER

19 TODD FELLEGY

DECEMBER

3 JOHN KALTENTHALER

17 RANDY PAGE

JANUARY

7 JOHN KALTENTHALER

21 BRIAN FUGERE

FEBRUARY

4 JIM SNYDER

25 DON CROSBY

MARCH

4 JOHN KALTENTHALER

18 BRIAN FUGERE

APRIL

1 KEN RITUCCI

15 JOHN KALTENTHALER

29 HOWARD RICHMAN

MAY

6 JOHN KALTENTHALER

20 RANDY PAGE

JUNE

3 LOU FLEGO

Rounds...7:30 Cuer: Nick Raspa

Squares...7:45:10:00

JUDY
 Info: (201)391-7961

JILL
 (914)623-8926

ADVANCED LESSONS

Caller/Teacher

BETSY GOTTA

Wednesdays Starting October 9, 1996

8 - 10:15 pm

\$7.00 / couple

Trinity Episcopal Church, Front St., Red Bank, NJ

FROM GS PARKWAY: - Exit the GSP at exit 109 and take 520 east (Newman Springs Rd.). Go to Rt. 35 (Broad St., "T" intersection) and turn left. Go over the railroad tracks and bear left onto Rt. 35 North. This is also Maple Ave. Go thru 2 lights and turn right at the first street past the second light. This is White St. The back entrance to the church will be 1/2 block on your left. Park in the municipal lot on the right.

for info: call 908 - 249 - 2086

ROCKYTOPS of ROCKLAND – Pearl River, NY PL/A-1 tip

1st Fri. Oct-June

United Meth. Ch. of Pearl River, John St. at Franklin

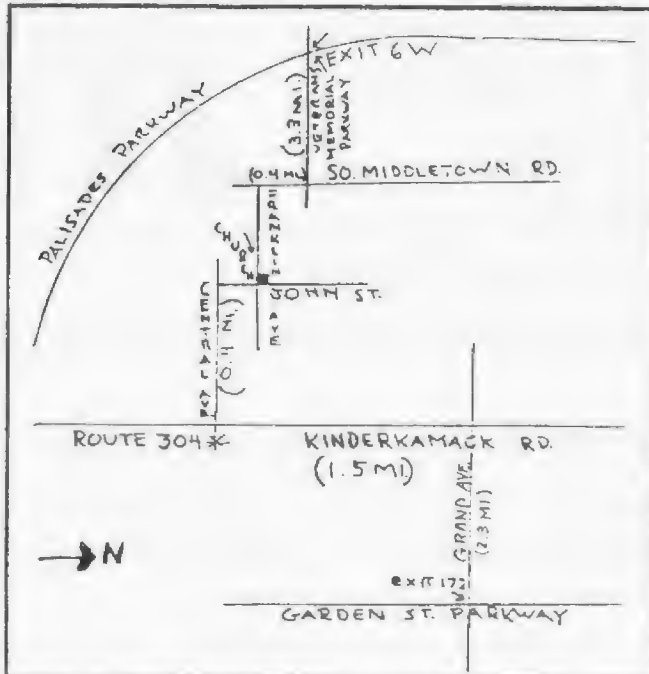

Pres: Larry & Eileen Landon
21 Greenridge Way, Spring Valley, NY
10977 914-362-1924

Dele: Doug & Pat Neutzman
25 Wainwright Ave, Closter, NJ
07624 201-784-9120

Congratulations to all the recent graduates. Attend as many dances as possible. Rockytops has just completed another successful year thanks to the leadership of Presidents Larry & Eileen Landon. They did an outstanding job and have agreed to remain as Presidents for another year. Our spring dances were well attended, thanks to Randy Page in April, Brian Fugere in May, Tim Crawford

from Canada in June, and smooth rounds as always from Nick & Carole Raspa.

Micky & Patsy Lisak recently returned from a 5-week auto trip out west. They had a great time. Quite a few couples attended the Long Island Jubilee and Hunt Valley, Maryland. At least 5 couples attended the National Advanced & Challenge Convention in Virginia Beach and a good time was had by all.

Join us for an evening of fun and friends with top regional callers. Our Pearl River location is 20 min. from the intersection of GSP and Rt. 80 Saddle Brook and 15 min. from the Tappen Zee Bridge.

Ad on page 30

Maria & Roger Hoernlein

201-384-0334

MYSTIC ADVENTURE

FABULOUS PLUS LEVEL WEEKEND

NOVEMBER 15, 16, 17, 1996

with

**RED
BATES**

**CLIFF
BRODEUR**

Rounds by
Ralph & Joan Collipi
at the

Best Western Sovereign Hotel
Mystic, Connecticut



\$264 per couple includes:

2 Nights Lodging

5 Complete Meals

5 Square Dance Sessions

A-1 Star Tips / After Party

Round Dance Workshop

Hardwood Floor

Indoor Pool

Square Dance Apparel Shop



\$50 PER COUPLE DEPOSIT TO: RED BATES

May-Oct: 82 Regecy Park Dr., Agawam, MA 01001 (413) 786-0212

Oct-May: PO Box 7704, North Port, FL 34287 (941) 423-7143

MYSTIC ADVENTURE – NOV. 15-17, 1996

GS

Name _____
LAST HIS HERS

Street _____

City _____ State _____ Zip _____ Phone _____

Room Near _____ Requests _____

RUTGERS PROMENADERS – North Brunswick, NJ
2 & 4 Thurs. Sept-May

MS
American Legion, 1015 Linwood Pl.

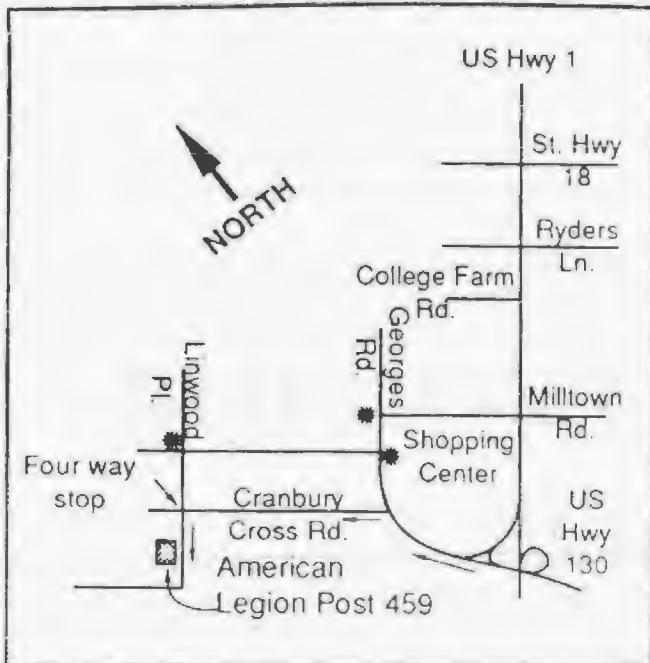

Pres.: Ray Schmidt
 64B Burton Ave, South River, NJ
 08882 908-613-9505

Dele.: Nick & Dot Petroulas
 215 Central Ave, Hasbrouck Hghts, NJ
 07604 201-288-3968

Cl. Coor.: Jeff Platania
 30 Buttonwood Dr, Somerset, NJ
 08873 908-249-0916

Ad on page 6

FRIENDLY SQUARES

MAINSTREAM DANCING, Plus W/S

1st & 3rd Wed. Sept-May

Livingston Rec. Center

Take Route I-280 exit 5A

At 5th light, turn right

More info, Linda (201) 243-0192

NEW DANCERS WELCOME

SEE SAW SQUARES -- Upper Saddle River, NJ
PL - 3 Sat. Oct-June

MS/PL
Old Stone Ch. Ed. Ctr, 500 East Saddle River Rd.

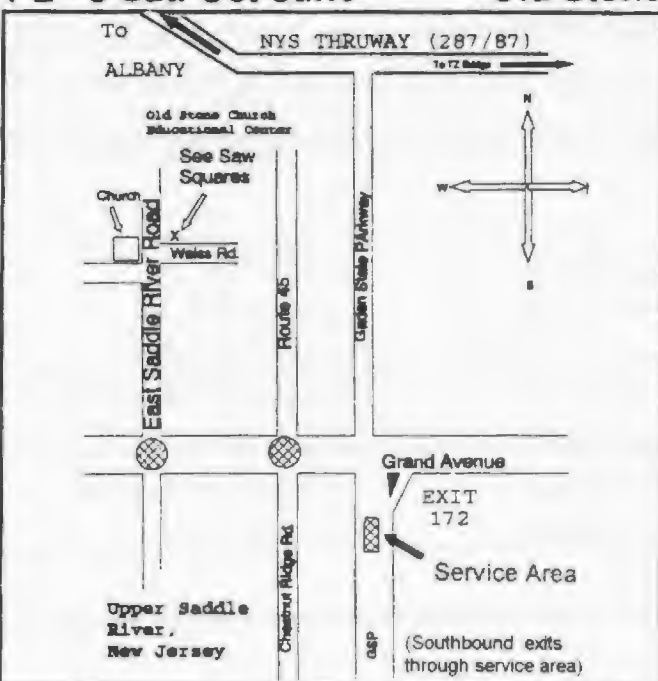

Pres: Joan Schierlitz
 22 Sierra Vista Ln, Valley Cottage, NY
 10989 914-353-2987
 and Bob & Hillela Ward
 914-352-0881

Dele: Norman & Phyllis Forgash
 16 Sands Point Road, Monsey, NY
 10952 914-356-3207

See Saw Squares wound up a fun-filled '95-'96 season with Gerry & Chuck Hardy calling for our MS Special on June 1 and John Kaltenthaler calling for our Ice Cream Social on June 15. Our very active raid season wound up with raids to Circle Eights, Hix & Chix, FAD, Tenafly Squares, Cross Trail Squares, Lake-

land Squares, Belles & Beaux, and Spinning Wheels.

Lyn & Bob Terry are delighted to announce the birth of two new grandsons in June, Jackson Terry Ganem and Ian Robert Terry.

See Saw Squares welcome visitors, both couples and singles.

Ad on page 57

Lyn & Bob Terry

201-327-9274

VALLEY SQUARES

1 st & 3 rd Thursdays
8:00 to 10:30
PLUS Program
Soft Soled Shoes Please

WE HAVE LOST OUR HALL!!!

AT PRESS TIME, WE WERE STILL WITHOUT
A NEW HOME.

Please call us to find out our new location.

Round Dance Workshop
7:30 to 8:00



Date	Caller	Cuer	Theme
Sept. 19	Pete Diven	Dance cancelled!	Grand Opening Special
Oct. 3	Howard Richman	Steve Bradt	Raid Chair Free!
Oct 17	Randy Page	Steve Bradt	Masked Ball Masks Provided
Nov. 7	Roy Leber	Steve Bradt	Presidents' Night
Nov. 21	Don Coy	Steve Bradt	Turkey Shoot
Dec. 5	Dick Mazziotti	Steve Bradt	1st Night Hanukkah
Dec. 19	Joe Landi	Steve Bradt	Holiday Dance

Info: Bud & Fran (908)272-6316

Barry & Norma (908)464-1739

Ted (908)756-2552

SPINNING WHEELS of WAYNE -- Wayne, NJ MS/PL tip/CW

Every Mon. Sept-June

Wayne Civic Center, Hamburg Tpk & Church Ln.

2 & 4 Mon. July-Aug

Temple Emanuel, Rt. 202, Oakland

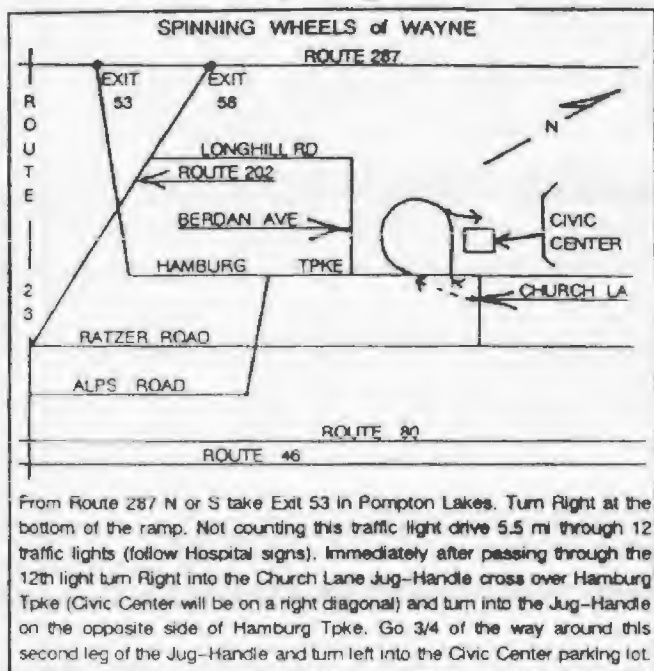

Pres: Dolores Gesumaria
65 Loyola Place, Oakland, NJ 07436

201-337-8365

Dele: John & Barbara O'Hare
18 Gibraltar Terr, Hawthorne, NJ 07506

201-427-4745

Cl. Coor: Nora & Tom Burke
24 Chestnut Dr, Wayne, NJ 07470

201-694-1750

Our year-end activities kept us dancing and partying quite often. On May 27, we marched in the Wayne Memorial Day Parade and then we were off to Dolores' house for a BBQ with her family. On June 1, we danced and enjoyed a BBQ at Howie & Kathie Steentras' church with Bob Mitchell as

caller. On June 3, we held our Graduation Dance and where we graduated 20 students. The NNJSDA was represented by Presidents, John & Joan Berg. Our graduates presented lovely gifts to our caller, Bob Robinson and helper callers, George Haberberger and Dolores. One highlights of the evening was the dance our graduates did with the aid of shoeboxes on their feet. A great time for all!

On June 14, we did a demo at Alps Manor Nursing Home with two squares. The residents were so enthusiastic we kept dancing and socializing until it was time for them to have dinner. On June 19, we had our end-of-the-year party on our lesson night. It was catered by Dolores' mom, who at 87 is still the best cook around. Our last dance of the season at the non air-conditioned Civic Center on June 24, one of the hottest nights of the year, was attended and enjoyed by 8 squares. We danced twice a month during the summer at Temple in Oakland.

On June 29, my children hosted a surprise retirement party for me. I was thrilled and awed that they could pull something like this over on me. There were over 125 people in attendance, many of them square dancers, and I felt like a queen. I may have retired from teaching school after 40 years but now I can concentrate on teaching square and country western dancing.

Our '96-'97 season starts the 2nd Monday in September with a Free Appreciation Dance and our Free Open House will be on Monday, September 30. Our lessons start on Wednesday, October 2 in Oakland at Valley Middle School.

Ad on page 9

Dolores Gesumaria

201-337-8365

BUCKS-TRENTON DISTRICT
Homecoming Dance

Sunday, October 27, 1996

Nottingham Ballroom
200 Mercer Street
Hamilton Square, NJ

WATCH FOR FLIERS!

CRAIG ROWE

Hagerstown, MD

Squares

Plus 2x2 2:00-4:30

A-2 Tip: 4:30

RON RUMBLE

Rounds

Pre-rounds 1:30

Lechner 609-924-7545
Lindbloom 609-882-3949

If the world seems cold to you, kindle fires to warm it.

Lucy Larcom

info
908-249-2086

GOTTA DANCE With Roy & Betsy Gotta

1st 3rd & 5th Thursdays - **BACtracks** (A2 w/rounds)
Trinity Episcopal Church, Red Bank, NJ 8pm

2nd & 4th Sundays (mostly) - **tagBACs** (C1 w/rounds)
ACFC, Hankins Rd, West Windsor, NJ 7:30

2nd & 4th Thursdays - **Rutgers Prom.** (MSw/Rnds)
Amer. Legion No. Brunswick, NJ 8pm (w/Kofts)

All Mondays (no 5ths) - **Get A Rounds** (Ph 3/4 Rnds)
Amer. Legion No. Brunswick, NJ 7:45 (w/Kathy Koft)

Occasional Tuesdays - **C3A** (C3A)
Amer. Legion, No. Brunswick, NJ 8:00 pm

You
Gotta
Believe

STATEN SQUARE SET – Staten Island, NY

PL

1 & 3 Sat. Oct-June

St. Alban's Church, 76 St. Alban's Pl.

Pres: Edward & Evelyn Hochuli
30 Woodland Ave, Staten Island, NY
10308 718-984-8770

Dele: Joe & Eleanor DiGiacomo
301 Retford Ave, Staten Island, NY
10312 718-948-6740

We hope last year you were out dancing and having a good time because that's what square dancing is all about. We ended our dance season with a delicious catered dinner and dance with Marion Pearce calling. We have the same slate of officers except Pete & I will be taking over the spot of Treasurers as the Malkins are away. Thanks go out to them for their service to our club. One of the

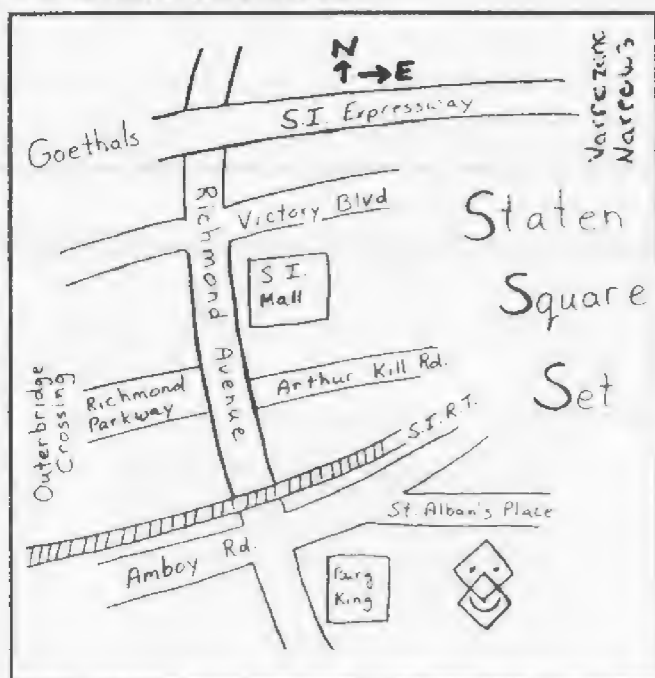

highlights of our dinner/dance was the giving of the Blue Bird Award and it was an honor for Pete and I to receive this special award.

Condolences to the Emmas on the loss of John's mother.

Looking ahead, we know our Presidents Ed & Evelyn are busy rounding up people for classes this year. They expect to have classes before our regular dances. More about this in our ads and flyers. Have a fun year square dancing.

Ad on page 18

Chris & Pete Peterson

718-984-1623



TENAFLY SQUARES -- Haworth, NJ

Financial problems caused us to cancel our May dance, but the June "Moonlight on the Hudson" dance drew a large crowd on an unusually warm evening. The moon didn't shine, but it didn't rain. New graduates and experienced dancers enjoyed the challenging calls by Bob Bourassa, who reminded us that Mainstream dancing can be lots of fun. Our favorite Nick Raspa cued the rounds.

Unfortunately, that was the last dance for our club. Poor attendance at our dances, in spite of having many excellent callers on a convenient night, caused a financial drain on our treasury. It's impossible to continue holding dances. In the past our members have supported other local Mainstream clubs, and now we'll be transferring our memberships to those clubs.

Frank Poole

201-342-3375

46th National Square Dance Convention



June 25-28, 1997

Orlando, Florida



For Information Contact:

Ann and Eddie Millan, Vice Chairman, National Publicity
6693 Bowie Road - Jacksonville, Florida 32219
Phone (904)765-0296 - Fax: (904)768-2262
E-Mail: millane@mail.firm.edu



EARLY BIRD CONVERSION

If you have not converted your Early Bird "Magic Pass," now is the time. Remember, your Early Bird is **NOT** a registration. You will need to convert it to receive your "I Am Registered" ribbon. **You are not registered until the completed Registration Form is returned to us.**

TENAKILL TWIRLERS -- Cresskill, NJ

(MS w/+ tip)

3rd Fri. Oct-May

Bryan School, Brookside Ave.

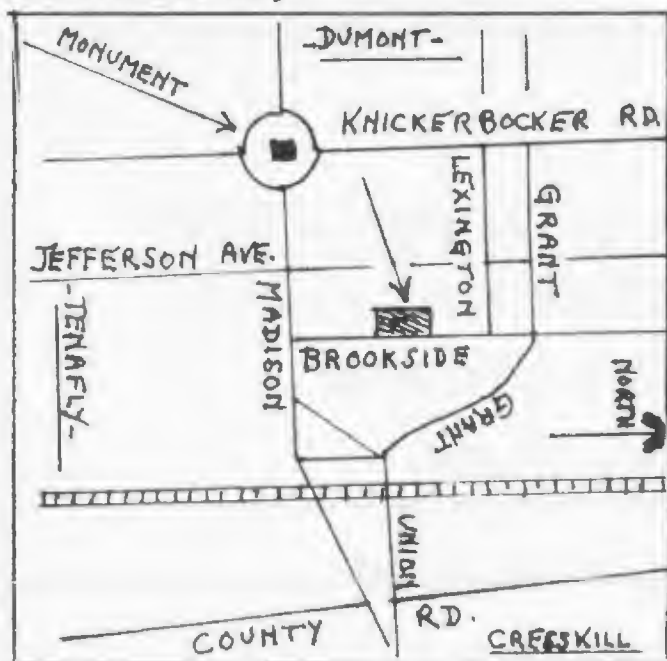

Pres: Fanny & George Meyer
236 N. Queen St, Bergenfield, NJ
07621 201-385-3263

Dele: Bob & Gloria Wyman
402 Ivy Lane, Englewood, NJ 07631
201-569-9120

Our May dance had to be cancelled because the school had inadvertently scheduled another activity for our night, and another location could not be found. But after a long vacation, we'll be back in October with another season of good callers.

Be sure to look for our flyers in the fall, and come over and dance with us. Support your Mainstream clubs! We invite all former Tenafly Squares

members to join Tenakill Twirlers.

Ad on page 12

Frank Poole

201-342-3375

6th Annual

tumbling leaves



festival



October 18-19-20, 1996

Bennington College

Bennington, VT

★ **STAR-STUDDDED STAFF** ★

★ **Bill Harrison**

★ **Red Bates**

★ **Cliff Brodeur**

★ **Tim Crawford**

★ **Jim Pulaski**

★ **Ralph & Joan Collipi**

★ **Esther & Irv Mindlin**



<p>Full C-1 Hall Entire Festival</p>
--

R.V. SPACE AVAILABLE • SQUARE DANCE SHOPS

FOUR HALLS/DANCE LEVELS (PLUS A-1, A-2, C-1)

SEVERAL PACKAGES AVAILABLE

CAMPGROUND NEARBY

For Information, Call or Write:

Cliff Brodeur: P.O. Box 914, Plittsfield, MA 01202 • (413) 443-3060

Red Bates: P.O. Box 7704, North Port, FL 34287 • (941) 423-7143

Pres.: Bub & Fran Baker
25 Cornell Rd, Cranford, NJ 07016
908-272-6316

Dele.: Inge & Herb Ginter
49 Century Lane, Watchung, NJ 07060
908-769-1928

WE HAVE LOST OUR HALL! We are looking for another but don't have confirmation yet. We had to cancel our Sept. 19, Pete Diven Dance. Please call us for our dance location.

As we write, the National Convention in San Antonio is past and the summer dances are in full swing. It's good to keep and (foot!) in during the vacation period. The lazy, hazy days are coming to an end, and we're rarin' to

Look for announcements of new dance location. Map will be printed in the next issue.

go with a great line-up for the new season. Carl Hanks, who was our club caller, has retired and we have a new format. Please remember to call us for our new location.

Ad on page 42

Adele & Peter Widin

908-232-0862

LAKELAND S

TEMPLE BETH AM, 879 SOUTH BEVERWYCK ROAD, PARSIPPANY
MAINSTREAM WITH 1 PLUS TIP EVERY TUESDAY 8:00-10:30 P.M.
ROUNDS & LINES WILL START AT 7:30 ON SCHEDULED NIGHT

*Al & Gale Spinks Cue Rounds — 1st and 4th Dance of each month.
Lois Bichler teaches Western/Line Dances - 3rd & 5th Tuesday*

September 1996

- 10 Pal Johnson - *Al/Gale Spinks*
6:30 pm - *Brown Bag Supper - Bring your supper & club will supply drinks & dessert*
- 17 Bob Mitchell - *Lois Bichler*
- 24 Dick Pasvolsky -
Country Western Night

October 1996

- 1 Bob Mitchell - *Al/Gale Spinks*
(Oktoberfest)
- 8 Hank Lutcher, PA
- 15 Bob Mitchell - *Lois Bichler*
Alumni Night - all former members are invited to join us
- 22 Dick Pasvolsky - *Al/Gale Spinks*
- 29 Jim Snyder, PA - *Lois Bichler*
Halloween Party: Wear a costume if you like

November 1996

- 5 Bob Mitchell - *Al/Gale Spinks*
- 12 Dan Koft - *Kathy Koft (Rounds)*
Veteran's Day Dance! All Vets Please Wear Your Uniforms!
- 19 Bob Mitchell - *Lois Bichler*
- 26 Dick Pasvolsky - *Al/Gale Spinks*
Thanksgiving Pie Nite & Raffle

December 1996

- 3 Bob Mitchell - *Al/Gale Spinks*
- 10 Sam Procopio, PA - *Dolores Procopio (Rounds)*
- 17 Bob Mitchell - *Lois Bichler*
Holiday Student Dance (Students \$2.00)
- 24 NO DANCE - *Christmas Eve*
- 31 NO DANCE - *New Years Eve*

Temple Beth AM is Air Conditioned

Info: Carol 201-334-1196 • Kathy 201-366-8064 • Gail & Butch 201-335-1693

IN MEMORIAM

Carol Rounds, President of Valley Squares, succumbed to leukemia in the spring following a valiant battle. Her death is a tragic loss for the square dancing community as well as for the many other groups to whom she gave so much. Carol was a giver, not a taker, and she touched many lives in her quiet but effective way. Our condolences go out to Duke and her family.

WARREN WHEELERS -- Port Murray, NJ
1 & 3 Thurs. Sept-June

MS/PL tips
Mansfield Twnshp Sch, Pt. Murray Rd & Rt 57

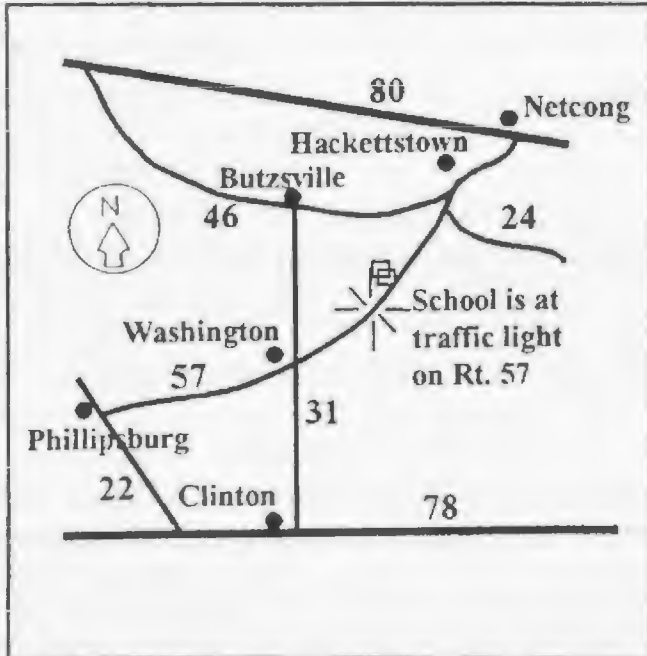

Pres: Ed & Emma Barry
35 Ridge Rd, Budd Lake, NJ 07828
201-691-9055

Dele: Myrtle Jeliffe & Al Kisinski
203 Cemetery Rd, Washington, NJ
07882 908-689-6772

Cl. Coor: Myrtle Jeliffe & Al Kisinski
Address as above.

In May, we had 5 people graduate. They are a friendly, enthusiastic group and we hope to see them at all of our dances. Our last dance in June was a covered-dish supper. The food, as usual, was superb and we all ate too much!

July 4th found us and some visiting clubs at Footbridge Park in Blairstown

putting on a demo with Herb Conklin calling. Although it was raining when we got there, the skies soon cleared and a good time was had by all.

Our new officers took office in June. We want to thank Joe & Mary Alice McGinley and the outgoing officers for doing such a great job this past year. Come dance with us on the 1st & 3rd Thursdays.

Ad on page 60

Barbara & Cal Bacon

908-876-4344

ANNOUNCING Shirley's
Route 9-D, box 423, Hughsonville, NY 914-297-8504 S/D Shoppe

Going out of BUSINESS SALE!

Most items reduced.....
10%, 20%, 30% off

→ **SALE HOURS: By phone CALL FIRST,**
914-297-8504

NOW THROUGH Dec 1st! Shoppe closing date.**

It is never too late to be what you might have been.
George Eliot

WESTERN WHEELERS – Oradell, NJ

PL/A-1 tips

2 & 4 Sat. Sept-June Refrmd Ch of Oradell, 641 Church St (cor. Kinderkamack)

Pres: Gus & Marilyn Bachmann
258 Stevens Ct, New Milford, NJ
07646 201-261-3921

Dele: Cyrene & Bill Finch
313 Wales Ave, River Edge, NJ 07661
201-261-4660

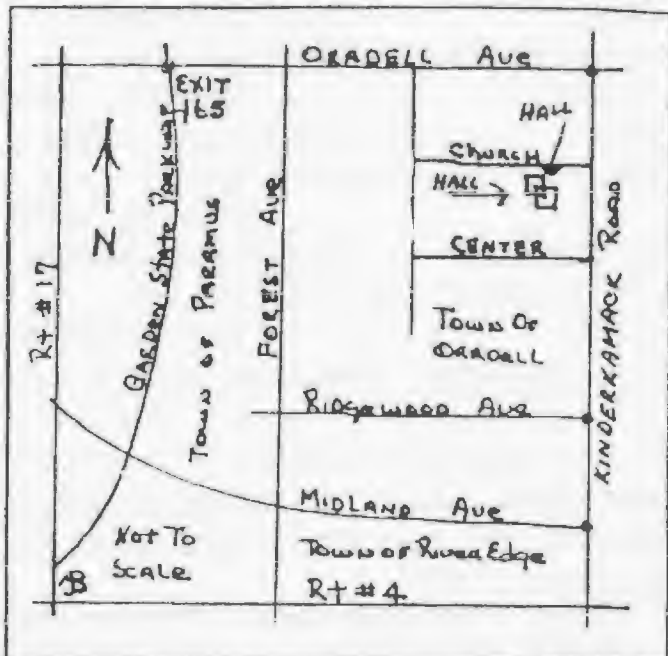

Remember when you graduated square dance lessons? Remember when there were no defined square dance programs? (that goes back in time 20+ years.) Remember when Nick Raspa was a baby; Walter Britt was in the Air Force? These are only a few of the interesting items introduced at our Remember When? dance in April with John K. In May, Marvin Northrup shared International Night

with W/W. Our world travelers displayed some very unique memorabilia from any wonderful places visited. The theme for our last dance of the season was W/W thank you to: 1995-96 Executive Board, W/W members, dancing friends, callers, and our very special cuers and friends, Nick & Carole Raspa. It was celebrated with a sheet cake and great dancing and fun with John K. and Nick.

As a result of annual membership meeting, we are once again very proud to serve as Presidents of W/W for '96-'97. A big W/W thank you to the following wonderful people who volunteered to take a W/W office or committee chairmanship for next season: Brodericks, Beckmanns, Finches, Kerners, LaMarches, Maldonatos, Musantes, Suttons, Weisses, and Wymans. Bless all of you for your enthusiasm, interest, and outstanding support in keeping W/W a friendly, social square dance club.

Ad on page 53

Marilyn Bachmann

201-261-3921

Dear Readers...

It is with deep regret as we begin our seventh year as Editors of *Grand Square* that we announce our resignation effective May 31, 1997.

When we took over *Grand Square*, we promised the Board that we would serve for at least five years. My father's ill health and our increasingly demanding jobs have made this past year the most difficult ever. It has been extremely stressful and each issue has become more and more of a challenge to publish. These situations are not likely to change for the better in the future.

We have begun the search for a replacement and hope that someone will step forward to take over the reins. The sooner we find someone, the sooner we can begin to teach them. We will stay on staff to assist the new editors during their first year.

Grand Square has been part of our lives for nearly ten years. Over these past years, our lives have revolved around deadlines and distribution dates, and we have made it work in spite of several major adversities. We are very proud of the improvements we have made, facilitated mainly by the computer, to deliver the most current, up-to-date information available to the dancer.

Our sincerest hope is that there is someone out there who has that same love for the information, that love of creating a beautiful magazine, and most importantly that love of square dancing. Call us or Sal & Mary Alessi, NNJSDA Presidents (telephone numbers on page 2), if you are interested.

Kathy & Charlie Porter, Editors

Y SQUARES -- Clark, NJ

MS

2 & 4 Fri. Sept-May

Carl Kumpf School, Mildred Terr.

Pres: Joe & Jean Magnani
4606 Stonehedge Rd, Edison, NJ
08820 908-756-0268

Dele: Bill & Alice Lambert
28 Exeter Rd, Clark, NJ 07066
908-382-2070

Cl. Coor: Dick & Joan Murtha
147 Garden Dr, S. Plainfield, NJ
07080 908-757-5446

Hi everyone! Welcome back, hope your summer was great and filled with lots of dancing. Y Squares, as part of the Five Clubs, enjoyed 6 great dances this summer. Hope some of you were there.

Sadly, I attended Merri Eights last dance in June, and remembered with fondness the nights the club had 22 squares in attendance. No one would have ever believed they would not go on forever, but poor attendance and club support (lack of officers) caused their demise. No club is immune, so support your club with your attendance and JUST SAY YES when asked to be an officer or provide some refreshments. A club is only as strong as its membership. A full dance hall makes everyone happy, members and guests alike. Speaking of full dance halls, we are looking forward to welcoming all the new graduates this season.

Ad on page 33

Jean Koenig

908-276-8049



SQUARE VIEW

BY
MANNY AMOR



50 "WAIT 'TIL YOU HEAR THIS NEXT SINGING CALL"

THINGS YOU CAN DO WITH A BANDANA

by Rusty

Ball



Just got back from San Antonio, the National S.D. Convention, and guess what ranks right behind boots and cowboy hats as THE fashion find of the decade? Why, bandanas, of course. One of the sewing sessions actually had a hand-out with 27 things you can use a bandana for, ranging from neckerchief to bib, bread cozy to placemat, to splint, rope, and bandage! However, we will limit our discussion to some things you can SEW from a bandana.

Have you heard of a Texas Lei? Very colorful addition to a T or top : Fold a bandana in half diagonally. Starting at the point, fold it up 1½", and keep folding until you have a long strip. (It will get wider as you fold, but should be no wider than 2".) Sew TWO rows of straight stitching down the center (in case you slash one). Cut along the long folds so all layers are single. Then slash nearly to the stitching every ½" or so (straight or diagonal--makes no difference that I can tell). Finally, dampen it slightly and throw it into the dryer to make it 'fluff'. Tie it around your neck, your head, whatever. (You can use the pieces from other projects for this one, too.)



A different collar made from a bandana (we saw this one over a t-shirt that had had tight zig-zag done over the sleeve hems and neckline--called lettuce edge.) Fold a bandana in half diagonally. Lay it under a T-shirt neckline, and copy the oval shape of the neckline; add a 3" opening in the back if necessary. Cut out, turn under, and hem finely. Then cut ½" x 4" slashes over each shoulder and front and back. Thread 3-4 pony beads on each slash and tie a knot in the end. Add conchos and more pony beads, tied on with strips cut from the neck cutout.

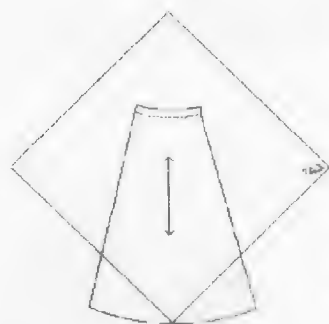
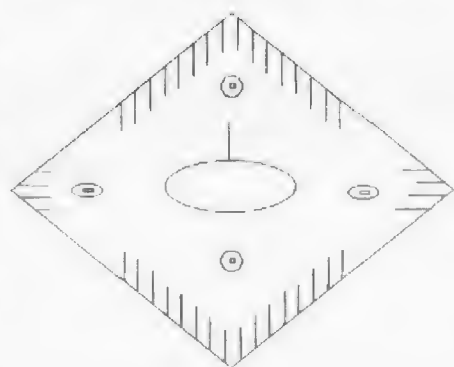

Finally a skirt: Lay 8 bandanas on top of each other right side up, with the writing that is on the corner at the side or top. Use two hemmed edges at the bottom point--the pattern will not meet at the sides if the selvedge is used because the design is usually farther away from this edge. Lay your favorite 8-gore pattern over these, with the bottom of the pattern at the bottom point. Cut out the gores, and cut a waistband from the remaining bandana pieces; sew it together for a great and quick overskirt--or looks good over a nice petticoat, too.

Texas was great--17,000 square dancers invaded the Alamo city. The residents saw our colorful outfits and our dangles and thought we were competing for "medals"--we told them we get the "medals" for dressing like that in public! NJ's own Red Rose performed--and a beautiful job they did, too!! Everyone should make at least one National in their life--1997 is in Orlando, and in 2000 it will be in Baltimore!



20th Anniversary Myrtle Beach Balls

CONVENTION CENTER

21st Avenue and Oak Street

Myrtle Beach, S. C.

SEPTEMBER 11, 12, 13 & 14, 1996

SQUARES:

TONY OXENDINE

Sumter, South Carolina

BRONC WISE

Cool, California

JERRY STORY

Mission, Texas

BILL HARRISON

Upper Marlboro, Maryland

JERRY BIGGERSTAFF

Marion, North Carolina

ROUNDS:

JERRY & BARBARA PIERCE

Birmingham, Alabama

CURT & TAMMY WORLOCK

Plant City, Florida

LINE DANCING AND TEXAS TWO-STEP:

NELSON JARVIS

Columbia, South Carolina

DANCE:

Mainstream, Plus and Rounds (2 Halls), Plus DBD, Advance and C-1

ROUND DANCE — Phases II - VI

Workshop & Dancing — Line Dancing and Texas Two-Step

Callersama, Fashion Show, Sewing Clinic, Callers "Rap" Session
and AFTER PARTY: "MISS MYRTLE BEACH BALL" BATHING BEAUTY CONTEST

1997 DATES

April 10, 11, & 12
September 24, 25, 26, & 27

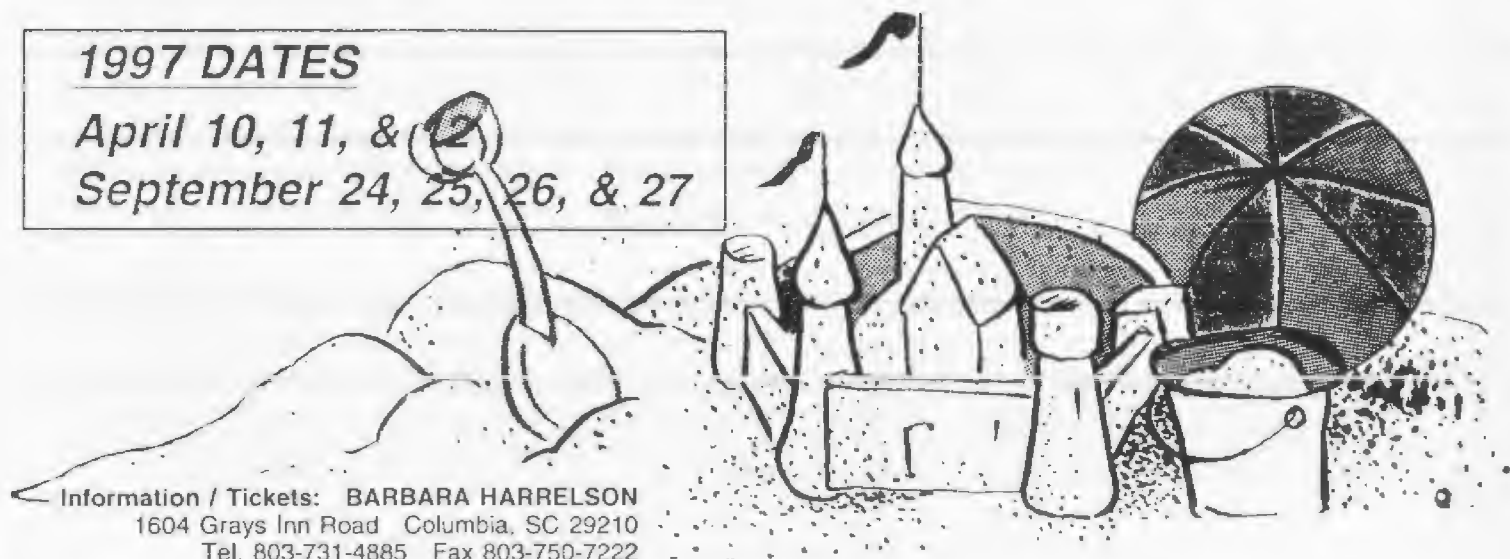

Information / Tickets: BARBARA HARRELSON
1604 Grays Inn Road Columbia, SC 29210
Tel. 803-731-4885 Fax 803-750-7222

LEVELS OF THE DANCE

by Dick Mazziotti, Caller/Teacher

Did you know that square dancing has 9 more different PROGRAMS, and 6 different LEVELS. A PROGRAM is a list of calls (Basic Program, Mainstream Program, Plus Program, etc.).

The LEVELS of square dancing reflect the CAPABILITY of the dancer and caller, not the number of PROGRAMS one has crammed in, and are applicable to EACH PROGRAM. The LEVELS are: (1) Learning; (2) Boring; (3) Comfortable; (4) Interesting; (5) Excellent; (6) Outstanding. If you are dancing at level 2 or 3, adding another PROGRAM is little like jumping off a bridge. The view may change, but the end result is not always comfortable.

WE HAVE MET THE ENEMY AND HE IS US!

Comments from dancers are being passed on to me lately that would lead a reasonable person to believe that there are some popular stories skulking about that are taking on the protective trappings of fact that may, in the end, be harmful to the activity. In other words, we need a whole lot more fertilizer and a whole lot less BS or the effluvia is going to soon hit the propeller. There are **myths** (like Aesop's Fables that all recognize as fanciful), there are **truths** (like gravity, taxes and greediness of politicians) that all accept as real, and there are **tryths** (they sound right but go left)!

Tryth: Mainstream is more interesting than Basic, Plus more interesting than Mainstream (an absolute tryth), Advanced more interesting than Plus, and Challenge more interesting than sex.

Discussion: Anyone who has ever seen Tony Oxendine or Tommy Miller, or for that matter some of our local callers like Betsy Gotta, Dan Koft, and many

Please turn to page 54

>>>> 1996-1997 Dancing Schedule <<<< Western Wheelers S/D Club

>> Second & Fourth Saturdays <<

THE REFORMED CHURCH of ORADELL
Hall 201-261-1720

641 Church Street @ Kinderkamack
Oradell, N.J.

Pre-Rounds 7:30

PLUS DANCING

8:00-10:15

"A" After Tip

Nick Raspa, Club Cuer

[] 9-28-96	Frank Riviccio	[] 2-8-97	Frank Riviccio
[] 10-12-96	McFarland	[] 2-22-97	Roy Leber
[] 10-26-96	Randy Page	[] 3-8-97	Randy Page
[] 11-9-96	Don Coy	[] 3-22-97	Roy Leber
[] 11-23-96	Roy Leber	[] 4-12-97	Frank Riviccio
[] 12-14-96	Randy Page	[] 4-26-97	John Kaltenthaler
[] New Years Eve, 1996		[] 5-10-97	Randy Page
[] 1-11-97	Doug Kaufman	[] 5-24-97	McFarland
[] 1-25-97	Dick Mazziotti	[] 6-14-97	Dick Mazziotti

Mark Your Calender check our flyers

dance with Western Wheelers

INFORMATION: 201 / 261-3921, 569-9120 or 914-352-0627

Mazziotti Column continued from page 53

others really use the Basic or Mainstream programs, they know what dancing at the "Interesting" level and above level is (see Levels below).

Tryth: *Better dancers dance more programs. (Corollary: The more programs you cram in, the better dancer you are.)*

Discussion: Utter BS! Each program, Mainstream, Plus, etc., can be broken up into levels. The levels of dancing, in ascending order, are: Learning, Boring, Comfortable, Interesting, Exciting, and Outstanding! And there are dancers in every program who qualify for each level.

Tryth: *The more members a club has, the stronger it is.*

Discussion: Every club consists of the following: Those who Set The Tone for the club (4 people); Willing Workers (15%), Regular Dancers who come regularly but can't get involved (35%); Occasional Dancers who come every three months (15%); and a varying number whose names are on the roster but to all effects and purposes Do Not Exist. When the "Set The Tone" group becomes fewer than four, and/or the "Willing Workers" percentage equals fewer than one person, the club is in trouble.

Tryth: *Some callers delight in taking down a square.*

Discussion: Total, utter BS! Because any caller can take down any square, anytime, anywhere, in 2-5 calls. What some callers do expect is that dancers who profess to dance the Plus program are able to do all the Basic and Mainstream program calls, and that dancers who profess to be Advanced dancers are able to do all the Basic, Mainstream, and Plus calls. And if you are complaining about a caller, it may just be that he or she is calling Interesting when you are only able to do Boring (see levels of dancing above).

Kings' Squares

Brooklyn's First Square Dance Club

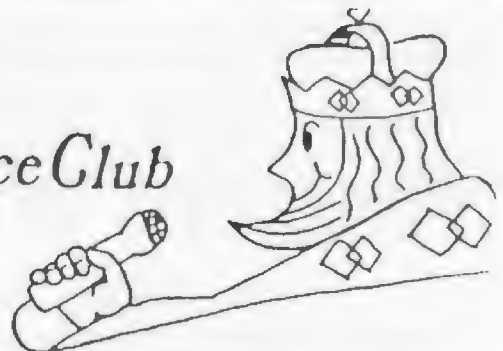

KINGS' SQUARES 1996-1997 DANCE SCHEDULE
1st and 3rd Sundays ♪ 7.30 - 10.00 P.M. ♪

1996

September 15	Sandy Corey	Welcome Back!
October 6	Randy Page	Square Dancing is Fun
October 20	Frank Riviccio	22nd Anniversary Dance
November 3	Betsy Gotta	Apple Festival

REDEEMER ST JOHN LUTHERAN CHURCH
939 - 83RD STREET, BROOKLYN, NY (Between 7th and 10th Avenues)

For further	Jim Hamilton	718/836-3848	Dance	\$4.00 per person
information	Pat & Bernie Monsen	718/745-3616		\$8.00 per couple

DIRECTIONS:

FROM BELT PARKWAY: Exit 4 (Bay 8 St /14th Ave.), left turn at light, Bay 8th Street, left turn at next light, 14th Avenue, continue to 7th Ave., right turn on 83rd St. Church is on left near next corner (10th Ave.).

FROM VERRAZANO BRIDGE: Exit 92nd St., right to 7th Ave., at 7th Ave left turn, continue to 83rd St., right on 83rd St. Church is on left near next corner (10th Ave.)

Pick battles big enough to matter, small enough to win.

Jonathan Kozol



COME DANCE WITH US!



LEISURE SQUARES

1st and 3rd SATURDAYS

DALT YOUNG Calling Squares

Rounds by: ED MILLER



DANCE HELD AT
J. M. HILL SCHOOL
East Broad Street
East Stroudsburg, PA

FALL SCHEDULE 1996

8:00 - 10:00 p.m.

OCT	5	OCTOBER FEST
	19	MASK PARADE DANCE
NOV	2	CAST YOUR VOTE DANCE
	16	THANKSGIVING DANCE <i>(food basket donations welcome)</i>
DEC	7	CARDINAL DANCE <i>(all singing calls)</i>
	21	CHRISTMAS DANCE

NO DANCES IN JAN. AND FEB., 1997

MAR 1 ALOHA DANCE

Dancing M.S. & Plus alternately
Information: 610-838-0651



ANGELS

With the start of a new square dance season at hand, it is time to review the role of angels for your classes. Not all clubs appreciate angels to the same degree. The callers, however, may have a different view on angels and their helpfulness during class.

The best reason to use angels is to insure that no new dance learner ever has to sit out during a tip of instruction. The second major reason for using angels during classes is that learning will occur more rapidly if there are more dancers on the floor, and the angels are dancing to provide stability.

Speaking as one caller, let me share some ideas with you on how to be a good angel. The best help an experienced dancer can be to a new dancer is to be where you belong with a smile on your face and a zipper on your lip. This is especially important during the actual time the caller is giving the instructions for a particular call. Most callers will just stop and wait until the angels have stopped talking and then proceed with the lesson. Perhaps that is a little harsh but dancers can only learn from a single instructor and, if you tell the dancers where to go or push them where you think they ought to be, you are not helping the learner dancers. Dancers need to accomplish the move by themselves. If they rely on an angel to tell them where they should be or where they should go, they will use the angel as a crutch and will not learn how to do the calls by themselves.

It is also important to realize that most callers have attended one or more callers' schools and part of the curriculum instruction they received included

Please turn to page 56

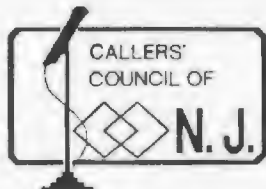

CCNJ continued from page 55

various aspects of teaching. Of course, the callers generally know the exact definition of the call they are teaching at any given time. As angels, you probably know how to do a move but perhaps you are not familiar with the starting formation and timing of the call and the exact wording of the definition. If the dancers ask a question of the angels, it is most helpful if the angel takes that dancer to the caller/instructor to ask the questions. They way, you are reinforcing the proper roles of the learner, angel and caller.

We, as experienced dancers, want to show how much we know and how much fun we have while dancing. Having said that, let me add a caveat to all angels who help with classes. Never do more than the caller has taught and do not show flourishes or twirls if the caller has not yet taught them. Even though you personally may like to slide to a line, listen to the caller when s/he teaches Circle To A Line and do it the way the caller is teaching. Be helpful, be courteous and above all be where you belong with a smile on your face and a zipper on the lip. Yours for happy dancing,

John Kaltenthaler, President, CCNJ

MASQUERADERS

DATE	CALLER	CUER
SEP. 6	AL KAESLER	TOM DENNISTON
SEP. 20	NO DANCE	
OCT. 4	AL KAESLER	TOM DENNISTON
OCT. 18	MARION PEARCE	RON RUMBLE
NOV. 1	AL KAESLER	RON RUMBLE
NOV. 15	DALT YOUNG	TOM DENNISTON
NOV. 29	NO DANCE	
DEC. 6	AL KAESLER	KAREN KUSHLA
DEC. 20	BRIAN FUGURE	RON RUMBLE
JAN. 3	AL KAESLER	RON RUMBLE
JAN. 17	JIM SNYDER	TOM DENNISTON

Plus Level Squares 8:00 to 10:30

Pre rounds 7:30

AMERICAN CZECHOSLOVAK CLUB, Hankins Road, East Windsor, NJ. Just off Route 130. Four lights south of Route 571 (Princeton-Hightstown Road) or two lights north of the junction of Rts 130 and 33.
Call: 609-448-3981 OR 609-448-4548

Round Dance Clubs . . .

RAMAPO RHYTHMAIRES -- Rutherford, NJ

Mondays

Annunciation Ukrainian Church, Home Ave.

This fall will once again find us establishing a class for aspiring round dancers. If you have been standing on the sideline, admiring the round dancers as they glide around the dance floor and have felt inclined to become part of the wonderful world of round dancing, come join us. We find ourselves a bit "antsy" after the long summer and are anxious to welcome both new and seasoned dancers.

Nick & Carole Raspa

201-896-1891



Northern New Jersey Round Dance Leaders Council

As the fresh dancing season blooms, we feel the call to reach out to all who have been admiring the round dancing they observe, longing to partake, yet find themselves intimidated, believing themselves incapable of ever learning the "art" of round dancing. We encourage you to bring your "two left feet" to your local round dance leader and experience real joy as you realize that you are indeed round dancing. Bear in mind that round dancing involves just you, your partner, music, and cues to include a great deal of pleasure. North, south, east, and west lights on a host of talented cuers ready, willing and able to convey a wealth of knowledge to enable you to join and enjoy this wonderful sport (we do admit that we are very, very prejudiced). Look for flyers which will reflect round dance classes to be held in your area. There is a strong probability that classes are being given on a convenient evening for you. You are certainly most welcome to call and/or ask any leader in your area about classes that are being held. We look forward to extending a welcome as you complement your square dancing and enjoy the wonderful full enrichment of the round dance world.

We would be remiss were we not to remind you that plans are currently underway for the annual Fall Festival of Rounds. Every effort goes into providing a relaxed program of dancing to all your favorite NNJRDL cuers. The program chairman assures us that some real delights are in the planning. Your part is only to support your leaders and attend this wonderful affair. It will be held the first Sunday in November at the VFW Hall in Elmwood Park. Post your calendar to ensure yourselves another fine afternoon of dancing pleasure.

Ad on page 71

Nick & Carole Raspa

201-896-1891

SEE SAW

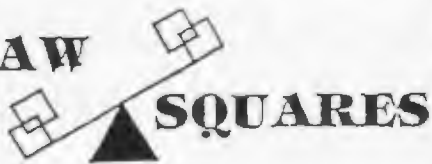

**Old Stone Church Education Center
500 East Saddle River Road
Upper Saddle River, NJ
Church Phone: 201-327-5242**

PLUS DANCING ON THE THIRD SATURDAY

**8:00 All-position PLUS workshop
8:30 PLUS tips
10:30 ADVANCED tip**

Sept.	No dance
Oct. 19	RANDY PAGE
Nov. 16	JOHN KALTENTHALER
Dec. 21	HOWARD RICHMAN

**Info: Lyn & Bob 201-327-9274
Joan 914-353-2987
Raids: Carolyn 914-358-6043**

**Easy directions: GSP exit 172,
west on Grand Ave., north on East
Saddle River Road to Weiss Road.**

LETTERS TO THE EDITORS. . .

We believe **Grand Square** and NNJSDA members could benefit from an idea picked up from an out-of-state dance magazine; namely, immediately following the Dance Calendar in Grand Square, a section be added entitled Classes & Workshops. This section would have a similar format to the Dance Calendar by listing: month, date, club, caller/teacher/contact, and program of the activity.

For classes, this would permit listings of all class meeting dates; for workshops, broad publicity of the activity to all NNJSDA members instead of flyers, which are frequently missed; for M & M Squares, a regular listing if considered a workshop; and for Plus classes offered by clubs following completion of Mainstream classes, a notice of these classes is not otherwise available.

This idea was picked up from the *Northeast Square Dancer*, a monthly by subscription serving New England with 50± pages content. The number of workshops noted in most issues approximates the number of dance listings. No wonder we were impressed with the quality and skills of New England dancers. Logically, skills will increase as workshops receive increased publicity and their number increases. We have previously written of the importance in our view of post-graduate workshops and that their absence was a likely major contributor to new graduate attrition. Hopefully, as the opportunity to improve skills increases, fewer dancers will fall by the wayside.

Jim & Catherine Douglas, Bloomfield, NJ

Red Bates. . .

Calling 1996 Festivals and Weekends:

- Sept. 21-22 **Watkins Glen Festival**, Friendship Squares, Geneva, NY
Contact: John Acquilano: 315-789-2283
- Oct. 18-20 **6th Annual Tumbling Leaves Festival**, Bennington, VT
Cliff Brodeur, Tim Crawford, Bill Harrison, Jim Pulaski, Ken
Ritucci, Red Bates, Ralph & Joan Collipi, Erv & Esther Mindlin
Plus thru C-1. Contact: Cliff Brodeur 413-443-3060.
See ad page 46.
- Nov. 1-3 **Sebring A-2 Weekend**, Sebring, FL
Callers: Glenn Zeno, Red Bates, Cuer: Carolyn Zeno
Kenilworth Lodge, Sebring, FL
- Nov. 15-17 **Mystic Adventure Plus Weekend**, Mystic, CT
Cliff Brodeur, Red Bates, Ralph & Joan Collipi
See ad page 40.
- Dec. 6-8 **Dynamo A-2 Weekend**, Mystic, CT (formerly held in Keene, NH)
Jim Pulaski, Red Bates, Ralph & Joan Collipi
Contact: Jim Pulaski 508-366-4464

For information contact Red Bates:

May-Oct: 82 Regecy Park Dr., Agawam, MA 01001 413-786-0212
Oct-May: PO Box 7704, North Port, FL 34287 941-423-7143

Don't be afraid of the space between your dreams and reality.
If you can dream it, you can make it so.

Belva Davis

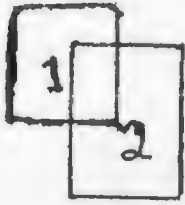

ROCKAWAYS

ADVANCED WORKSHOP CLUB
with caller John Kaltenthaler

New A-1 class begins September 9, 1996
Mondays - 7:30 to 9:00 PM Casual Attire
Advanced Dancing from 9:00 - 10:15 PM
Rockaway United Methodist Church Hall
Valley Road - Boonton Township, NJ
For further information call Freddie
717/646-2945 or Elsie 201/335-0127

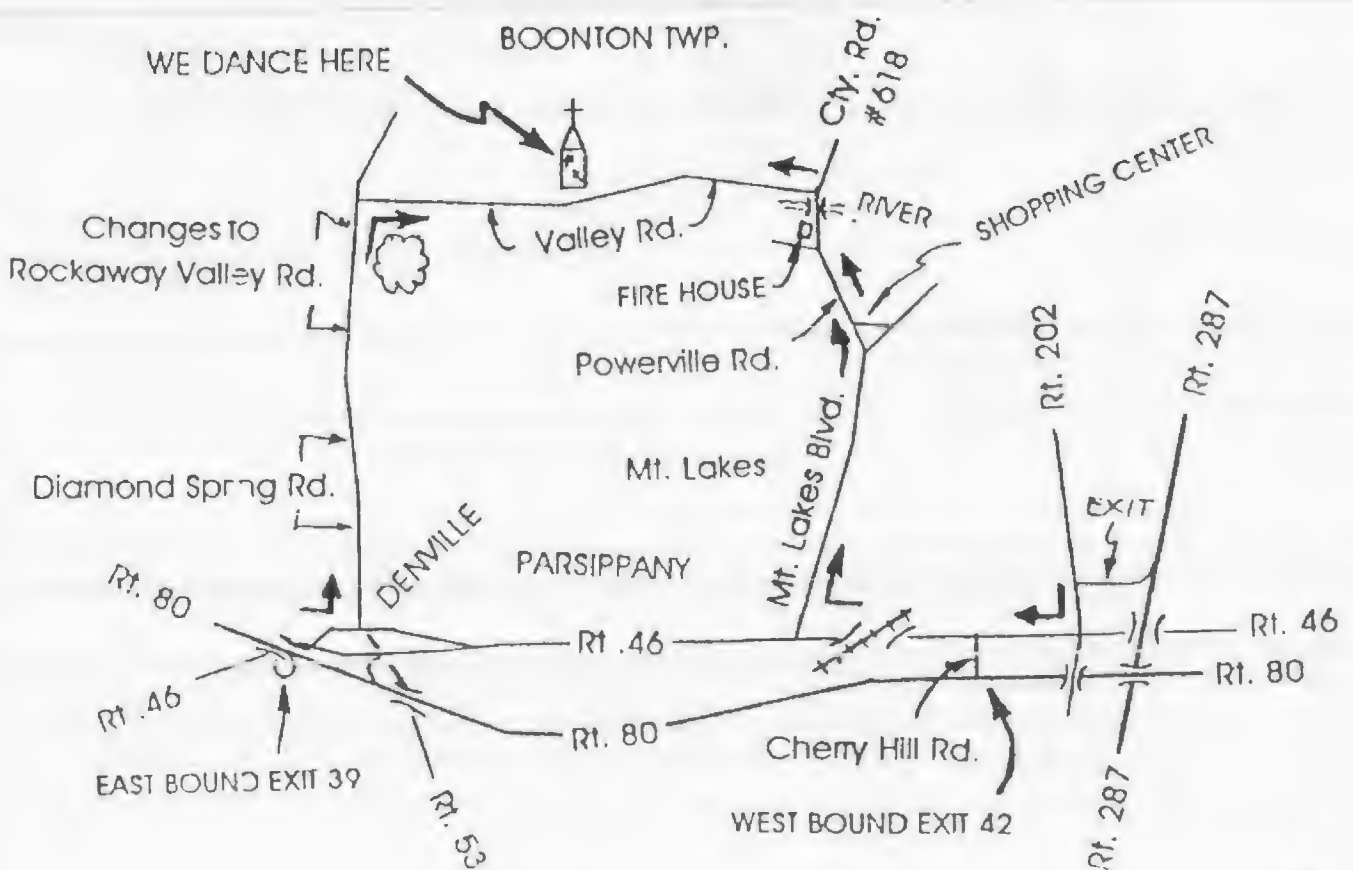

WARREN WHEELERS

MANSFIELD TOWNSHIP ELEMENTARY SCHOOL
 AT TRAFFIC LIGHT 3 MI. E. OF WASHINGTON,
 8 MI. W. OF HACKETTSTOWN, ON
 RT 57, PORT MURRAY, NJ
 8:00 TO 10:30 PM

MS &
 PLUS



-INFO-

RIZZO (908) 850-4394
 KOZAREK (908) 475-2799
 SCHOOL # (908) 689-9856

SEP 5	ED KERNS	(OPEN HOUSE)
SEP 19	DICK PASVOLSKY	
OCT 3	DALT YOUNG	
OCT 17	DICK PASVOLSKY	
NOV 7	DICK MAZZIOTTI	
NOV 21	DICK PASVOLSKY	
DEC 5	DICK PASVOLSKY	
DEC 19	HERB CONKLIN	(CHRISTMAS)*
JAN 2	BOB KOZAREK & FRAN WADEL	(2 FER)

* STUDENTS FREE

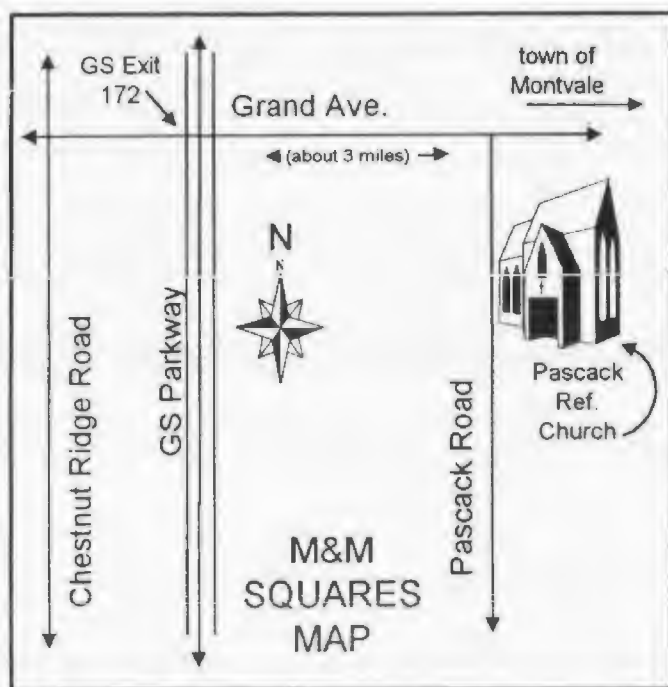

*This club is not currently a member of the
 NNJSDA...*

M & M SQUARES – Park Ridge, NJ
 1st Sat. All Year Basic
 Pascack Reformed Church
 65 Pascack Rd.

Pres: Laurel Mazziotti
 342 Liberty Ave, Hillsdale, NJ 07642
 201-664-4482

Ad on page 11

ATTENTION ALL CLUB PRESIDENTS

5 copies of your club's roster and your dues are due
 by November 15, 1996. Send them to the NNJSDA Treasurers,
 Jim & Barbara Thoma, 8 Wilson Ave, Staten Island, NY 10308.



*This club is not currently a member of the
NNSDA...*

MASQUERADERS -- E. Windsor, NJ
1, 3 & 5 Fri. Sept-May PL
American Czech Farmers Club,
130 Hankins Road

Pres: Patricia & Larry Kraft
11 Cedar Lane, E. Windsor, NJ 08520
609-448-3981

Ad on page 56

BUILD CONFIDENCE • SHARPEN SKILLS • REINFORCE LESSONS

BASIC, MAINSTREAM and PLUS SECOND HALF PROGRAM VIDEOS

Callerlab
approved!



Broadcast quality
video tapes. Filmed
in television studio,
featuring overhead
shots.

BASIC
SECOND HALF
(movements 26-50)
\$49⁹⁵

Featuring BETSY GOTTA,
Caller, 30+ years. Member
Board of Governors,
Callerlab.

PLUS
(27 movements)
\$49⁹⁵

MAINSTREAM
(Callerlab sequence 51-67)
\$39⁹⁵

Outside U.S. add \$10. Specify
"Payable in U.S. Dollars."
Check or MO only.

© 1987-1990 Tra Bien, Inc.

Add \$3.50 postage and handling • N.J. res. add 6% sales tax



Please specify BASIC MAINSTREAM PLUS VHS BETA

Mail check or money order to:

SQUARE DANCE VIDEOS

A Division of Tra Bien, Inc.

P.O. Box 1350, Maplewood, NJ 07040



Name (Please Print) _____

Address _____

City _____

State _____ Zip _____

GS

CALLERLAB QUARTERLY AND EMPHASIS SELECTIONS



- | | | |
|---------------------|------------------------|--------|
| Mainstream: | Hinge Over | (9/95) |
| Plus: | Luciky Star | (7/96) |
| Advanced: | Pass & Roll Chain Thru | (5/96) |
| | Scatter Scoot | (5/94) |
| | Cross the K | (9/95) |
| | Six-Two Acey Duecey | (1/96) |
| Mainstream Emphasis | Scoot Back | (5/96) |
| Plus Emphasis: | Extend | (7/96) |

Rockland Promenaders

Mainstream Dancing
Second Sunday of the Month



Featuring
Instructed Western Line Dancing
between Tips

Please Note our
NEW, NEW LOCATION

Less than 2 Miles from GSP Exit 172

Green Meadow Waldorf School

Route 45 at Hungry Hollow Road
Chestnut Ridge, New York
7:30pm - 10:00pm
Soft-Soled Shoes REQUIRED

DANCE SCHEDULE

1996

September 8 Roy Leber

October 13 Howard Richman

December 15 Don Coy

1997

January 12 To Be Announced

For Information Call:

Tom & Bonnie Silk	914-365-0525
Len & Carol Steinfeld	914-354-4374
Al & Ilse Dill	914-359-4374

Directions: From GSP Northbound Exit 172, turn left at end of ramp onto Grand. At the traffic light turn right onto Chestnut Ridge Road. Green Meadow Waldorf School is less than 2 miles on your left.

From GSP Southbound from the NYS Thruway, exit at Red Schoolhouse Road, turn right at the end of the ramp. When Red Schoolhouse Road meets Route 45 (traffic light), turn left. Green Meadow Waldorf School is less than 1 mile on your right.

SQUARE DANCING IN THE PHILADELPHIA INDEPENDENCE DAY PARADE

by Rich Delgado, VP, SDCNJ

I had the privilege of participating in the Philadelphia July 4th Parade. The parade celebrated the 220th Anniversary of the Declaration of Independence and square dancing was televised on WPVI-Channel 6 (ABC) for two and half minutes.

In late June, I received a flyer mailed by Joan Lechner, Vice Chairperson of the Federation of Delaware Valley Square and Round Dancers (Del Val), inviting dancers to march and dance with the Square Dancing Float. After participating in a demo with the Marionettes Square Dance Club at the start of the Ewing Township Independence Day Parade, marching in the parade with Boy Scout Troop 33, and going to the Marionettes' picnic, I took the train to Philadelphia and walked to the parade assembly area. Since the meeting place was ten blocks long, I was happy to find other people in square dance outfits.

Decorations and banners carried on and in front of the float referred to the 49th National Square Dance Convention (NSDC) to be held in Baltimore in 2000, and to the states which have passed resolutions making square dancing the official state folk dance. The caller for the parade, Bruce Mitchell of Cheverly, MD, gave us directions for participation in the parade.

I would like to pass on several things which may be of value to callers and clubs participating in other parades. We marched in groups of two parallel lines of four people. This allowed everyone to march facing forward. When the parade stopped, the caller simply called bend the line and we were in dancing position (facing lines of four) much faster than if we were told to square up.

When the caller knew that we would be stopped for more than a few minutes, we did one or more short singing calls, but more frequently we did a patter demo. However, since home positions are not established by getting into lines, directing heads or sides to do a call sometimes lead to confusion. When the parade was ready to move again, we were given the call "parade," and we then took whatever partner we had at that moment and got into parade position.

By not "resolving" the squares and going back to our original partners, we were ready to go on marching and lost little time trying to catch up to the unit in front of us, or did we create problems for the units in back of us. Becky Stewart, of the Washington Area Square Dancers Cooperative Association (WASCA), organized the event and facilitated our movement by alerting the caller when the parade units ahead of us were about to resume movement.

The exhaust from the float truck was disturbing and somewhat better when marching to the side of the street. A low or zero emission vehicle, if available, would be ideal in this situation.

As we approached the reviewing stand, the float's sound system was cut off and the TV production camera crews positioned us. Our pre-recorded music was then played through the TV station speakers while the caller lip-synched the calls. This allowed a high quality sound signal to be broadcast as well as having our demo fit the allotted time slot.

WASCA participated in the Cherry Blossom Parade and WPVI invited them to participate in the Philadelphia Parade based on the recommendations of the parade management involved with production of both parades. The invitation to join was passed onto the leaders of Del Val.

I would like to thank WASCA and Becky Stewart for inviting local dancers to join the parade and to congratulate them for organizing their participation with a very short lead time. I found them to be an enthusiastic, fun-loving group, and I look forward to participating in the 49th NSDC presented by WASCA and neighboring associations.

(NOTE: A video is available from Burriss Plummer. Contact him via the SD Info line at 800-892-8828, sponsored by the SDCNJ and Del Val.)

Al "e" Mo Squares

Ft. Hamilton Army Base
Community Center
(entrance on 101st Street)
Sundays @ 7:30 pm-10pm

CALLER.....DATE.....THEME

Sept 8.

Don Coy.....Harvest Ball

Oct 13

Andy Woerner.....Wierdest Clothes

Oct 27

Mickey Mc Farland.....Crazy Hats

Nov 24

Jim Emory.....Friendship Day

Dec 8th

Don Coy.....Toys For Tots (1st Student Dance)

Dec 22nd.

Nick Martellacci.....Hoilday Dance

***For our friends who cross the
bridge--We have a raffle for a FREE
TOKEN***

Soft Sole Shoes Only, Please

For Info: Please Call

Vincent @ 718-615-1507

Caroline @ 718-745-3793

Admission \$ 4.00 p/p

The Best Club with the best Callers

Dance Calendar

September to November listing of dances, weekends and workshops prepared from ads appearing **IN THIS ISSUE**. Please see ad for details.

Abbr: A=Advanced; Alt=Alternate; C=Challenge; CW=Country & Western; MS=Mainstream; PL=Plus; RD=Rounds; TBA=To Be Announced; WS=Workshop;

*See caller/cuer ad for details.

Date	Club Program	Caller/Cuer/Leader	Place	Place
September				
4	Belles & Beaux	McFarland	Glen Rock, NJ	MS/PL tips
5	Warren Wheelers	Kerns	Pt. Murray, NJ	Open House
6	Hunterdon Flut.	Hoff/Dockry	Stanton, NJ	Alt MS & PL/RD
8	Al'e'Mo Sqs. Rockland Prom.	Coy Leber	Brooklyn, NY Chestnut Ridge, NY	MS/PL tip MS/CW
9	Spinning Wheels	Robinson/Gesumaria	Wayne, NJ	MS/PL tip/CW
10	Dingman Dancers Lakeland Sqs.	Murphy Johnson/Spinks	Milford, PA Parsippany, NJ	MS/PL tip MS/PL tip/RD
11	Cross Trail Sqs.	Mitchell/Bichier	Caidwell, NJ	PL/CW
12	Belles & Beaux Hix & Chix Rutgers Prom.	Mazziotti Young/Raspa Gottas/Kofts	Glen Rock, NJ Elmwood Park, NJ N. Brunswick, NJ	Open House PL/RD MS/RD
13	Y Squares	Fugere/Kushla	Clark, NJ	Open House
14	Richmond Dancers	Hardy/TBA	Staten Island, NY	PL/RD
15	F.A.D. Sqs. Kings Sqs.	Martellacci Corey	Paramus, NJ Brooklyn, NY	MS/PL tip/CW PL
16	Spinning Wheels	Summers/Gesumaria	Wayne, NJ	MS/PL tip/CW
17	Hi Taw Twirlers Lakeland Sqs.	Kaltenthaler/Raspa Mitchell/Bichler	New Milford, NJ Parsippany, NJ	PL/A-2 tip/RD MS/PL tip/CW
18	Belles & Beaux Ironia Reelers Mountain Sqs.	Kaltenthaler Hoff Landi	Glen Rock, NJ Randolph, NJ Whippany, NJ	MS/PL tips Open House A-2
19	Hix & Chix Warren Wheelers	Dougherty/Raspa Pasvolsky	Elmwood Park, NJ Pt. Murray, NJ	PL/RD Alt MS & PL
20	Ironia Reelers Ocean Waves	Snyder/Spinks Koft	Randolph, NJ Staten Island, NY	PL/RD MS/PL tips
21	Harmony Dancers Staten Sq. Set	Kaesler/Spinks Coy/Coy	Springfield, NJ Staten Island, NY	PL/A tips/RD Barn Dance
23	Spinning Wheels	Hardy/Gesumaria	Wayne, NJ	MS/PL tip/CW
24	Dingman Dancers Lakeland Sqs.	Murphy Pasvolsky	Milford, PA Parsippany, NJ	MS/PL tip MS/PL tip
25	Cross Trail Sqs.	Gotta/Gotta	Caldwell, NJ	PL/RD
26	Hix & Chix Rutgers Prom.	Page/Raspa Koft/Koft	Elmwood Park, NJ N. Brunswick, NJ	PL/RD MS/RD
27	Bee Sharps Circle Eights Kittatinny Rangers Y Squares	Gotta/Gotta Richman McFarland Fugere/Kushla	Somerville, NJ Haworth, NJ Andover, NJ Clark, NJ	PL MS Alt. MS & PL MS/RD
28	Country Prom. Richmond Dancers Western Wheelers	Larsen/Bradt Longobucco/TBA Riviccio/Raspa	Edison, NJ Staten Island, NY Oradell, NJ	PL/RD PL/CW PL/A tip/RD
29	F.A.D. Sqs.	Page	Paramus, NJ	MS/PL tip/CW
30	Spinning Wheels	Robinson/Gesumaria	Wayne, NJ	MS/PL tip/CW
October:				
1	Hi Taw Twirlers Lakeland Sqs.	Ritucci/Raspa Mitchell/Spinks	New Milford, NJ Parsippany, NJ	PL/A-2 tip/RD MS/PL tip/RD

Continued on page 66

October contd.

2	Belles & Beaux Mountain Sqs.	Page Landi	Glen Rock, NJ Whippany, NJ	MS/PL tips A-2
3	Valley Sqs. Warren Wheelers	Richman/Bradt Young	Call for location Pt. Murray, NJ	PL Alt MS & PL
4	Hunterdon Flut. Ironia Reelers Ocean Waves Rockytops	Hoff/Dockry Coy/Spinks Gotta Stapenell/Raspa	Stanton, NJ Randolph, NJ Staten Island, NY Pearl River, NY	Alt MS & PL/RD PL/RD MS/PL tips PL/A-1 tip
5	Harmony Dancers Leisure Sqs. Staten Sq. Set	Kaltenthaler/Spinks Young/Miller Mazziotti	Springfield, NJ E. Stroudsburg, PA Staten Island, NY	PL/A tips/RD Alt MS & PL PL
6	Kings Sqs. NNJSDA - The Gathering	Page Dancers Getting Together to Share	Brooklyn, NY Parsippany, NJ	PL MS/PL
7	Spinning Wheels	Robinson/Gesumaria	Wayne, NJ	MS/PL tip/CW
8	Dingman Dancers Lakeland Sqs.	Murphy Lutcher	Milford, PA Parsippany, NJ	MS/PL tip MS/PL tip
9	Cross Trail Sqs.	Mitchell/Roberts	Caldwell, NJ	PL/RD
10	Hix & Chix Rutgers Prom.	Kaltenthaler/Raspa Gottas/Kofts	Elmwood Park, NJ N. Brunswick, NJ	PL/RD MS/RD
11	Bee Sharps Kittatinny Rangers Y Squares	Koft/Koft Woerner Fugere/Kushla	Somerville, NJ Andover, NJ Clark, NJ	PL/RD Alt MS & PL MS/RD
12	Country Prom. Richmond Dancers Western Wheelers	Foote/Bradt Pasvolsky/TBA Riviccio/Raspa	Edison, NJ Staten Island, NY Oradell, NJ	PL/RD PL/RD PL/A tip/RD
13	Al'e'Mo Sqs. Rockland Prom.	Woerner Richman	Brooklyn, NY Chestnut Ridge, NY	MS/PL tip MS/CW
15	Hi Taw Twirlers Lakeland Sqs.	Kaltenthaler/Raspa Mitchell/Bichler	New Milford, NJ Parsippany, NJ	PL/A-2 tip/RD MS/PL tip/CW
16	Belles & Beaux Mountain Sqs.	Mazziotti Landi	Glen Rock, NJ Whippany, NJ	MS/PL tips A-2
17	Valley Sqs. Warren Wheelers	Page/Bradt Pasvolsky	Call for location Pt. Murray, NJ	PL Alt MS & PL
18	Huntedon Flut. ironia Reelers Ocean Waves Tenakill Twirlers	Hoff/Dockry Koft/Koft Richman Mazziotti	Stanton, NJ Randolph, NJ Staten Island, NY Cresskill, NJ	Alt MS & PL/RD PL/RD MS/PL tips MS/PL tip
19	Harmony Dancers Leisure Sqs. See Saw Sqs. Staten Sq. Set	Larsen/Roberts Young/Miller Page Koft/Koft	Springfield, NJ E. Stroudsburg, PA Up. Saddle River, NJ Staten Island, NY	PL/A tips/RD Alt MS & PL PL/A tip PL
20	F.A.D. Sqs. Kings Sqs.	McFarland Riviccio	Paramus, NJ Brooklyn, NY	MS/PL tip/CW PL
21	Spinning Wheels	Amor/Gesumaria	Wayne, NJ	MS/PL tip/CW
22	Dingman Dancers Lakeland Sqs.	Murphy Pasvolsky/Spinks	Milford, PA Parsippany, NJ	MS/PL tip MS/PL tip/RD
23	Cross Trail Sqs.	Kaltenthaler/Raspa	Caldwell, NJ	PL/RD
24	Hix & Chix Rutgers Prom.	Hardy/Raspa Gotta/Gotta	Elmwood Park, NJ N. Brunswick, NJ	PL/RD MS/RD
25	Bee Sharps Kittatinny Rangers Y Squares	Kaltenthaler/Spinks Snyder Fugere/Kushla	Somerville, NJ Andover, NJ Clark, NJ	PL/RD Alt MS & PL MS/RD

Continued on page 67

October contd.

26	Country Prom. Richmond Dancers Western Wheelers	Carlton/Bradt Kaltenthaler/TBA Page/Raspa	Edison, NJ Staten Island, NY Oradell, NJ	PL/RD PL/CW PL/A tip/RD
27	Al'e'Mo Sqs. Circle Eights	McFarland Paris/Bichler	Brooklyn, NY Haworth, NJ	MS/PL tip MS/CW
28	Spinning Wheels	Coy/Gesumaria	Wayne, NJ	MS/PL tip/CW
29	Hi Taw Twirlers Lakeland Sqs.	Richman/Raspa Snyder/Bichler	New Milford, NJ Parsippany, NJ	PL/A-2 tip/RD MS/PL tip/CW
30	Mountain Sqs.	Kaltenthaler	Whippany, NJ	A-1
31	Hix & Chix	Boo Who?/Raspa	Elmwood Park, NJ	PL/RD

November:

1	Hunterdon Flut. Ironia Reelers Ocean Waves Rockytops	Hoff/Dockry Kaltenthaler/Spinks Martellacci Labounty/Raspa	Stanton, NJ Randolph, NJ Staten Island, NY Pearl River, NY	Alt MS & PL/RD PL/RD MS/PL tips PL/A-1 tip
2	Harmony Dancers Leisure Sqs.	Katenthaler/Kushla Young/Miller	Springfield, NJ E. Stroudsburg, PA	PL/A tips/RD Alt MS & PL
3	F.A.D. Sqs. Kings Sqs.	Johnson Gotta	Paramus, NJ Brooklyn, NY	MS/PL tip/CW PL
4	Spinning Wheels	Robinson/Gesumaria	Wayne, NJ	MS/PL tip/CW
5	Dingman Dancers Hi Taw Twirlers Lakeland Sqs.	Murphy Kaltenthaler/Raspa Mitchell/Spinks	Milford, PA New Milford, NJ Parsippany, NJ	MS/PL tip PL/A-2 tip/RD MS/PL tip/RD
6	Belles & Beaux Mountain Sqs.	Richman Landi	Glen Rock, NJ Whippany, NJ	MS/PL tips A-2
7	Valley Sqs. Warren Wheelers	Leber/Bradt Mazziotti	Call for location Pt. Murray, NJ	PL Alt MS & PL
8	Bee Sharps Kittatinny Rangers Tenakill Twirlers	Young/Booz Martellacci Kaltenthaler	Somerville, NJ Andover, NJ Cresskill, NJ	PL/RD Alt MS & PL MS/PL tip
9	Country Prom. Richmond Dancers Western Wheelers	Kaltenthaler/Bradt Forman/TBA Coy/Raspa	Edison, NJ Staten Island, NY Oradell, NJ	PL/RD PL/RD PL/A tip/RD
10	22nd Mini-Festival	Storey/Jacobs/ Franks/Rumble	Bridgewater- Raritan Middle Schools	All Programs/RD
11	Spinning Wheels	Conklin/Gesumaria	Wayne, NJ	MS/PL tip/CW
12	Lakeland Sqs.	Koft/Koft	Parsippany, NJ	MS/PL tip/RD
13	Cross Trail Sqs.	Mitchell/Bradt	Caldwell, NJ	PL/RD
14	Hix & Chix Rutgers Prom.	Corey/Wagonhoffer Koft/Koft	Elmwood Park, NJ N. Brunswick, NJ	PL/RD MS/RD
15	Hunterdon Flut. Ironia Reelers Ocean Waves	Hoff/Dockry Pearce/Spinks Coy	Stanton, NJ Randolph, NJ Staten Island, NY	Alt MS & PL/RD PL/RD MS/PL tips
16	Harmony Dancers Leisure Sqs. See Saw Sqs. Staten Sq. Set	Fugere/Spinks Young/Miller Kaltenthaler Riviccio/Bichler	Springfield, NJ E. Stroudsburg, PA Up. Saddle River, NJ Staten Island, NY	PL/A tips/RD Alt MS & PL PL/A tip PL
17	F.A.D. Sqs.	Loewenstein	Paramus, NJ	MS/PL tip/CW
18	Spinning Wheels	Pasvolsky/Gesumaria	Wayne, NJ	MS/PL tip/CW
19	Dingman Dancers Hi Taw Twirlers Lakeland Sqs.	Murphy Fellegy/Raspa Mitchell/Bichler	Milford, PA New Milford, NJ Parsippany, NJ	MS/PL tip PL/A-2 tip/RD MS/PL tip/CW
20	Belles & Beaux Mountain Sqs.	Mazziotti Landi	Glen Rock, NJ Whippany, NJ	MS/PL tips A-2

Continued on page 68

November contd.:

21	Hix & Chix Valley Sqs. Warren Wheelers	Richman/Raspa Coy/Bradt Pasvolsky	Elmwood Park, NJ Call for location Pt. Murray, NJ	PL/RD/CW PL Alt MS & PL
22	Bee Sharps Circle Eights Kittatinny Rangers	Richman/Spinks Kaltenthaler McFarland	Somerville, NJ Haworth, NJ Andover, NJ	PL MS Alt MS & PL
23	Country Prom. Richmond Dancers Western Wheelers	Snyder/Bradt Koft/TBA Leber/Raspa	Edison, NJ Staten Island, NY Oradell, NJ	PL/RD PL/RD PL/A tip/RD
24	Al'e'Mo Sqs.	Emory	Brooklyn, NY	MS/PL tip
25	Spinning Wheels	Riviccio/Gesumaria	Wayne, NJ	MS/PL tip/CW
26	Lakeland Sqs.	Pasvolsky/Spinks	Parsippany, NJ	MS/PL tip/RD

*Non NNJSDA Clubs:***September:**

4	Friendly Sqs.	TBA	Livingston, NJ	MS/PL WS
6	Masqueraders	Kaesler/Denniston	E. Windsor, NJ	PL/RD
7	M & M Sqs.	Mazziotti	Park Ridge, NJ	Basic
18	Friendly Sqs.	TBA	Livingston, NJ	MS/PL WS

October:

2	Friendly Sqs.	TBA	Livingston, NJ	MS/PL WS
4	Masqueraders	Kaesler/Denniston	E. Windsor, NJ	PL/RD
5	M & M Sqs.	Mazziotti	Park Ridge, NJ	Basic
16	Friendly Sqs.	TBA	Livingston, NJ	MS/PL WS
18	Masqueraders	Pearce/Rumble	E. Windsor, NJ	PL/RD

November:

1	Masqueraders	Kaesler/Rumble	E. Windsor, NJ	PL/RD
2	M & M Sqs.	Mazziotti	Park Ridge, NJ	Basic
6	Friendly Sqs.	TBA	Livingston, NJ	MS/PL WS
15	Masqueraders	Young/Denniston	E. Windsor, NJ	PL/RD
20	Friendly Sqs.	TBA	Livingston, NJ	MS/PL WS

*Weekends, Festivals, Specials & Conventions:***September:**

11-14	Myrtle Beach Ball	5 callers/2 cuers	Myrtle Beach, SC	All Prog & Phases
21-22	*Watkins Glen Fest	Bates	Geneva, NY	

October:

18-20	Tumbling Leaves	5 callers/2 cuers	Bennington, VT	PL/A/C-1/RD
27	B-T Homecoming	Rowe/Rumble	Hamilton Sqs., NJ	PL/A-2/RD

November:

1-3	Sebring A-2 Wknd	Zeno/Bates/Zeno	Sebring, FL	A-2/RD
3	NNJRDLC Fall Fest.	Many cuers	Elmwood Park, NJ	All Phases
15-17	Mystic Wknd.	Bates/Brodeur/Collipi	Mystic, CT	PL/A-1/RD
22-24	Turkey Trot Wknd	Oxendine/Flegos	Parksville, NY	PL/A/C-1/CW

December:

1	Hix & Chix	Flippo/Raspa	Hasbrouck Heights, NJ	PL/RD
6-8	Dynamo A-2 Wknd	Pulaski/Bates/Collipi	Mystic, CT	A-2/RD
31	Belles & Beaux Western Wheelers	Coy/Coy TBA	Dumont, NJ Oradell, NJ	MS/CW PL/A tip/RD

April '97:

10-12	Myrtle Beach Ball	5 callers/2 cuers	Myrtle Beach, SC	All Prog & RD
-------	-------------------	-------------------	------------------	---------------

September '97:

24-27	Myrtle Beach Ball	5 callers/2 cuers	Myrtle Beach, SC	All Prog & RD
-------	-------------------	-------------------	------------------	---------------

PARSIDDANY HILLS HIGH SCHOOL:

From the North:

287 South to 80 West; first exit. 42A. "Morris Plains" 202 South. Bear right and continue 1 mile on Rte. 202 South (Littleton Rd.) Pass St. Christopher's RC Church and turn right onto Rita Drive. H.S. is at end of Rita Drive.

From the East:

Rte. 80 West to exit 42A and see above.

From the West:

Rte. 80 East to exit 42A and see above.

From the South:

Rte 287 North to exit 39, Rte. 10 West. 1 1/2 mi. To Rte. 202 North (Littleton Rd.) North 202 for 1 1/2 mi.: pass Mobile station on right, next left onto Rita Drive. H.S. is at end of Rita Drive.

MAP FOR THE GATHERING

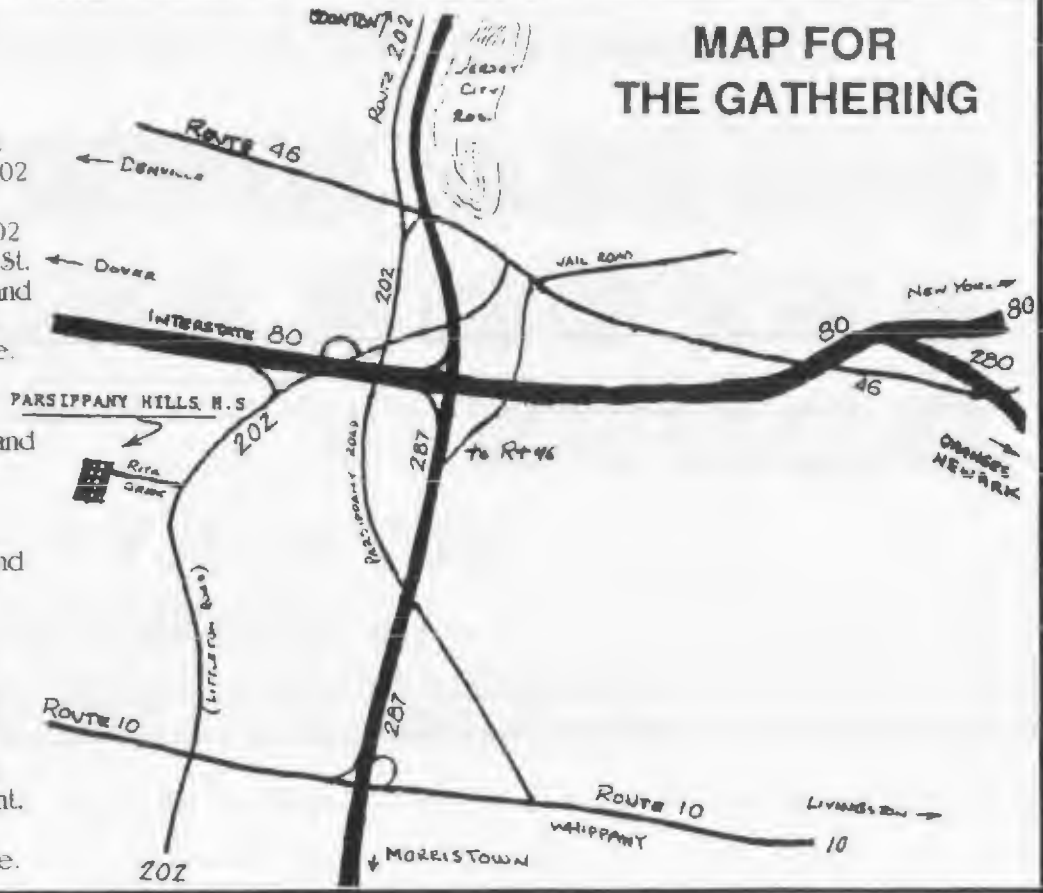

MAP FOR THE MINI-FESTIVAL

DIRECTIONS TO BRIDGEWATER-RARITAN MIDDLE SCHOOL

FORMERLY - BRIDGEWATER-RARITAN HIGH SCHOOL - EAST

HALL TEL. NO. 908-526-9824



FROM RT 80 EAST OR WEST

Rt. 80 to Rt 287 South to Rt. 202-20 South (Exit 13) to Rt. 22 East. Proceed 2-1/2 miles to Finderne Ave./Manville Sign. Turn right on Finderne Ave., pass light, and turn right onto Foothill Road. Proceed 1.1 miles (you will go over Rt. 22) to Merriwood Rd. Make a left onto Merriwood Rd. Proceed into school driveway. Drive around school to side and front parking lots. No parking at yellow curbs. Park in lined areas only.

FROM RT. 78 EAST OR WEST

Rt. 789 to Rt. 287 South to Rt. 202-206 South and follow directions above.

FROM RT. 287 NORTH

Rt 287 north to Rt. 22 West (merge to right lane on Rt. 22). Proceed approximately 1 mile. Make a right onto North Gaston Ave. (this is a small street, Midas Muffler is in center island opposite N. Gaston Ave.). Follow N. Gaston to "T" (Somerville Rd.). Turn right and proceed for one long block. Turn right again onto Merriwood Rd. Follow directions from Merriwood Road above.

Announcing the 3rd annual...

**CIRCLE EIGHTS
AUTUMN LEAVES
DANCE** AT THE

**BOY SCOUT CAMP
IN ALPINE, NEW JERSEY
OCTOBER 27, 1996 at 2:00 P.M.**

with Bob Paris, Caller and Lois Bichler,
Country - Western Line Dancing
With "Shirley's" Square Dance
Shoppe open, Door Prizes
Galore and Circle 8's
famous food.

Beverly and John Hood
Autumn Leaves Dance Chairmen
(914) 356- 0791
Susan Jurgensen and David Wolin
Presidents, Circle Eights
(201) 525-0001

TICKETS PURCHASED IN ADVANCE - \$5.00

TICKETS SOLD AT THE DOOR - \$6.00



IN THIS ISSUE . . .

Advanced Classes	8	NNJSDA Calendar	4
Attention Club Presidents	60	NNJSDA Info Tel #	2
Beginner SD Classes	7	NSDC Early Bird	45
Callerlab	61	Non Member Club News	60
CCNJ	55	One Square Is Fair Awards	25
Club Ad Makers Info	16	Patron Awards.....	13
Dance Calendar	55	Plus Classes	8
Dear Readers	49	Presidents' Letter	3
In Memoriam	47	RD Classes	8
Legacy	4	RD Club News	56
Letters to the Editors	10, 58	Sewing CircleSquared	51
Maps NNJSDA Events	69	Sq Dance 800 Tel #	2
Mazziotti Column	53	Sq. Dancing Philly July 4	63
Member Club News Begins	12	Square View	50
NNJRDLC.....	57	Web Sites	20



Northern NJ Round Dance Leader's Council
presents the annual

Fall Festival of Rounds

Sunday, November 3, 1996
2:00-5:00 p.m.

VFW Hall, 6 Veterans Place, Elmwood Park, NJ
(See map on page 24 for Hix & Chix.)

Get your ticket from any NNJRDLC cuer.

Info: Raspa 201-896-1891 or Kushla 201-593-8440

ADVERTISERS' INDEX

Please tell our advertisers that you saw their ad in **Grand Square**.

Advanced Lessons ----	39	Harmony Dncrs	34	Red Bates	58
Al'e'Mo Sqs	64	Hi Taw Twirlers	38	Richmond Dancers ---	29
Bee Sharps	20	Hi Taw Plus Class----	17	RockAways	59
Belles & Beaux	24	Hix & Chix	23	Rockland Prom	62
B&B New Year's	10	Hunterdon Flut.....	16	Rockytops	30
Bolos & Petticoats ----	36	Ironia Reelers	21	Rutgers Prom	6
B-T Homecoming	43	Kings Sqs	54	See Saw Sqs	57
Circle Eights.....	14	Kittatinny Rangers ----	31	Shirley's SD Shop ----	48
CE Autumn Leaves ----	70	Lakeland Sqs	47	Spinning Wheels	9
Country Prom	32	Leisure Sqs	55	Sq Dance Videos ----	61
CP 2 Great Callers ---	22	M & M Sqs	11	Staten Sq Set	18
Cross Trail Sqs	27	Masqueraders	56	Tenakill Twrlrs	12
Dahl House	25	Mountain Sqs.....	35	Tumbling Leaves ----	46
Dingman Dancers ----	13	Myrtle Beach Balls ---	52	Turkey Trot Wknd ----	19
F.A.D. Sqs	26	Mystic Adventure ----	40	Valley Sqs	42
Friendly Sqs	41	NNJRDLC Fall Fest----	71	Warren Wheelers----	60
Get A-Rounds	28	NNJSDA-----3, 5, 37, 69		Western Wheelers----	53
Gotta Dance	44	NSDC	45	Y Squares	33
		Ocean Waves.....	15		

NNJSDA MEMBER CLUBS

See club articles (alphabetically A-Z) and ads for further information. Advertisers Index appears on inside back cover. Clubs desiring to change dance night or location **MUST** contact the Recording Secretary (listed on page 2) for Clearance.

Abbr: A=Advanced; Alt=Alternate; CW=Country & Western; MS=Mainstream; PL=Plus.

MAINSTREAM

PLUS

	Weeks of the Month:
Sunday:	
Al'e'Mo Sqs	2, 4 Sept-Jun
F.A.D. Sqs.	1, 3 Sept-Jun
Rockland Prom.	2 All Year
Monday:	
Spinning Whls	Every Wk. Sept-Jun 2, 4 Jul-Aug
Tuesday:	
Belles & Beaux	2, 4 Jun-Aug
Dingman Dncrs	2, 4, 5 Mar-Dec
Lakeland Sqs	Every Wk Sept-Jul
Wednesday:	
Belles & Beaux	1, 3 Sept-May
Thursday:	
Rutgers Prom.	2, 4 Sept-May
Warren Whlrs.	1, 3 Sept-Jun
Friday:	
Circle Eights	4 Sept-Jun
Hunterdon Flutterwh	1, 3 Sept-Jun
Kittatinny Rangers	2, 4 Sept-Jun
Ocean Waves	1, 3 Sept-Jun
Tenakill Twirlers	3 Oct-May
Y Squares	2, 4 Sept-May
Saturday:	
Leisure Sqs.	1, 3 Oct-Dec & Mar-May

	Weeks of the Month:
Sunday:	
Kings Sqs.	1, 3 Sept-Jun
Tuesday:	
Hi Taw Twirlers	1,3, 5 Sept-Jun
Wednesday:	
Cross Trail Sqs.	2, 4 Sept-Jun
Thursday:	
Hix & Chix	2, 4, 5 Sept-Apr Every Wk May-Aug
Valley Sqs.	1, 3 Sept-Jun
Warren Whlrs.	1, 3 Sept-Jun
Friday:	
Bee Sharps	2, 4 Sept-Jun
Hunterdon Flutterwh.	1, 3 Sept-Jun
Ironia Reelers	1, 3 Sept-Jun
Rockytops	1 Oct-Jun
Saturday:	
Country Prom.	2, 4 Sept-May
Harmony Dancers	1, 3 Sept-May
Leisure Sqs	1, 3 Oct-Dec & Mar-May
Richmond Dancers	2, 4 Sept-Jun
See Saw Sqs.	3 Sept-Jun
Staten Square Set	1, 3 Oct-Jun
Western Whlrs.	2, 4 Sept-Jun

ADVANCED

Sunday:	Wednesday:
Motiv8ors (A-2) 1, 3 some 5 Sept-Jun Every Jul-Aug	Mountain Sqs. (A-2) 1, 3, 5 Sept-Jun

DANCES CANCELLED

September:	October:	November:
1 - F.A.D. Sqs.	6 - F.A.D. Sqs.	27 - Cross Trail
4 - Mountain Sqs.	14 - Spinning Whls.	28 - Hix & Chix
19 - Valley Sqs.	25 - Circle Eights	Rutgers Prom.
20 - Hunterdon Flut Masqueraders		29 - Masqueraders

Leisure Sqs. & See Saw Sqs. are not dancing in September.
Tenafly Squares has suspended dancing.

*The Editors of **Grand Square** reserve the right to edit, correct, or otherwise modify articles or ad copy submitted for publication. Signed articles and letters are the opinions of the authors and not necessarily those of the NNJSDA.*