

Grand Square

OFFICIAL

PUBLICATION

NORTHERN NEW JERSEY SQUARE DANCERS ASSOCIATION
Vol. 38 - No. 3 Winter Issue Jan.-Feb. 1996

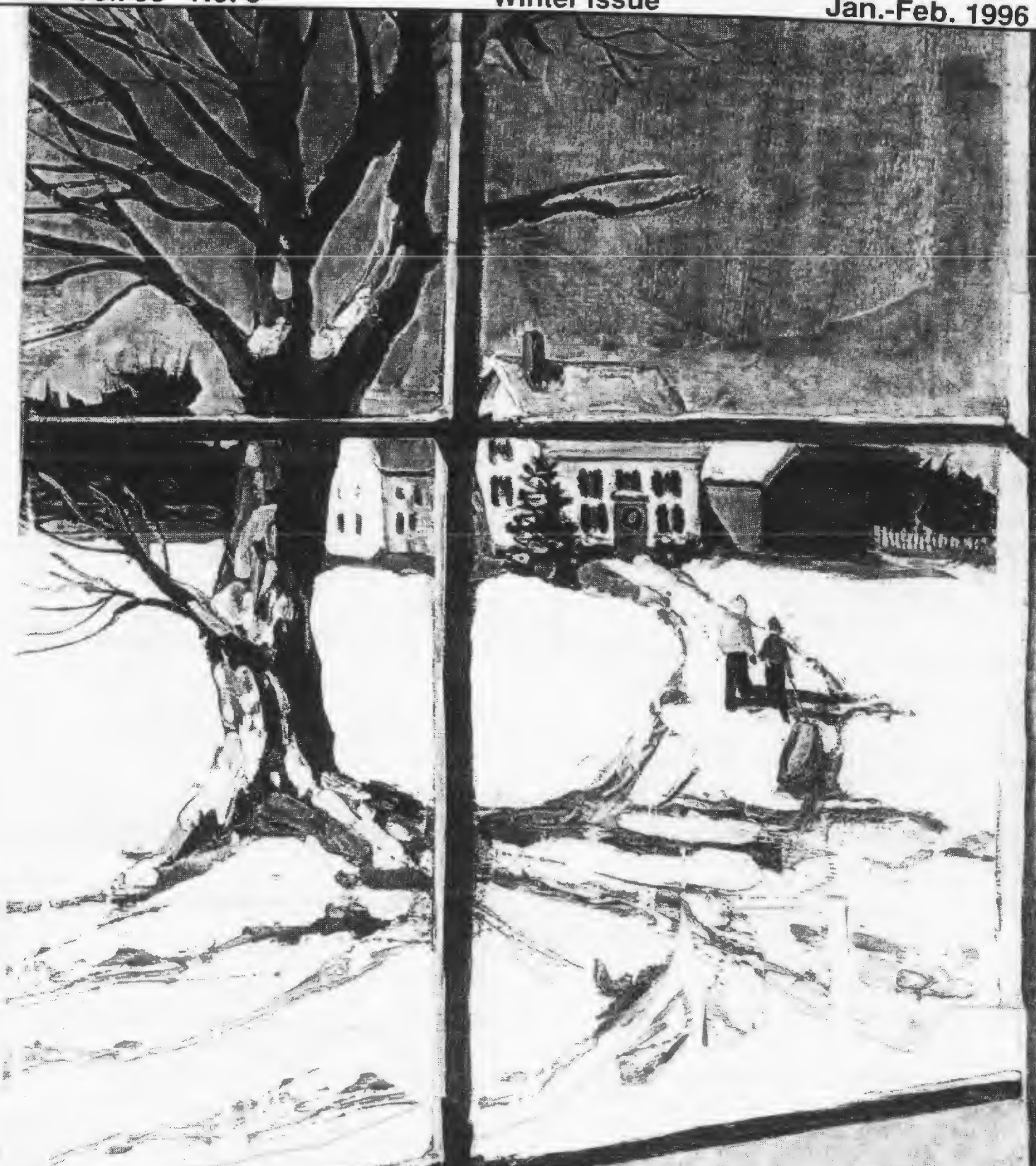

Grand Square

OFFICIAL PUBLICATION

EDITORS EMERITUS

Doc & Peg Tirrell

EDITORS

Charlie & Kathy Porter

99 Stanley Ave., Staten Island, NY 10301

Home: 718-448-9761

Kathy Office: 201-938-5517

Fax: 201-938-5466

FOR OVERNIGHT DELIVERIES ONLY

K. Porter/c/o Corcoran

15 Mohn Pl., Staten Island, NY 10301

ASSOCIATE EDITORS

Greg & Karen Kushla

201-593-8440

BILLING

Leo & Lois Bichler

718-356-2208

NORTHERN AREA REPORTER

Henry Shiman

201-866-0723

SOUTHERN AREA REPORTERS

Frank & Helen Cavanaugh

609-859-1937

WESTERN AREA REPORTER

Donna Poyer

908-852-9285

WESTERN AREA DISTRIBUTION

Bill & Erma Donaldson

201-627-7975

NNJSDA OFFICERS 1994-1995

PRES.-John & Joan Berg

21 Crescent Rd., West Milford, NJ 07480

201-697-2090

1st VPs-Sal & Mary Alessi

5 Villa Rd., Little Falls, NJ 07424

201-256-1647

2nd VPs-Richard & Rusty Ball

52 Kiel Ave., Kinnelon, NJ 07405

201-838-0312

3rd VPs-Gus & Marilyn Bachmann

258 Stevens Cr, New Milford, NJ

201-261-3921

REC. SECYS-Jean Koenig & Lillian Krov

228 Hillside Ave., Cranford, NJ 07016

908-276-8049

CORR. SECYS-Don & Fern Walker

873 Garrison Ave., Teaneck, NJ 07666

201-692-8350

TREAS.-Jim & Barbara Thoma

8 Wilson Ave., Staten Island, NY 10308

718-948-3056

201-697-2090 NNJSDA Information Line

1-800-892-8828 SD Info - Sponsored by the SDCNJ & Fed Del-Val SRD

PUBLISHED BI-MONTHLY SEPT-MAY

Circulation: over 2,000

Deadlines	Due Out:	Theme:
Jan. 17, '96	Mar. 10, '96	Grads
Mar. 17, '96	May 5, '96	Summer
July 17, '96	Aug. 31, '96	Fall
Sept 17, '96	Nov. 10, '96	Holiday
Nov. 17, '96	Jan. 19, '97	Winter

ADVERTISING RATES

Actual Size	NNJSDA	Non-
Necessary for	Member	Member
Camera-Ready Ads	Clubs	Advertiser
Full: 6"W x 10"H	\$52.00	\$57.00
1/2: 6"W x 5"H	26.00	31.00
1/4: 6"W x 2-1/2"H	13.00	18.00
1/8: 6"W x 1-1/4"H	6.50	11.00

Any ad submitted with dimensions other than listed above is not camera-ready.

Printer reduces copy by 25% when printing.

10% Discount for 5 prepaid ads, same size.

Ask Editors for details.

The following extra charges may apply:

Creating ad from rough copy	\$20.00
Corrections, sizing, etc.	5.00
Bills unpaid after 30 days	2.00

Make all checks payable to Grand Square.

Subscriptions: \$8.50 for 5 issues.

Send all ad copy, checks, articles, and subscriptions to Editors.

PRODUCTION STAFF

Sal & Mary Alessi, Leo & Lois Bichler

Karen Kushla

ASST. TREAS.-

Harold & Maureen Latham

82 Hilltop Ct., Clifton, NJ 07012

201-779-6670

PAST PRES.- Dick & Shirley White

40 Lakewood Dr., Jaffrey, NH 03452

603-532-7327

COMMITTEE CHAIRMEN 1995-1996

ADVISORS-

Jim & Joyce Kelly - 908-658-4271

BLOOD BANK #9192

Donna Anderson - 718-727-5141

CCNJ LIAISONS

Margaret Guyre - 201-384-2791

& Donna Brady - 201-387-1135

INSURANCE-

Fred & Kathryn Hill - 908-849-1606

NNJRDLC LIAISONS-

John & Madelyn Kerner-201-384-5407

SDCNJ LIAISONS-

Norman & Audrey Bolin - 201-729-9327

NJ STATE OUTFIT-

Rusty & Richard Ball - 201-838-0312

From the desk of..... **JOHN & JOAN BERG, NNJSDA PRESIDENTS**



This past November over 80 squares attended the NNJSDA Mini-Festival. We hope you had the opportunity to dance to Jerry Storey, Mike Jacobs, and Mark Franks. From all those who attended, we were told that they truly enjoyed themselves and the calling was outstanding. We're sure that the round dancers enjoyed Ron & Ree Rumble. How about that dance number they did? Wasn't it enjoyable? And then, of course, we had the exceptional dance routine by the Red Rose Exhibition Team. They are truly a credit to New Jersey.

In order to bring you such a spectacular event, it takes the work of many people. We would like to thank Norman & Audrey Bolin, past NNJSDA Presidents, for the outstanding job they did as Registrars. It is not an easy job to register over 650 people for such a dance. Also, we would like to thank the entire NNJSDA Executive Board for all their help, understanding, and patience required to undertake such a task. A very special THANK YOU to the members of Rockland Promenaders for handling the water jugs.

As we write this article, the snow is falling outside our window, reminding us that winter is here. We understand that several clubs already have had to cancel dances due to the weather. Remember to call a club member in case of inclement weather to be sure that the dance is being held.

While we are discussing dances, we are starting to see some dancers are beginning once again to dance in "pre-formed squares." We have found through the years that nothing hurts a club's reputation more than being known for "pre-formed squares." Remember that the dancer you just bumped from your square is a dancer your club will probably never see again. This becomes especially

Please turn to page 4

**NORTHERN NEW JERSEY SQUARE
DANCERS ASSOCIATION**

Mid-Term Class-Level Dance
Sunday, January 28, 1996
2:00 - 5:00 PM

Caller: DICK MAZZIOTTI

Location: Lincoln Park Community Center
Rt. 202 (Main St.) & Chapel Hill Rd., Lincoln Park, NJ.

Sponsored by the Association for all Students, Angels,
Teachers, Class Coordinators, and Club Members.

Soft-soled shoes required.
Wear your name badge.
Map and directions on page 69.

NNJSDA

For information call:
Rich & Rusty Ball 201-838-0312
John & Joan Berg 201-697-2090

NNJSDA CALENDAR

January:

- 17 **Grand Square** Deadline
- 21 Delegates Meeting
VFW, Elmwood Park, NJ
Grand Square Distribution
- 28 Mid-Term Student Dance
Mazziotti
Lincoln Park, NJ

March:

- 10 NNJSDA Exec. Bd. Mtg.
Grand Square Distribution
- 17 **Grand Square** Deadline
- 30 NNJSDA Special (PL)
Callahan/McGee
Lincoln Park, NJ

April:

- 20 10th NJ Convention
Trenton State, Ewing, NJ
- 28 NNJSDA Spring Fling
(Student-Level)

May:

- 5 Delegates Meeting
VFW, Elmwood Park, NJ
'96-'97 Questionnaires Dist.
Grand Square Distribution
- 31 NNJSDA Special (PL)

June:

- 2 NNJSDA Exec. Bd.
Changeover Mtg.
- 15 '96-'97 Questionnaires due
back to Grand Square Editors
- 26-29 NSDC, San Antonio, TX

July:

- 10 NNJSDA Summer Dance
(MS/PL after tip)
- 17 NNJSDA Summer Dance
(MS/PL after tip)
Grand Square Deadline
- 27 Summer Super Blow Out
(Alt MS & PL/ A-1 aftertip)

'ONE SQUARE IS FAIR'

Presidents' Letter continued from page 3

more important as last year's graduates are beginning to circulate among the clubs.

As we enter the New Year, many new students will be attending student-level dances at our local clubs. This is an important time for them and us. We have to make them feel comfortable. It is the time for us to welcome them to the "Wonderful World of Square Dancing." There is no better way to welcome them than at the NNJSDA Mid-Term Dance on Sunday, January 28, 1996, at the Lincoln Park Community Center. Let's make this one of the year's highlights. Remember, these students are the future of square dancing.

While your marking January 28th on your new 1996 calendar, also take a moment to mark down March 30, 1996. That's the Saturday evening that Mike Callahan is calling and Mary McGee is cueing for our March Special. Remember all 35 clubs are expected to participate with one square or more. There are many other important dates; please take a few minutes to browse through the NNJSDA Calendar on page 4 and jot them down.

Joan and I wish each and everyone a happy, healthy, and prosperous New Year, and hope we have the pleasure of dancing with you this year. Square 'em up!

John & Joan Berg, NNJSDA Presidents

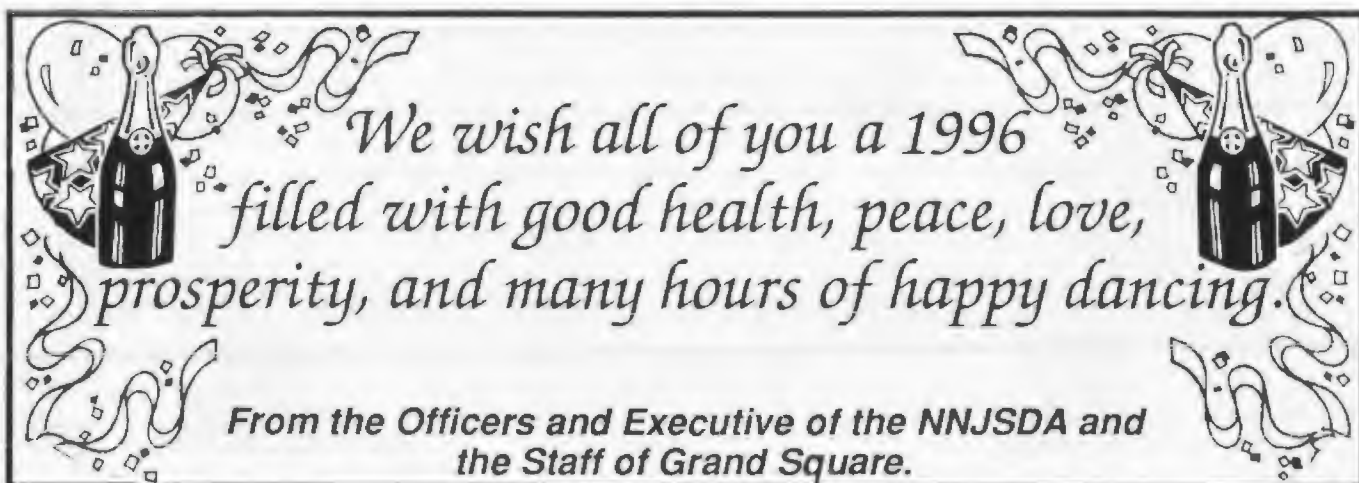

NORTHERN NEW JERSEY SQUARE DANCERS ASSOCIATION

Presents

National Caller
Plus Program
A-1 after tip

Mike Callahan

Cuer from PA.
on Rounds

Mary McGee

Dance Date

Saturday, March 30, 1996
8:00 - 10:30 P.M.

Location

Lincoln Park Community Center
Route 202 (Main Street) & Chapel Hill Rd.
Lincoln Park, NJ

Dress Code

**Square Dance Attire & Soft Sole
Shoes Required.**

One Square is Fair

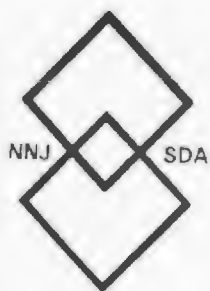

All Clubs Expected
to Participate



Map and directions on page 69.

Inquiries

Sal & Mary Alessi
(201) 256-1647

John & Joan Berg
(201) 697-2090

The Gathering.

October 6, 1996.



GABE DELL'ANGELO

It is with great sadness that we report the death of Gabe Dell'Angelo on Sunday, December 24, 1995. Gabe died at home with his wife, Sila, at his side after a valiant battle with cancer.

Gabe & Sila were Presidents of the NNJSDA from 1981-1983, and served on the Board for more than 10 years in various roles including, Treasurers, 3rd Vice Presidents, 1st Vice Presidents, and Advisors. They were also active members of Staten Square Set and served as Presidents from 1976-1977. These facts hardly tell the story behind a couple who loved square dancing, carried that love with them everywhere, and gave it freely to everyone.

Always great supporters of the NNJSDA, they regularly attended all NNJSDA functions, and every year the new graduates had the pleasure of dancing with them nearly all summer long. A staunch champion of all new dancers, Gabe & Sila encouraged students to continue dancing, and welcomed any and all into their square.

They served on committees for both the Atlantic City National Convention in 1977 and the Baltimore National Convention in 1984. Staten Square Set recognized their contributions to square dancing when they were awarded the Lucarini Award, named after Gene & Grace Lucarini, also former NNJSDA Presidents. To be eligible for the Lucarini Award, you had to be in a leadership role for a minimum of ten years.

Never one to rest on their laurels, they remained active and vital members of Staten Square Set, chairing the anniversary dances, installation dinners, and nominating committees. They were awarded the Blue Jay for service to Staten Square Set. Gabe & Sila were regular visitors at all the other Staten Island clubs and continued to be angels at RIOS classes.

As green students, Charlie and I were encouraged by Gabe & Sila even though we would not be joining their club after graduation. They took us under their wings and became our mentors. We have sought their counsel many times over these past 10 years. When asked to join the Executive Board of the NNJSDA just a year after graduation, they spent many hours helping us make our decision. When we accepted editorship of *Grand Square*, they offered to help us in way they could.

His hundreds of friends will miss him terribly, especially that impish smile and that special gleam in his eye when he was about to reduce everyone in the square to laughter. He was one of the best advertisements square dancing ever had. He wore that love on his sleeve for all to see. Our loss is heaven's gain. Gabe has been an angel for many years, but now he truly has his wings.

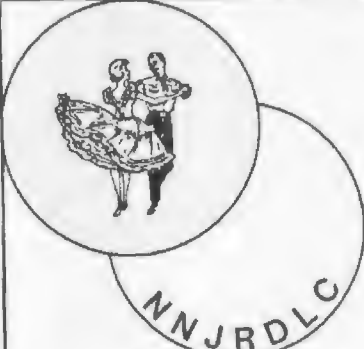

Northern NJ Round Dance Leader's Council
presents the annual

Spring Festival of Rounds

Sunday, March 3rd, 1996
1:00-5:00 pm

VFW Hall, 6 Veterans Place, Elmwood Park, NJ

Get your ticket from any NNJRDLC Cuer.

Info: Gotta 908-249-2086 or Kushla 201-593-8440

LETTERS TO THE EDITORS . . .

The recent rash of letters pointing fingers or complaining about the rise and fall of dancing, clubs and/or dress leads me to add my comments. In the recent issue of *National Voter* an article entitled "Bowling Alone" the point is made that Americans are no longer joining groups to actively participate. Our direct engagement in politics, civic organizations such as the Red Cross, PTAs, or LWVs, union membership, and even attendance at church has dropped significantly. People are disenchanted with organizations even though they embrace the philosophy. There are many new associations which are vital and growing such as the environmental watchdog groups or retired citizens protecting Medicare, but these memberships are supported by money and emotions, not by regular attendance. The point of the article is that even in a recreation such as "bowling," league participation is way down and individuals who go bowling sporadically for a causal night out with friends is up.

Does this sound like square dancing? People want to "try" square dancing for a while but not to join a club; people want to "try" a festival or a weekend but not travel very far. Of course there are exceptions. The Mini-Festival was very well attended with great traveling callers, but what about the home clubs? In the main, people are doing their own individual thing without taking the responsibility of active group membership. In conclusion, it is not **just** square dancing that is suffering; there is a whole nationwide pattern.

I am not offering this as an alibi, but as a reason. Now my hope is that we all take a look at what we are doing. Let us help CLUBS, join, promote, and enjoy being an active participant of a group and counteract this national tendency to do our own thing.

Freddie Kaltenthaler

Please turn to page 9

Belles & Beaux

1996

4 student dances scheduled !!

Belles & Beaux again looks forward to welcoming student dancers to our annual series of student level dances! Please join us on the following Sunday afternoons, from 2-5p.m:

January 14
Dick Mazziotti
&
Dot Loewenstein

February 11
Dick Mazziotti
&
Pal Johnson

March 10
Dick Mazziotti
&
Don Coy

April 14
Dick Mazziotti
&
Andy Woerner

These dances are held at the Glen Rock Community Church, corner of Rock Road and Hamilton Avenue, Glen Rock. Questions? Call Margaret, (201) 384-2791 or Rich (201) 838-0312 or Dick (201) 664-4432.

Watch for our flyers for further details!
soft-soled shoes – please!





Callers Council of New Jersey

Presents the 22nd

Annual Spring Dance

Class Level Dance

Sunday February 25th

2:00 - 5:00 PM

Glen Rock Community Church - 354 Rock Road - Glen Rock NJ

see any CCNJ caller for tickets

info (201) 433-9673

LETTERS TO THE EDITORS continued from page 8

Whenever a club folds, it is usually because it is no longer financially able to continue. Bottom line is that the income is no longer enough to balance expenses. Typically, declining numbers of attendees and increasing costs do not make for a happy ending. I would like to address two of the issues (there are obviously more) which contribute to this dilemma, the cost of admission to the dance, and the cost of the callers/cuers.

First, the cost of admission. I went through a *Grand Square* from 1968 and found the average cost for advertised dances was \$1.50 per person. In the September 1995 issue of *Grand Square* the average cost per person was \$3.25, an increase of 117%. How does that compare with other costs over the same period. Cars: \$4,000 to \$12,000, up 200%; houses: \$25,000 to \$150,000, up 500%; movies: \$1.00 to \$6.50, up 550%; gasoline: \$0.30 (per gal.) to \$1.30, up 333%; bowling: \$.33 (per game) to \$1.50, up 355%. Please note that these figures are per my recollections and do not reflect extensive research. It would appear that the cost of a dance has not kept pace.

Also, what are you getting for your \$3.25 per person? Typically, you are getting two and one-half hours of entertainment by a licensed professional, the social interaction that a dance atmosphere created, and refreshments. All this for about \$1.30 per hour. Go watch a movie for two and one-half hours and it will cost you \$2.60 per hour and you don't get refreshments.

A large part of the appeal of square dancing has always been its relative low cost. I think this should still be one of our goals, but I think that we have to be realistic with our pricing. Charging \$4 or \$5 per person for a dance is not unrealistic. Will this cause fewer clubs to fold? No, only increased attendance

Please turn to page 63

This season club news will be alphabetical order from A-Z.

AL'e'MO SQUARES -- Brooklyn, NY

MS/PL tips

2 & 4 Sun. Sept-June

Ft. Hamilton Comm. Rec. Bldg., Ft. Hamilton

Good news and sad news to report in this issue! Sad news: Charlie & Sue Ludsky have resigned as Presidents after almost two years at the helm. Personal and health reasons have made them relinquish their post. They ran Al'e'Mo by the slogan of the club, "The Sharing and Caring Club." They always used this motto as their guide in making decisions for the membership. They were instrumental in establishing a contact for a Battered Women's Shelter. They encouraged the dancers to make contributions to the Cystic Fibrosis Organization. They induced us to make a donation to the victims of the Oklahoma disaster. They initiated the "Toys for Children" at the Battered Women's Shelter. During their term we saw the club grow to new heights. All this with "The Sharing and Caring" concept. We all wish them the best that this world has to offer and we will continue to dance together.

The good news: We have two dynamic personalities that will make you sit up and take notice! Vincent Nunziato and Caroline Parlato were 1st Vice Presidents and they stepped up to take over the leadership. Both have been involved with the organization for many years and their time has come. They both have many accolades in their resume to make you know that they will do a superb job. We're all behind them with well wishes and we offer them all the help that they will need, without missing a step, in the operation of the club. **Best of luck, Vincent & Caroline!**

Ad on page 16

Joe & Phyllis Piazza

718-435-4631

718-376-3149



Tenakill Twirlers

BRYAN SCHOOL, Brookside Avenue, CRESSKILL, N.J.

MAINSTREAM WITH ONE PLUS TIP

THIRD FRIDAYS

Squares from 8:00-10:45 P.M.

Cuer - Nick Raspa

Jan. 19	Don Coy
Feb. 16	Howard Richman
Mar. 15	Don Coy
Apr. 19	Howard Richman
May 17	Dick Mazziotti

Proper S/D attire and soft-soled shoes are required on our beautiful wooden floor.

Presidents:
George & Fanny Meyer
201-385-3263

Welcome back to square dancing, Harry & Olive Graveman.

BE A NJ CONVENTION DIPLOMAT!

The NJ Convention Publicity Committee is asking for your help by acting as our diplomatic representative. We'll give you flyers and a very short personal invitation for you to ask to have issued during announcements. Contact Laurie Mazziotti 201-664-4482. Thanks for helping make the 10th a great Convention.

ROCKYTOPS 
PLUS LEVEL DANCING WITH A-1 AFTERTIP

*First Friday of Month -- Rounds at 8:00pm -- Squares from 8:30 to 11pm
 United Methodist Church -- John Street at Franklin Avenue -- Pearl River, New York*

Friday, February 2	MIKE CALLAHAN	NY
Friday, March 1	MARK FRANKS *	NJ
<u>Saturday</u> , April 6	RANDY PAGE **	CT
Friday, May 3	BRIAN FUGERE	NJ
Friday, June 7	TIM CRAWFORD (Special - No Raids)	Canada

ROUNDS BY NICK AND CAROLE RASPA

**March 1, 1996 dance will be held at Old Stone Church Education Center, Upper Saddle River, NJ*

*** April 6, 1996 dance will be held at Beth Am Temple, Pearl River, NY*

For Further Information, Please Call:

Eileen & Larry	(914) 362-1924	Roz & Ron	(201) 664-9356
Sandy & Art	(914) 352-7631	Beverly & Marty	(201) 391-3592

BEE SHARPS -- Somerville, NJ

PL

2 & 4 Fri. Sept-June

St. John's Episcopal Ch., 158 W. High St.

Congratulations to Kathy & Dan Koft on the birth of their first baby. We wish them every happiness. Kathy was scheduled to cue for us on October 13, but "Julie," their bundle of joy, couldn't wait any longer for her grand entrance. She arrived on October 12, ahead of schedule. Fortunately, Kathy arranged for a substitute in the event she was unavailable. Friday the 13th would have been an unlucky day to have a dance without a cuer, but thanks to Dave Roberts the day was saved. Special thanks also to Warren Wheelers who raided that dance.

Walt & Rowena Sydor have had to give up dancing for health reasons. They both have a great love of square and round dancing. They've spent a lot of time and energy being Class Coordinators of our square dance class, a Plus workshop and a round dance class. Walter even did some round dance teaching. They were always ready to help our club. We want to publicly thank them for everything they've done for Bee Sharps especially for getting our wonderful dance hall at St. John's Episcopal Church and Adamsville School for our classes.

We've enjoyed raiding Valley Squares, Merri Eights, and Hix & Chix so far. It's always a pleasure visiting neighboring clubs in the Association. We're looking forward to your club raiding us soon. Hope everyone enjoyed the holidays.

Ad on page 19

Irma & John McCarthy

908-722-3565

BELLES & BEAUX -- Glen Rock, NJ**MS/PL tip****1 & 3 Wed. Sept-May****Coleman School, 100 Pinelynn Rd.****2 & 4 Tues. June-Aug.****VFW Hall, 6 Veterans Pl., Elmwood Park**

By this time your holiday hustling and bustling is over, and, hopefully, you've settled back into your square dancing schedule. Hope your holiday was the best. Are you ready for the "quiet" part of winter?

B&B's post-holiday celebrations were super this year. Our combined pie night, pie auction and Thanksgiving food drive and turkey 'n trimmings raffle were a big success. Many members baked many pies for selling and for eating, and members and guests were super-generous in helping us to stock the local food pantry.

Extra-special was this November night with another special event. We honored charter member Ken & Edna Franz and Bill, Agnes (in memoriam) and Betty Edwards by bestowing life membership for their dedication to Belles & Beaux these past 16 years. Bill isn't feeling well these days, and I'm sure would appreciate any notes from old friends, as would Betty, who is staying home to care for her Dad. Ken & Edna still actively participate in our activity, both at our dances and angeling our class. These are truly special friends and very deserving of this honor.

Speaking of our class--they're really doing well! We're looking forward to their attendance at our first student-level dance in December, and our four monthly specials starting in January. Hope you--student and angels--will join us too!

Those square dance license plates are still attracting attention. A few days ago I was paying the attendant at the gas station when a young man poked his head at my window and said he noticed my plates. He used to do some work for a square dance couple in Bergen County who moved to Vermont. Did I know the Tirrells? The Tirrells moved after I started dance, so, of course, I knew them. He asked me to say hello to them for him when I could. So, short of waiting 'til convention time: Tirrells, "Hello from Larry the painter!"

Ad on page 25

Margaret Guyre

201-384-2791

Y SQUARES

2 & 4 Fridays**Carl Kumpf School, Mildred Terrace, Clark, NJ****7:30-8:00 p.m. Rounds****8:00-10:30 p.m. Squares & Rounds****Soft-soled shoes required.**

January 26th.	PIZZA NIGHT Caller: BRIAN FUGERE	Cuer: KAREN KUSHLA
February 9th.	SWEETIE PIE NIGHT Caller: BRIAN FUGERE	Cuer: KAREN KUSHLA
February 23rd.	RED, WHITE and BLUE Caller: BRIAN FUGERE	Cuer: KAREN KUSHLA
March 8th.	GREEN STUFF Caller: BRIAN FUGERE	Cuer: KAREN KUSHLA

Direction to Carl Kumpf School: GSP exit 135; west on Central Ave; at 1st light, left on Raritan Rd; at 3rd. light turn left onto Madison Hill Rd. Third street on the right is Mildred Terrace; half block to school entrance on left.

Information:	Alice and Bill Lambert	908-382-2070
	Barbara and Harry Gerus	908-755-5529
	Hall Phone	908-574-8354

BOLOS-N-PETTICOATS

We have moved
to a new location
You can find us
at
192 Union Blvd.
Totowa, NJ 07512

Business Hours:
by appointment only

(201) 904-0424

Frank & Brenda
WE ACCEPT CASH OR CHECKS
- NO CREDIT CARDS

DIRECTIONS:

Traveling Route 80 West - exit 55B (Union Blvd, Totowa).

Traveling Route 80 East - exit 53 to Rt 46 East to Union Blvd, Totowa.

Follow Union Boulevard (north) about 1 1/2 miles to #192 on the right. Park in the rear.

Look for our shop at upcoming dances:

CCNJ Dance Feb 25th

NJ State Convention April 20th

WILLOWBROOK MALL

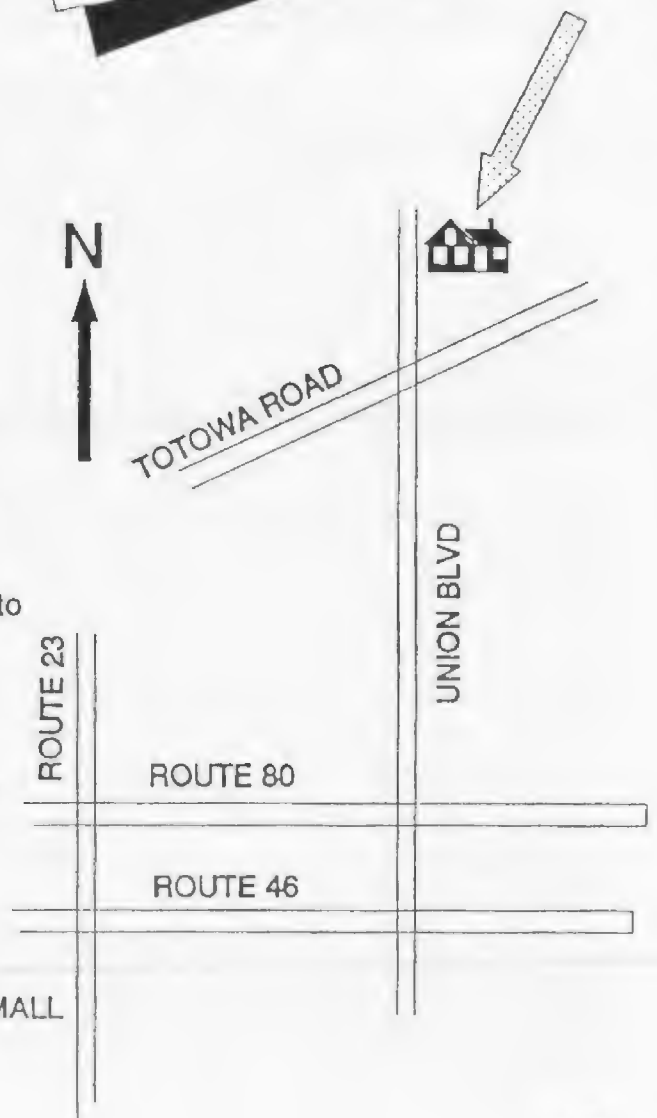

Western Wheelers S/D Club

THE REFORMED CHURCH of ORADELL 641 Church Street @ Kinderkamack
 Oradell, N.J. Hall 201-261-1720 2nd & 4th SATURDAYS
 Pre-Rounds 8:00 PLUS DANCING 8:30-10:45 "A" After Tip
 Info. 201-261-3921, 569-9120 or 914-352-0627 Nick Raspa, Club Cuer

January 27th, 1996 T-riffic Tees Roy Leber
February 10th, 1996 Randy Page
February 24th, 1996 Mardi-Gras Fun Roy Leber
March 9th, 1996 Silent Auction Dick Mazziotti
March 23rd, 1996 Roy Leber

April 13th, 1996 Remember When John Kaltenthaler
April 27th, 1996 Don Coy
May 11th, 1996 Randy Page
May 25th, 1996 International Night Marvin Northrup
June 8th, 1996 John Kaltenthaler

Second & Fourth Saturdays: Western Wheelers

COUNTRY PROMENADERS -- Edison, NJ PL
2 & 4 Sat. Sept-May Stelton Comm. Ctr., Plainfield Ave. (Rt. 529)
Alt. Site: 1st Presby. Ch, Miln St. & Springfield Ave, Cranford

We hope everyone had a happy, healthy, and fun Holiday season. We have been very busy spreading the Country Promenaders' cheer over the last several months. At the end of September, we put on a demo at the Fall Festival of Fireworks in Edison. A beautiful sunny day added to the enthusiasm of the 2+ squares of dancers. With caller Herb Conklin's help, we encouraged the audience to join us, bringing us to five squares in all.

In October, we raided Merri Eights, and Y Squares for their Halloween Dance. Have you every played Simon Sez while square dancing? It's a lot of fun. Ask Brian Fugere the next time you are dancing at a club where he is calling. November 11th was our 43rd Anniversary Dance. Mike Callahan (NY) called to an exceptional turn-out of appreciative dancers, especially considering the severe storm we were experiencing that night. Mike always kept the whole floor moving with his fun and different choreography. Then our members recovered in time for the Mini-Festival the next day. Isn't that Jerry Story something?

IMPORTANT REMINDERS: We will have a guest cuer at our **February 10th** dance, Al Spinks, when the dance is held at the **1st Presbyterian Church of Cranford** (see map on page 17 of the September/Fall Issue of **Grand Square**).. That evening you will also enjoy the choreography and singing of Brian Fugere, and the gastronomic delights of Pie Nite. Also, have you started planning your costume for Carnivale on the 4th Saturday in February? We wonder what Tim Marriner will wear? Hope to see you there.

Ad on page 26

Jan & Louis Thompson

908-577-9413

CROSS TRAIL SQUARES – Caldwell, NJ

PL

2 & 4 Wed. Sept-June

Lincoln School, Crane St.

Cross Trails is swinging into the winter season with a new student class being shepherded by Andy Woerner and a merry band of angels. The class meets every Tuesday at the Grover Cleveland School in Caldwell and, just as in real life, you can never have too many angels.

The club has been busy with its array of theme dances as there seems to be no holiday that we can't convert into a square dance event. The club was out on the demonstration circuit again with an appearance at the Caldwell street fair. We were as always on the lookout for new friends and new dancers.

Club members have been traveling and raiding with great enthusiasm this year. Cross Trails dancers have gone to dance weekends in New Hampshire; the Catskills; Mystic, Connecticut; and the Mini-Festival in Bridgewater, NJ. The club also had a long-range raid to Leisure Squares in PA. In true Cross Trails fashion, most of the raiders prepared for the long drive by attending the Harvest Home Supper first. It isn't only the army that travels on its stomach.

The Square Wheelers, Cross Trails intrepid camping division, ended their season with a fall foliage trip to Upper Black Eddy, PA. They will spend the winter square dancing and getting everything set for next season's adventures.

While we all wait for spring, we at Cross Trails know that a couple of tips and some good friends are guaranteed to keep you warm. So come join the dance.

Ad on page 39

Frank & Alice Lemire

201-783-1683

TENAFLY

SQUARES

Mainstream Dancing
The Second Friday
Of Each Month
8:00-10:30 P.M.

St. Luke's Church
Mass. Ave &
Knickerbocker Rd.
Haworth, NJ

February 9

Manny Amor

Sweetie Pie Night

March 8

Don Coy

*Class Level Dance
Students \$2*

April 12

Mickey McFarland

*Treasurer's Night
Treasurers Free*

May 10

Howard Richman

*Pot Luck Supper
A Dish For 6
New Grads Welcome
6:30*

June 14

Bob Barassa



ROUNDS BY NICK RASPA

Information: John and Betty (201)666-8937 John and Madeline (201)384-5407

DINGMAN DANCERS -- Milford, PA

MS/PL tip

2 & 4 Tues. Mar-Dec

Delaware Valley H.S., Routes 206 & 6

Dingman Dancers is on hiatus until March 12 when they will hold their Welcome Back Dance.

Days: 201-460-1700 x211

Ad on page 18

Bill & Jean Gannon

717-296-4436

Al "e" Mo Squares

Ft. Hamilton Army Base
Community Center
(entrance on 101st Street)
7:30 pm- 10:00 pm

DATE	CALLER	THEME
Jan 28	Andy Woerner	Puzzle Festival
Feb 11 (s)	Gerry Hardy	Valentine Day
Feb 25	Nick Martellacci	Winter Festival

(s) denotes STUDENT WELCOME

Soft Sole Shoes Only, Please

For Info: Please Call

Vincent @ 718-615-1507

Caroline @ 718-745-3793

Admission \$ 4.00 p/p

The Best Club with the best Callers



Mainstream with Plus tips

F.A.D. SQUARES -- Paramus, NJ**MS/PL tips****1 & 3 Sun. Sept-June****Paramus Congreg. Ch, 205 Spring Valley Rd.**

Happy Birthday to Vera Calmpet (Jan. 22), Dick Dexter (Jan. 28), and Mickey Orsages (Jan. 29), with many more years of dancing ahead for all.

Happy New Year to everyone, as we look forward to F.A.D.'s upcoming 13th Anniversary in April. We recall creating this club in 1983 as a "Basics" club, to bring back dancers who had dropped out for various reasons. Twenty-two dancers formed the nucleus, and among those Charter Members is our current President, Dorothy Fels. Of course, it goes without saying that Daisy Orlove was also a Charter Member, and still comes to as many dances as possible.

Our Monday class at the Ridgewood "Y" has ended, having lost 4 of our 5 students, and the 5th student has moved over to Circle 8s, where she was warmly welcomed. Angeling her is our prior-year student, Walt Rahuba. Look for Reete Cusumano on the dance floor at student dances. She's a ball of fire! Our Thursday class in Midland Park attracted two couples from Franklin Lakes, who are excellent dancers. We want to thank ALL our Angels, who have helped and are helping with our classes, as well as our faithful Class Coordinators, Joe & Eleanor Emmerich, who have put in many hours--tremendous support from the club. THANK YOU!

It's been decided that "Ocean Wave" is the preferred call since many of our members love to go cruising. Hmmm...wonder is that's how the call got its name? We offer something for everyone, from Mainstream through Plus (2 tips) as well as Line Dancing (taught during breaks). Of course, socializing is also important--some of our dancers never get out of the kitchen. So, come on down and have Fun At Dancing with F.A.D. Squares.

Ad on page 44

George Loewenstein

201-797-1934

K's Advanced Workshoppers**Duffey School, Central Ave, Wharton, NJ****Mondays beginning at 7:30****A-1 7:30 - 9:00 / A-2 9:00 - 10:15****For more information call****Bill Beebe (201)335-0127 or****John Kaltenthaler (717)646-2945****HARMONY DANCERS -- Springfield, NJ****PL****1 & 3 Sat. Sept-May****Chisholm Sch., S. Springfield Ave. at Shunpike**

Harmony Dancers have had a very good beginning this year. We have had several raids with good turnouts, and have met our "One Square Is Fair" requirement at the Association dance and the Mini-Festival. The Mini-Festival was a great day of dancing and we stayed until the music stopped. Several clubs have raided Harmony Dancers and we always welcome their visits.

Holiday time is fast approaching as I write this and although it will be past holiday time when you read this, we sincerely wish everyone Happy Holidays and a Healthy and Happy New Year to all.

Ad on page 64

Wayne & Kay Schroeder

908-396-8286

Worry, whatever its source, weakens, takes away courage, and shortens life.

John Lancaster Spalding

DINGMAN DANCERS

Square dancing in the northern Poconos

Rich Murphy, Club Caller
2 & 4 Tuesdays

Mainstream with Plus tip
7:30-9:30 pm

Delaware Valley High School Cafeteria
Routes 206/6, just north of Milford, PA

We do not dance during January and February.

Mar. 12 - Welcome Back

Mar. 26

Apr. 9

Apr. 23

For information and directions:

Bill & Jean Gannon

717-296-4436 Days: 201-460-1700 x211

Ray & Carol Proulx

717-296-7645

HI TAW TWIRLERS -- New Milford, NJ

PL

1, 3, 5 Tues. Sept-June

New Milford Middle Sch., Roslyn Ave.

Our square dance season is in full swing now and many couples, including the Pangborns, Ileans, and Muldays, have returned from their summer safaris and summer retreats. We are delighted to welcome them back again. At each Plus dance, the caller has offered a "mini-workshop" on all-position calls so that dancers are better prepared for the next program of dancing.

Please join us for a Plus dance "extraordinaire" whenever you can. The welcome mat is always out!

Ad on page 54

Caroline Sutton

201-262-0616

CLUB AD MAKERS INFORMATION

Cover these dates in your ads for the upcoming issues:

Issue:

Deadline:

Dances Between:

Graduates

Jan. 17

Mar. 10 to May 30

Summer

Mar. 17

May 5 to Sept. 30

Fall

Jul. 17

Sept. 1 to Nov. 30

HIX & CHIX -- Elmwood Park, NJ

PL/MS

PL - 2, 4, 5 Thurs. Sept-Apr

VFW Hall, 6 Veterans Place

Every Thurs. May-Aug

They say time flies when you're having fun. Well, we must be having lots of fun, because it seems like we just finished a *Grand Square* article and here we go again. Well, the truth be told, Hix & Chix square dancing has been lots of fun this fall. Thanks to Howard Richman, Sandy Corey, Randy Page, and Steve Forman. We even gave Nick Raspa a night off and enjoyed Regina Wagenhoffer's cueing.

Our September Fest was shy on beer and polkas, but long on cider, hot dogs with all the fixins, and great dancing. Halloween brought out two lovable, roly-poly ghosts, contrasted by the black sparkling costumed Spanish Dan and Senorita. Cleopatra was enchanting in her long black wig, escorted by the dashing and debonair Don Juan. Never did find out what the Dutch girl had in those buckets she was carrying on her yoke. Bet it wasn't milk! Then there was the cute little blond girl with the big red-headed doll (the girl apparently needed glasses because she came and left with some well-worn hobo). There are always a couple of cards at any good party and ours was no exception. We had the King of Spades and the Queen of Hearts.

Ad on page 47

Dick & Brenda Dexter, 2 overripe pumpkins

201-529-3372

**HUNTERDON FLUTTERWHEELS -- Stanton Sta., NJ Alt MS/PL
1 & 3 Fri. Sept-June Echo Hill, Lilac Drive**

The Hunterdon Flutterwheels were very happy to get back to their dancing at their regular hall at Echo Hill Park. Our first dance was a big success. Dalt Young called for us and we have five squares. We want to thank all of you who came regularly and helped support us until we could get back. We love you all.

The surprise of the night was when our President Stan Tempsick asked all the ladies to line up so he could get kisses because it was his birthday. However, he never did tell us how old he is.

We have already gotten a good start on our raids and we have also done several demos. Many of our members are learning to round dance. Our cuer, Peg Dockry, teaches early rounds before our dances. Everyone is having such a good time and it is so nice to have Peg. She is so sweet.

Congratulations go to Ruth & Harry Schmidt. They have a beautiful new granddaughter. Our club is a fun club and we love having visitors. Please come and dance with us. See you in a square.

Ad on page 22

Lillian Davis

908-722-1747

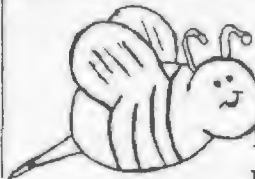



BEE SHARPS OF SOMERVILLE



1995-1996 SEASON
PLUS LEVEL DANCES

EARLY ROUNDS - 7:30 PM
SQUARES - 8:00-10:30 PM

EVERY 2nd and 4th FRIDAY





DATE			THEME
JAN. 26, 96	MARION PEARCE	RUS BOOZ	
FEB. 09, 96	AL KAESLER	DAVE ROBERTS	PIE NIGHT
FEB. 23, 96	DICK MAZZIOTTI	AL SPINKS	
MAR. 08, 96	DALT YOUNG	DAVE ROBERTS	ST. PATRICK'S
MAR. 22, 96	JIM SNYDER	NICK RASPA	

**** WOODEN FLOORS ****
SOFT SOLE SHOES A MUST

DANCES HELD AT:
ST. JOHN'S EPISCOPAL CHURCH
158 WEST HIGH STREET
SOMERVILLE, NJ 08876

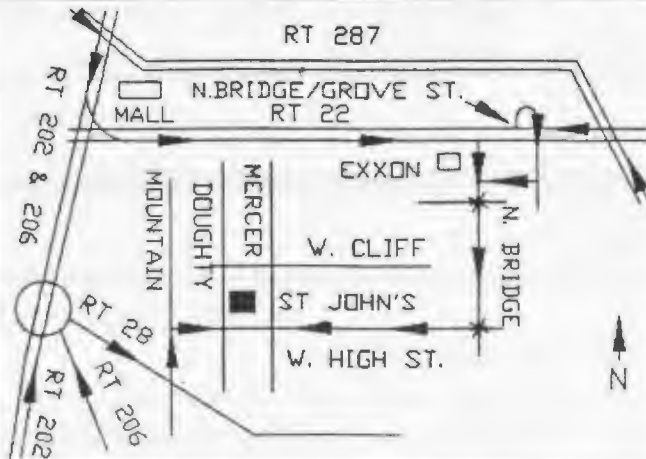
FOR MORE INFORMATION
IRMA & JOHN 908-722-3565
LINDA & MIKE 908-221-1579



LETTERS TO THE EDITORS

We would like to thank all of our friends in the square and round dance activity for their expression of concern after our Friday the 13th auto accident in October. All of you, and especially the Garden State Campers, played such an important role in our quick recovery.

The cards and calls were very heartwarming and we hope to be back in a square with you by early December. The bones are healing and the car and trailer can be replaced. But friends like all of you are one in a million. Thank you all.

Helen & Bill Ruckel

IRONIA REELERS – Randolph, NJ**PL****1 & 3 Fri. Sept-June****Ironia Elem. Sch., Dover-Chester Rd., Rt. 513**

What better season for square dancing than fall? We're happy to report that our Wednesday Mainstream class is off to a good start. On October 6, the Hunterdon Flutterwheels raided us and on October 27, nine Reeler couples raided the Circle Eights. We were delighted at our November 3 dance to have a surprise visit from former members John & Renee Kaiser, who now live in Collingswood, Illinois.

Once again the November Mini-Festival was a high point of the fall season for our members. We danced to a wonderful array of callers, chatted with friends from other clubs whom we haven't seen in a while, shopped for additions to our dancing wardrobes, and feasted on our collective pot-luck offerings.

Ad on page 59



Jean & Inars Gruntals

201-543-7792



RICHMOND DANCERS

2 & 4 Saturdays**Pre-Rounds at 8:00 p.m.****Plus Squares 8:30-11:00 p.m.**

<u>Date:</u>	<u>Caller:</u>		<u>Cuer:</u>	<u>Theme:</u>
Jan. 27	Dan Koff		Kathy Koff	
Feb. 10	Dan Koff		Kathy Koff	
Feb. 24	Manny Amor		Karen Kushla	
Mar. 9	Len Anfinen		Kathy Koff	
Mar. 23	Dick Pasvolsky		Karen Kushla	<i>Welcome Spring</i>
Apr. 13	Howard Richman		Kathy Koff	
Apr. 27	Dalt Young		Karen Kushla	<i>Golden Oldies</i>

All Saints Episcopal Church, 2329 Victory Blvd., Staten Island, NY

From NJ: Take Victory Blvd. Exit from the SI Expwy. Make left on Victory to Crystal Ave. Make left on Crystal. Church lot is the 2nd right.

From Brooklyn: Take the Bradley Ave. Exit from the SI Expwy. Make right onto Bradley. Make left at Victory Blvd. to Crystal Ave. Make right on Crystal. Church lot is 2nd right.

Info: Andersons: 718-727-5141; Reids: 718-727-5469;
Rubensteins: 718-442-4916

No Pre-RoundsSpecial drawing for a free admission for visitors who come across a bridge.***KINGS SQUARES -- Brooklyn, NY****PL****1 & 3 Sun. Sept-June****Redeemer St. John Ch., 939 83rd St.**

Hi, all you side and head couples! Time to center for a "celebration cup chain.." Kings started the "Grand Swing Thru" at their 21st Anniversary Dance on October 15, with Kings special caller, Frank Riviccio, and club members from "way back when."

We are looking forward to turkey trotting on November 19 with our pleasant Pilgrim pals, and Holiday dancing on December 17 with our jolly gent and ladies from Kings Squares.

Our New Year's dance on January 7 will find us promenading out the old and swinging in the New Year among the happy smiling gals and dudes singing and dancing to the strains of *Auld Lang Syne*. So bring us the presence of your company and drop by "Our Place." We'll trim the tree and light the lights because the *Gang's All Here*. All we need is Y-O-U. Have a happy and merry.

Ad on page 46

Terry Arcello

718-382-0036

Kittatinny Rangers

present their

FIFTH
ANNUAL

DINNER
DANCE

Squares By

Joe Fioretti, FL
Marvin Northrup,
NY



**HAWAIIAN
LUAU**

Rounds By

Al & Gale Spinks

Alternating Plus and Mainstream, with rounds

March 24, 1996
2:00 PM to 7:30 PM
\$21.00 per Person

"VASA PARK"
Budd Lake, NJ

For more information call Donna Poyer at 908-852-9285

"BEAUTIFUL - wood floor for dancing"



FOR TICKETS, CUT OFF AND MAIL - PLEASE RETURN BY MARCH 18th

NAME _____

STREET ADDRESS _____

CITY _____

STATE _____

ZIP _____

CLUB NAME _____

TELEPHONE NUMBER _____

NUMBER OF TICKETS _____ @ \$21.00/PERSON = TOTAL ENCLOSED \$ _____

MAKE CHECK PAYABLE TO "KITTATINNY RANGERS SQUARE DANCE CLUB"

MAIL TO:

Sue Bridenbaugh
39 Van Horn Road
Newton, NJ 07860
201-383-7060

GS

PLEASE ENCLOSE A SELF-ADDRESSED, STAMPED ENVELOPE. THANK YOU.

HUNTERDON FLUTTERWHEELS

Echo Hill Park, Lilac Drive, Stanton, NJ

1st & 3rd Fridays 8:00-10:30 PM Early Rounds 7:30 PM

Wilson Hoff - Caller

Peg Dockery - Cuer

Alternate MS & Plus Tips

Soft sole Shoes - Please

For More Information

Stan & Sandy 908-995-7369

Pat & Don

908-782-0696

- Jan. 5 Regular Dance
 Jan. 19 Regular Dance
 Feb. 2 Regular Dance
 Feb. 16 Valentines Dance -
 - Pie Night
 Mar. 1 Covered Dish Dance
 Mar. 15 St. Patricks Dance
 Mar 29 Regular Dance
 Apr. 5 NO Dance -
 - Good Friday
 Apr. 19 Regular Dance

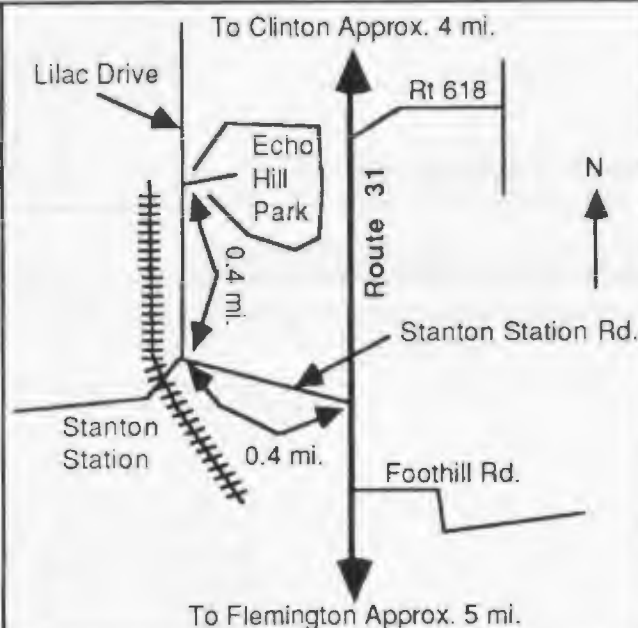

KITTATINNY RANGERS -- Andover, NJ

MS/PL tip

2 & 4 Fri. Sept-June

Long Pond School, Lime Crest Road

May all of us wish all of you a very Happy New Year, health to dance the year through with a happy partner at your side.

Our Open House netted six new members. Talk about youth--one is 6 years old and one is 11 years old. They're doing just fine, thank you, and getting all those wiggles in too. They brighten our evening I'll tell you.

Mickey McFarland is teaching us Plus. She is so gifted. Even those Plus dancers who have opted to retake lessons are saying, "Yes, now I'm doing it right!"

We seem to have at least 2 squares at every function lately. There was a Barn Dance, a raid to Country Promenaders, the terrific UN demo. Talk about success! People from all over the world mobbed our dancers to learn how it was done. "Bowling with Leslie" was a big social with friends from other clubs joining in. The Thanksgiving Dance netted a huge basket of food for the needy. On "One Square is Fair," we had so many people at the Mini-Festival. All of them breathless from that hoot of a Texas caller. It was GREAT! Speaking of great, Chuck Connor and Sally Mason are well enough to be dancing with us again. Yellow Rock your partner, people.

Ad on page 36

John & Ruth Seaman

201-764-7134

DID IT REALLY HAPPEN?

A little birdie told us that at a club's "Pie Night," someone actually threw a banana cream pie at the club caller.

The caller said, "It fulfilled a lifelong fantasy!"

Different pies for different folks. We prefer chocolate cream!

LAKELAND SQUARES – Parsippany, NJ **MS/PL tip**
Every Tues. Sept-July **Temple Beth Am, 879 S. Beverwyck Rd.**

It's been a busy and fun fall for Lakelanders and their guests. Pal Johnson is doing a fantastic job as teacher of 8 students. They are doing very well and we look forward to having them become active members of Lakeland Squares when they finish their classes.

Our Halloween Dance was very successful, with an assortment of witches and devils. We also had Cleopatra, Juan Valdez, a very voluptuous old lady, Hershey Bars, the Amazing Dancing Bears, cave man and woman, a couple from the Roaring 20s, and a costume depicting the square dance call "Recycle." Prizes were awarded and those who chose not to wear costumes were "penalized" by having to dance *The Chicken Dance*. Of course, we also enjoyed the donuts and cider provided by the members. Our veterans were honored with a very moving ceremony at the Veteran's Day Dance. Those who could wore their uniforms (or at least their hats). We enjoyed a variety of pies at Pie Night. Those Lakelanders are some bakers! We saved some to be auctioned off so that the culinary enjoyment could continue at home.

I think we have one for the Guinness Book of Records: Catherine & Jim Douglas, who graduated in April '95, completed their Century Book in October '95. They danced in 6 different states and attended lots of conventions.

Undaunted by heavy rain, 17 of us raided Richmond Dancers, where we were warmly welcomed and shared in a wonderful dance. We've got lots of interesting themes coming up and hope all of you will share them with us.

Ad on page 45

Margaret Brownell

201-584-5969

BUILD CONFIDENCE • SHARPEN SKILLS • REINFORCE LESSONS

BASIC, MAINSTREAM and PLUS

SECOND HALF **PROGRAM VIDEOS**



Outside U.S. add \$10. Specify "Payable in U.S. Dollars"
Check or MO only.

© 1987-1990 Tra Bien, Inc

Broadcast quality video tapes. Filmed in television studio, featuring overhead shots.

<p>BASIC SECOND HALF (movements 26-50)</p> <p>\$49⁹⁵</p>	<p>MAINSTREAM (Callerlab sequence 51-67)</p> <p>\$39⁹⁵</p>	<p>PLUS (27 movements)</p> <p>\$49⁹⁵</p>
---	---	---

Featuring BETSY GOTTA Caller. 30+ years. Member Board of Governors. Callerlab.



Callerlab approved!

Add \$3.50 postage and handling • N.J. res. add 6% sales tax

Please specify BASIC MAINSTREAM PLUS VHS BETA

Mail check or money order to:

SQUARE DANCE VIDEOS

A Division of Tra Bien, Inc.
P.O. Box 1350, Maplewood, NJ 07040



Name (Please Print) _____

Address _____

City _____

State _____ Zip _____

GS

A study of economics usually reveals that the best time to buy anything is last year.

Marty Allen

HELP WANTED HELP WANTED HELP WANTED

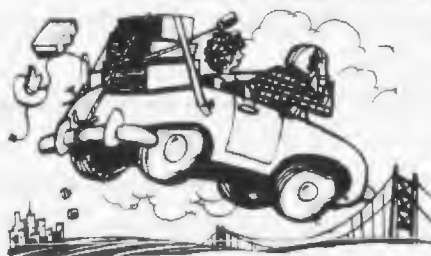

If you are driving to the NSDC in San Antonio, TX this year, please consider carrying the NNJSDA Display or boxes of **Grand Square**. Contact Gus & Marilyn Bachmann 3rd VPs at 201-261-3921 or the Editors at 718-448-9761.

LEISURE SQUARES – E. Stroudsburg, PA Alt. MS/PL

1 & 3 Sat. Oct-Dec & Mar-May J.M. Hill School, East Broad St.

Our season began with our Aloha Dance. To put everyone in the mood, leis were given out and the dancers wore colorful casual clothes. Paper grass skirts provided by Viv & Chuck Hatfield could be seen swaying in the breeze. Island music such as Pearly Shells sung by Dalt Young really added to the Hawaiian atmosphere. Before we knew it, it was 10 p.m. and time to say "Aloha" until the next dance.

The Octoberfest drew a nice crowd. With beer steins and scarecrows on the table, there was no doubt which dance this was. An opportunity was provided at the Crazy Hat Dance for unusual chapeaux to be worn. There was a jester, sorceress, flowered bonnets, and newspaper hats. The winners, Linda & Bob Kozarek, wore an upside-down colander with sunflowers poking through the holes and a monkey hat. More than 20 members from Cross Trail Squares raided us and it was nice to see so many familiar faces. Hope to see many more at our next dance.

Leisure Squares is on hiatus during January and February. We will resume dancing on March 2.

Ad on page 63

Millie Connelly

717-588-9226

The Rutgers Promenaders

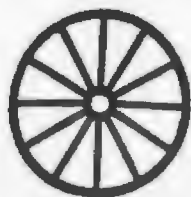

Present our 4th annual

Chinese Auction

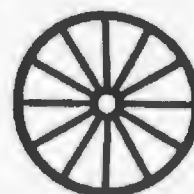

&

Presidents Dance

Date: February 22, 1996
Time: 8 PM to 10:30 PM
Place: American Legion Post 459
1015 Linwood Place, North Brunswick NJ
Squares: Betsy Gotta
Rounds: Roy Gotta
Cost: \$4/person

Come join us for our annual fund raiser dance. Featuring an enjoyable night of dancing, and chances to win many exciting prizes. Chinese auction tickets available at the dance for anyone who wishes to play.

Wander through winter with... Belles & Beaux

square dance club

M (+tips)

Coleman School, 100 Pinelynn Rd., Glen Rock

(Take Route 4 to Route 208. Maple Ave. exit; Turn right onto Harristown Road. Pinelynn is the 1st right turn off Harristown Rd. north of the Glen Rock Jewish Center. Call for other directions!!)

8-10pm

- Feb. 7 Dick Mazziotti's calling for our Valentine's Dance! Who will be your mystery valentine??
- Feb. 21 Canceled — no place to dance!
- March 6 Dot Loewenstein & Nick Martellacci *Double* the dancing fun!
- March 20 Dick Mazziotti—St. Patrick's Dance with our Italian leprechaun
- April 3 Jim Snyder—Welcome spring!
- April 17 Dick Mazziotti—Class of 1996 graduation

soft-soled shoes--PLEASE!

Questions? call Margaret (201) 384-2791 or Rich & Rusty (201) 838-0312

MOTIV8ORS -- Paramus, NJ

A-2 /C-1 tip

1, 3 & some 5 Sun. Sept-June

Jewish Community Center

Every Sun. Jul & Aug

Midland Ave. at Spring Valley Rd.

Alt. Site: 1st Presby. Ch, Maplewood & Sherwood, Clifton

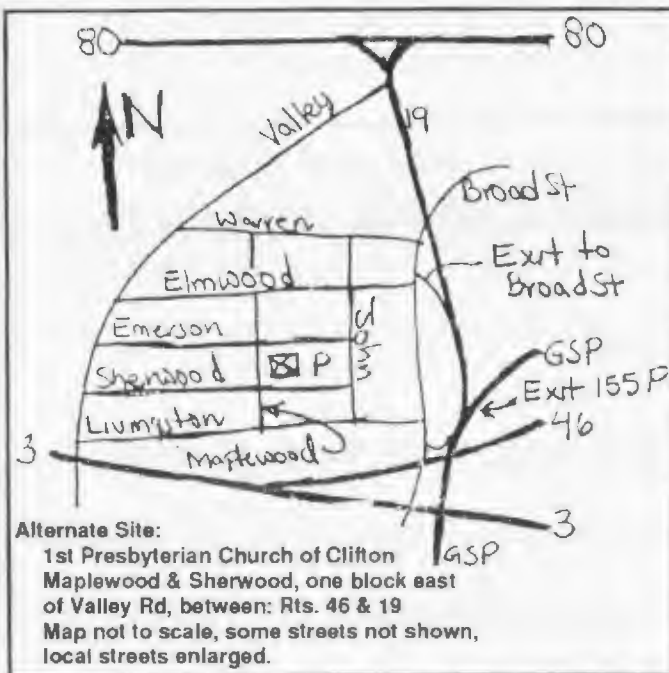

Beginning in March, a few of our dances will be held at an alternate location, the First Presbyterian Church of Clifton, located at the corner of Maplewood and Sherwood, one block east of Valley Road, between Rts. 46 & 19. Please consult our flyers and ad in this issue for specific dates. The map to the left depicts the alternate location. If there are any questions, please call Conrad & Janet at 201-470-8563.

Our Advanced class taught by Roy Leber is progressing at a good pace. The students are very enthusiastic, and it won't be long before we welcome them into our squares.

Our ever-popular Nick & Carole Raspa cue the rounds for our dancers. Last fall the list of callers included Roy Leber, Mark Franks, Ed Foote, Randy Page, Todd Fellegly, and Lee Kopman, and our spring calendar boasts a roster of equally top-notch callers. All A-2 dancers are welcome. We promise a fun-filled evening!

Ad on page 34

Bob & Liz Sly

201-391-0248

MOUNTAIN SQUARES -- Whippany, NJ

A-2

1 & 3 Wed. Sept-June

First Presbyterian Ch., 494 Route 10

The autumn dancing at Mountain Squares has been excellent. We have had good calling by our club caller, Joe Landi; good attendance, thanks to our club members and friends who fill our hall; food, thanks to our good cooks; and good fun! Speaking of visitors, we have had several who have some quite a distance to dance with us. Jack & Martha Jaremba, former members of Mountain Squares, were in the area from Daytona Beach, FL, and stopped by in the early fall. Wes & Helen Woodman from Silver Springs, NC, were here the same evening. The Woodmans have a goal of dancing in every state in the USA. They travel by RV, covering small sections of the country at a time. What a wonderful way to tour the country! Dick & Shirley White also visited from their new home in New Hampshire. We enjoy all visitors and all A-2 dancers are most welcome.

Mountain Squares hosted a dance for John Kaltenthaler's Advanced class in November; Joe Landi called, and a great time was had by all. We are looking forward to having dancers from both John Kaltenthaler's and Roy Leber's classes join us when they have completed their lessons.

Our sympathy is extended to Bill Groth and his family upon the death of Bill's mother in late October. The loss of a parent is always a great sadness.

Ad on page 71

Bob & Liz Sly

201-391-0248

COUNTRY PROMENADERS



Stelton Community Center
Plainfield Ave., Edison, NJ
Two blocks from Route 27
10 min from Tpk, GSP, 287



Hall Phone (908) 287-5678
Jan & Louis (908) 577-9413
Pat (908) 819-7483
Inclement weather: call first

JOIN US FOR FUN DANCING & GREAT REFRESHMENTS

2nd & 4th SATURDAYS - NO BOOTS or HIGH-HEELED SHOES
Early Rounds: Steve Bradt 7:30 - Plus Level Squares 8:00 - 10:30

January 27 HOWARD RICHMAN

★ February 10 BRIAN FUGERE - Sweets for the Sweet / Pie Nite!

February 24 ★ ★ ★ ★ **GARNIVALE** ★ ★ ★ ★

TIM MARRINER (Natl. Caller - GA) Costume Dance!

March 9 JIM SNYDER

March 23 JOHN KALTENTHALER

April 13 MARK FRANKS

NEW ATTRACTION: ADVANCED OR DBD PLUS TIP AT END OF DANCE!

★ **Location Change:** 1st Presb. Church of Cranford / **Guest cuer:** Al Spinks

PRINCETON SQUARES

Princeton Squares has suspended dancing as of January 1996. According to the NNJSDA Constitution and ByLaws Section 11e: *The day, time, and location of the disbanded club will be protected for a period of six months after the date of disbandment, at which time application for the area of responsibility of the disbanded club can be made in writing to the NNJSDA Recording Secretaries in accordance with NNJSDA ByLaws.*

A Couples Only Resort For All Seasons
BIRCHWOOD in the EXCLUSIVES

5th Annual

Getaway Weekend

PLUS

MAY 3-5, 1996

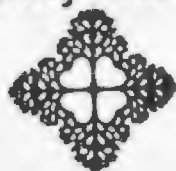

**DOT LOEWENSTEIN
NICK MARTELLACCI**

WOOD DANCE FLOOR!

Archery Bicycles Bocce Indoor Pool

WOOD DANCE FLOOR!

Pedal Boats Putting Green Skeet Tennis

**\$318 (Jamestown) (Manor House)
no Jacuzzi**

**\$358 (WILLIAMSBURG)
excluding "Deluxe"**

\$378 (Plymouth) (Colonial) (Deluxe)

>Mail with \$100 deposit to:

**DOT LOEWENSTEIN<
77 Lincoln Ave, Elmwood Park, NJ
07407**

QUESTIONS ? (201) 797 1934

Note: Price (per couple) includes
all taxes & tips, 5 Gourmet meals
(all you can eat), fridge, private A/C
unit with color TV, Queen size bed.

**All chalets assigned on a
first-deposit basis.**

NAME _____

STREET _____

CITY, STATE: _____

PHONE: (____) _____

CLUB: _____

GS

**RICHMOND DANCERS --Staten Island, NY PL
2 & 4 Sat. Sept-June All Saints Church, 2329 Victory Blvd.**

It was good to see you all at our Veteran's Day Dance. Everything and everyone was in red, white, and blue. The honor to all veterans was planned by the Branigans and raided by our fellow Islander club, Staten Square Set.

The Mini-Festival was a fun day with great dancing, calling, and eating. Richmond Dancers were in attendance with almost three squares.

We'd like to send our get well wishes to Donna Anderson and Anna Santangelo. We all hope you'll both be back on your feet again soon. Our congratulations to Richmond Dancers latest octogenarian, Bill Lettieri.

We end on a sad note: our RIOS class has folded for the year. It's up to each of us to find new dancers to join our next class. Think of the good times and friends not to mention all the goodies we share. Isn't it worth the commitment we make in learning to square dance? Be enthusiastic and share the news with prospective members. It will be a happy experience for all of us.

Hope you had a happy holiday season.

Ad on page 20

Grace & Lou Motola

718-447-1531

USA WEST SQUARE DANCE CONVENTION

August 6-9, 1997

Colorado Convention Center

Denver, Colorado

PO Box 440688

Aurora, CO 80044-0688

**Gold Nugget Pass at \$22 per person is available
thru February 10, 1996. Fax: 303-745-8596**



20th Anniversary
Myrtle Beach
 **Balls**

**CONVENTION CENTER
MYRTLE BEACH, SOUTH CAROLINA**

**APRIL 18, 19 & 20, 1996
and
SEPTEMBER 11, 12, 13 & 14, 1996**

April

**TONY OXENDINE, JERRY STORY,
& DARRYL McMILLAN
and
JACK & GENIE WHETSELL**

**SQUARES: MAINSTREAM, PLUS, PLUS DBD, ADVANCE, & C-1
ROUNDS: ALL PHASES
LINE DANCING & TEXAS TWO-STEP
After Party: *The Marriage of Frankie Hi-Stepper & Garwood Tuesday***

September

**TONY OXENDINE, JERRY STORY, BRONC WISE,
BILL HARRISON & JERRY BIGGERSTAFF
and
JERRY & BARBARA PIERCE
CURT & TAMMY WORLOCK**

**SQUARES: MAINSTREAM, PLUS, PLUS DBD, ADVANCE, & C-1
ROUNDS: ALL PHASES
LINE DANCING & TEXAS TWO-STEP
After Party: *"Miss Myrtle Beach" Bathing Beauty Contest***



Also - CALLERS' "RAP" SESSION, CALLERAMA,
FASHION SHOW (Sept.), and SEWING CLINIC (Sept.)

FOR TICKETS & INFORMATION, CONTACT:
BARBARA HARRELSON
1604 Grays Inn Road, Columbia, SC 29210
Tel. 1-803-731-4885
Fax 1-803-750-7222

ROCKYTOPS of ROCKLAND -- Pearl River, NY **PL/A-1 tip**
1st Fri. Oct-June **Pearl River United Meth. Ch., John St. at Franklin**

We hope you all had a great autumn filled with lots of square dancing, in spite of all the wind and rain. Thanks to varied and challenging calling by national callers and the cueing by Nick & Carol Raspa, we had an excellent turnout for our Autumn dances (averaging 12 squares). At our recent raid of Hi Taw Twirlers, there were approximately 50 RockyToppers. That's quite a showing.

A warm welcome to our newest members: Glenn Miller, Harriet & Irwin Ballin, Steven & Elaine Cohen, Doug & Pat Nuetsman, Richard & Iris Eschrich, and John & Phyllis McGrory.

Congratulations to Gloria & Leon on their 50th Wedding Anniversary. We all wish you many more years of wedded bliss. Congratulations to the Landons. They were chosen as RockyTops couple of the year for the Hudson Valley Council dance. Welcome back to Lyn & Bob Terry on their return from a trip to China. Congratulations to Art & Sandy Sadow on the marriage of their son.

We welcome all of you Plus and round dancers to the warm and friendly RockyTops world, from the welcome greeting to the final round and Plus tips through the A-1 tip and friendly goodnight. Good dancing, good friends, and good food make for great time. Our Pear River location is 20 minutes from the intersection of the GSP and Rt. 80 in Saddle Brook and 10 minutes from Exit 172 of the GSP.

Ad on page 11

Maria & Roger Hoernlein

201-384-0334



You're invited to join us for. . .



Belles & Beaux'

Hearts & Flowers



mystery bus raid

Saturday, May 11, 1996

Where will we eat???

Where will we dance???

bus will leave promptly at 2:30pm from Glen Rock High School parking lot.

\$35 per person

(for more details & registration form, see our flyers!)



There is very little difference in people, but that little difference makes a big difference. The little difference is attitude. The big difference is whether it is positive or negative.

Clement Stone

RUTGERS PROMENADERS – North Brunswick, NJ MS
2 & 4 Thurs. Sept-May American Legion, 1015 Linwood Pl.

What a year 1995 was! We started out the dancing year with a new little member, Julie Anne Koft, who arrived just before announcement time at the October 12th club dance. Betsy Gotta followed up the good news with an appropriate singing call, *I've Got a New Baby!* Congratulations to parents Dan & Kathy Koft and grandparents Bernie & Betty Koft!

I am sorry to announce that Rutgers' lessons have folded due to a lack of students. We hope to try again next year, with better results. Our club is still going, however, and working on our raid program (thanks to Raid Chairmen, Ken & Helena Robinson). On November 17th, we raided Ironia Reelers, and enjoyed the dancing and the friendly people we met. Also, December 10th was our 20th annual Toys for Kids dance, where generous dancers donated many toys for children with AIDS in area hospitals.

Some of you may remember Bill & Patrice Hartung, who used to dance with Rutgers Promenaders. They have just welcomed their fourth child, born in early December, named Virginia Marie (great name--it's also this reporter's!).

At this writing, the year is quickly coming to a close, bringing the holidays, a theme dance on December 28th--"Pizza on Earth" (wonder what the callers have in store for us???), and the Five Clubs New Year's Eve Dance. As you read this, they are all but happy memories, and we look forward to 1996 and all the good time ahead. See you on the dance floor.

Ad on page 53

Ginny Platania

908-249-0916



**35TH INTERNATIONAL
SQUARE & ROUND DANCE CONVENTION
MAY 10, 11, 1996**

McMaster University, Hamilton, Ontario, Canada

SQUARES - MAINSTREAM TO C2 ROUNDS - PHASES II TO VI

ENJOY THIS GREAT STAFF

**LES GREENWOOD
JIM LEE
JOHN MARSHALL**

**TIM MARRINER
ART SPRINGER
JOE UEBELACKER**

ROD & SUSAN ANDERSON

**ASSISTED BY AREA CALLERS/LEADERS
PLUS WORKSHOPS AND DISCUSSIONS**

REGISTRATION (per person) CAN. \$25.00 U.S. \$20.00

Complete package: Dancing, accommodation & meal package at McMaster University Campus -
2 nights & 5 meals (per person) CAN. \$144.00 U.S. \$113.00

CAMPUS TRAIL-IN DANCE THURS., MAY 9, 8-11 P.M. PLUS, RDS (II - IV)
AND C1. \$7.00 P.P. PAYABLE AT THE DOOR ONLY.

McMASTER BED AND BREAKFAST FOR MAY 9, \$40.00 P.P. IN ADDITION
TO COMPLETE PACKAGE.

For Information & Brochures, write to: Louise Johnson 51 Glynn Rd., Ajax, Ontario. L1S 2C5

The pursuit of the truth shall set you free - even
if you never catch up with it.

VALLEY SQUARES

1 st & 3 rd Thursdays
8:00 to 10:30
PLUS Program
Soft Soled Shoes Please

Watchung Hills Regional H.S.; Stirling Rd, Warren, NJ

Round Dance Workshop
7:30 to 8:00

Carl Hanks

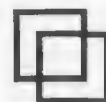

Have a MERRY HOLIDAY SEASON & HAPPY NEW YEAR
(Dancing in Student Lounge - some exceptions)

DATE	CALLER	CUER	THEME
Dec 7	Carl Hanks	Nick Raspa	
Dec 21	Carl Hanks	Peg Tristram	COOKIE TIME
Jan 4	Dan Koft	Kathy Koft	
Jan 18	Joe Landi	Karen Kushla	
Feb 1	Len Anfinson	Nick Raspa	"KIDS AT HEART"
Feb 15	John Kaltenthaler	Peg Tristram	
Mar 7	Carl Hanks	Kathy Koft	"ROOTS"
Mar 21	Carl Hanks	Karen Kushla	

Information: Carol & Duke (201) 528-8996 ; Barry & Norma (908) 464-1730

SEE SAW SQUARES -- Upper Saddle River, NJ MS/PL/CW
PL - 3 Sat. Sept-June Old Stone Ch. Ed. Ctr, 500 East Saddle River Rd.

After successful raids to Belles & Beaux and Spinning Wheels during the summer, we of See Saw Squares added Rockland Promenaders, Circle Eights, and Tenafly Squares to our list of raided clubs. The folks at Tenafly Squares were especially hospitable, allowing our raiders to win three of the evening's 50-50 prizes.

We collected nonperishable food items for a local pantry at our November dance with Randy Page. Thanks to all for the many generous donations.

Phoebe & Jack Linden spent a week square dancing at English Mountain Resort in Tennessee during the summer, and Co-Presidents Hillela & Bob Ward went to the New York State Convention in Buffalo. Among our recent foreign travelers are VPs Allene & Gerry Turer, who went to Turkey, and Lyn & Bob Terry, who went to China. Our Raid Chairperson Carolyn Monohan is sailing on a 33-foot sloop in the Caribbean.

See Saw Squares welcomes visitors, both couples and singles. We hope to see you on the dance floor soon.

Ad on page 60

Lyn & Bob Terry

201-327-9274

COMING IN THE NEXT ISSUE -

To help you book callers and cuers
for upcoming dances, a list of:
Caller's Council of New Jersey (CCNJ) Members
and
Northern New Jersey Round Dance Leaders
Council (NNJRDLC) Members

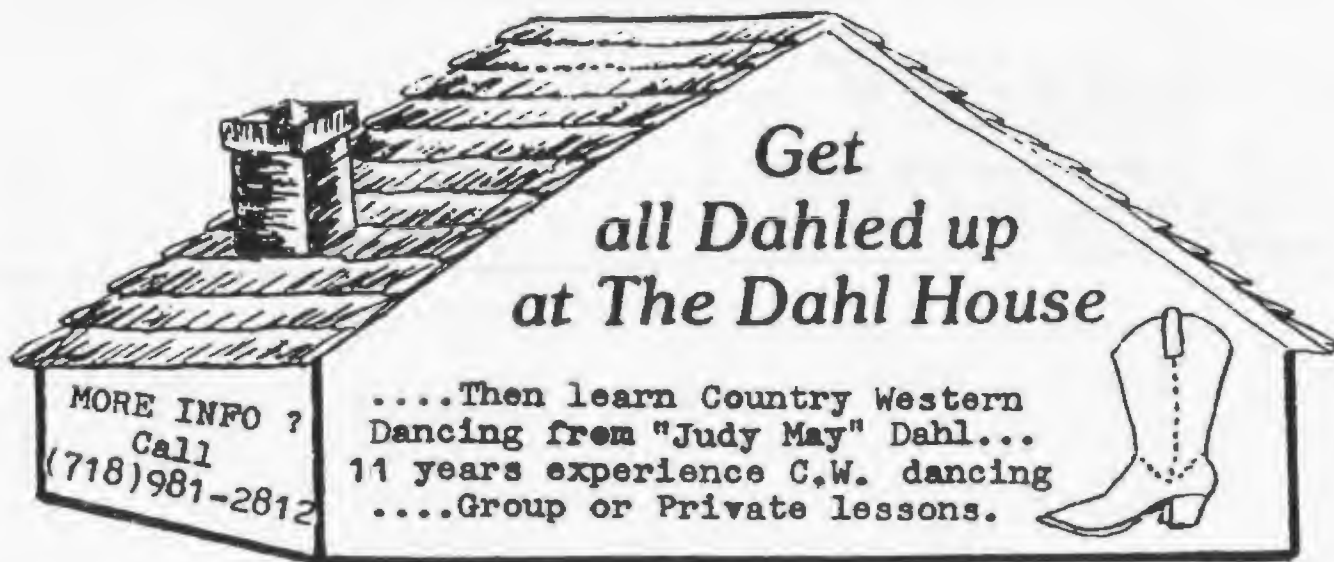

SPINNING WHEELS of WAYNE -- Wayne, NJ MS/PL tip/CW
Every Mon. Sept-June **Wayne Civic Center,**
2 & 4 Mon. July & Aug **Hamburg Turnpike & Church Lane**

We are off to a great start with 17 new students on Wednesday nights at the Oakland Community School. They're doing so well that we are starting another Beginner's Class on Tuesday nights in Oakland at Valley Middle School from February 27 through June. Bob Robinson is teaching squares and I am teaching Country Western dances and teaching the squares when Bob is away on business. Call me if you know of anyone who would like to take lessons now. Our club members have been excellent angels and we're having a wonderful time.

Our club dances have been well attended and our callers have been doing some very interesting choreography helping us to have our usual enjoyable evenings. Spinning Wheels is the place to be on Monday nights, except for February 12 and 19, which are holidays and the Civic Center is closed. Come join us on any other Monday.

Ad on page 38

Dolores Gesumaria

201-337-8365

BUCKS-TRENTON DISTRICT

Sunday Special

Sunday, February 4, 1996

Nottingham Ballroom

Mercer Street
Hamilton Square, NJ

WATCH FOR FLIERS!

MIKE CALLAHAN

Rochester, NY

Squares

Plus 2x2 2:00-4:30

A-2 Tip: 4:30

RON RUMBLE

Rounds

Pre-rounds 1:30

Lechner 609-924-7545
Lindbloom 609-882-3949

Dear Readers:

As we see our sixth year as Editors already half over, we wonder how much longer we will be able to continue. Believe it or not, our most difficult problem is obtaining the information from **you** that it is to be printed.

Every issue we have to contend with reporters and ad makers who do not follow through with their job to send us their material. Then, we have to contend with those who do their job, to a degree. They fire off an article or an ad, and it's wrong. They write about a dance that hasn't happened yet, and then it's cancelled; or the ad arrives with the wrong dates (3-4 each issue). But by far the

Please turn to page 39

STATEN SQUARE SET – Staten Island, NY

PL

1 & 3 Sat. Oct-June

St. Alban's Ch, 76 St. Alban's Pl.

We missed our dances in November because the church was having a holiday fair on the 1st Saturday, and then another scheduling conflict with our 3rd Saturday dance. So we ended up with no dances in November. We apologize for any inconvenience it may have caused. We celebrated our 47th Anniversary dance in October and a good time dancing to Glenn Matthew and Lois Bichler was had by all who attended.

This year we have Presidents who love to travel and we almost lost them in Mexico. Seems there was a little mix-up in the airplane or something. Ask Ed & Evelyn and they will give you the scoop. We are happy they returned to us safe and sound.

Get well wishes got out to Tom Javaruski and to Frank Riviccio. We hope to see you both out dancing (not together) real soon.

As I am preparing this article, the holidays are fast approaching and we will be starting a New Year. We want to take this opportunity to express our desire that you each have a year filled with good health and have a lot of FUN square dancing. Have a happy.....

Ad on page 50

Chris & Pete Peterson

718-984-1623

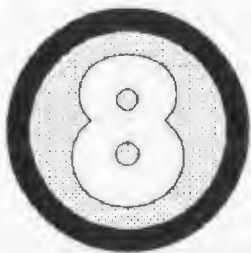

CIRCLE EIGHTS

MAINSTREAM DANCING

1996 Schedule:

Jan. 26 - Andy Woerner
 Feb. 23 - Mickey McFarland
 Mar. 22 - Don Coy

April 26 - Andy Woerner

Student Dance
 Suspenders Nite
 Pre-Tax Bash
 Wear Red or Black
 Graduation
 All Welcome

*Come with a partner or alone -
at Circle Eights Everyone dances*

8 - 10:30 on 4th Fridays

St. Luke's Church

cor Massachusetts & Grant, Haworth



Info (201) 525-1925 or (201) 387-1135

NJ SQUARE DANCE LICENSE PLATES

For information about obtaining a NJ square dance license plate, contact Richard Delgado, SDCNJ Plate Liaison to Motor Vehicle Services, 28 Bayberry Road, Trenton, NJ 08618, 609-530-0849. The cost is still a bargain at \$30.00. What a great way to advertise square dancing and recruit new dancers.

TENAFLY SQUARES – Haworth, NJ**MS****2nd Fri. Sept-Jun****St. Luke's Episcopal Ch, Mass. & Grant Aves.**

At our October Autumn Leaves Dance, Don Coy gave us an intensive workshop on "Pass In." (Some dancers wanted to "pass out," but a good time was had by all.) Salute Our Veterans was the theme of our patriotic November Dance with the inimitable Howard Richman putting us through our paces. Due to a broken lock on the door, we almost didn't get into the hall! We thank our friends of See Saw Squares for raiding us at that dance. Nick Raspa cued the rounds at both dances.

With the holidays fast approaching, we wish all our friends a Happy New Year and look forward to seeing them at our 1996 dances.

Ad on page 15

Frank Poole

201-342-3375

moti v 8 o r s

A-2 Level Dancing - Sundays 7:30 to 10:00 pm
Jewish Community Center of Paramus
Midland Ave & Spring Valley Rd - Paramus, NJ

Nick & Carole Raspa on Rounds starting at 7:00 pm
Hall Phone: (201)262-9860

Alternate Location: 1st Presbyterian Church of Clifton
corner of Maplewood & Sherwood, Clifton, NJ
(see map on page 25)

* * * 1996 * * *

Jan. 21	Randy Page *	Mar. 3	Todd Fellegy *	Alternate Location
Feb. 4	Mike Jacobs	Mar. 17	Roy Leber	
Feb. 18	No Dance	Mar. 31	George Jedicka	
Feb. 25	Don Crosby	Apr. 7	No Dance	

*C-1 Aftertip with these callers only

Conrad & Janet: 201-470-8563
Beth: 718-601-1902

Sid & Marianne: 908-757-8374
George & Fanny: 201-385-3263

Hall Phone: 201-262-9860

TENAKILL TWIRLERS -- Cresskill, NJ**MS/PL tips****3rd Fri. Oct-May****Bryan School, Brookside Ave.**

It was misty night, but the weather didn't dampen the spirits of the small group of dancers who turned up for the first dance of season in October. Dick Mazziotti gave us a good dance with his challenging Mainstream calls. Unfortunately, our November 17th dance had to be canceled because of a conflict with the school.

We hope that more dancers will find their way to our dances and enjoy our various callers. Happy New Year to all!

Ad on page 10

Frank Poole

201-342-3375

38TH NEW ENGLAND SQUARE & ROUND DANCE CONVENTION**April 26 & 27 1996 - Bangor, Maine**

Registration forms available from: Peter & Phyllis Viets,
PO Box 334, Unity, ME 04988-0334; 800-247-2668.



M & M SQUARES

Pascack Reformed Church Hall, Pascack Road, Park Ridge,
New Jersey. Just minutes from GS Pkwy. See map.



Dancing at the BASIC Program



Join us at the ONLY Basic program club in the Northeast!!! We will dance the first 50 calls on the list, by definition and all position!!! Our first few dances will be at whatever level of calls the students are. ALL STUDENTS WELCOME!!! Dancers who join the club this year will be Charter Members!! Join us at our FIRST CLUB DANCE December 2. Bring your new dancers along. ALL NEW DANCERS WELCOME. NOTE: Square dance attire OPTIONAL! Soft soled shoes only please. We are going to concentrate on having FUN!

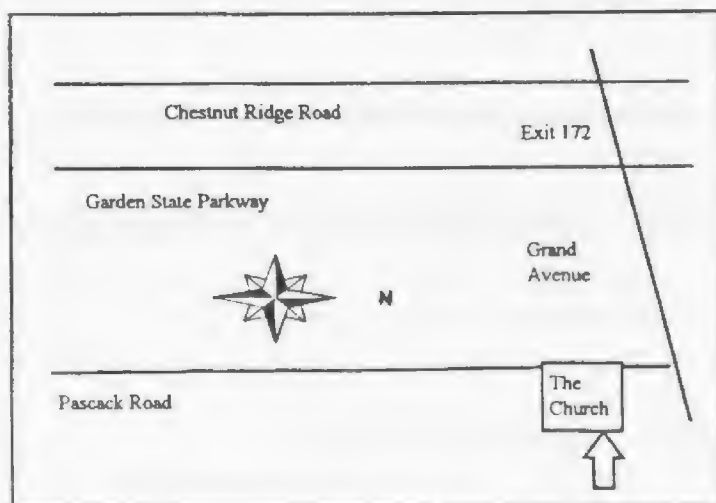

Call Dick & Laurie Mazziotti
for more info or to plan a raid
(201)664-4482)

1995-96 DANCE SCHED.

First Saturdays, 7:30 - 10:00

- December 2
- January 6
- February 3
- March 2
- April (no dance)
- May 4
- June 1

We'll dance over the
summer if there is interest in
doing so.

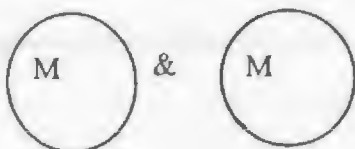

Student Dance Calendar

Following is a list of dances especially for the student dancer.

Please see the club ad in this issue for details and call to confirm before travelling.

*All times are P.M. except as noted.

Date/Time*	Club/Contact	Location	Callers
January:			
26 8:00	Circle Eights 201-525-1925 201-387-1135	St. Luke's church cor. Mass. & Grant Haworth, NJ	Woerner Ad on page 33
28 2:00	NNJSDA Mid-Term Ball 201-838-0312 Berg 201-697-5208	Lincoln Park Comm Ctr. Rt. 202 & Chapel Hill Rd. Lincoln Park, NJ	Mazziotti Ad on page 3
30 7:30	Lakeland Squares Carol 201-334-1196 Kathy 201-366-8064	Temple Beth Am 879 S. Beverwyck Rd. Parsippany, NJ	Wadel Ad on page 45
February:			
3 7:30	M & M Squares Mazziotti 201-664-4482	Pascack Reformed Ch. Pascack Rd. Park Ridge, NJ	Mazziotti Ad on page 35
10 8:00	Sat. Nite Live Woerner 201-261-1047	Ch. Good Shepherd Prospect St & New Bridge Bergenfield, NJ	Woerner Ad on page 37
11 7:30	Al'e'Mo Squares Vincent 718-615-1507 Caroline 718-745-3793	Ft. Hamilton Comm. Ctr. Ft. Hamilton Army Base Brooklyn, NY	Hardy Ad on page 16
11 2:00	Belles & Beaux Margaret 201-384-2791 Rich 201-838-0312	Glen Rock Comm. Ch. cor. Rock Rd & Hamilton Glen Rock, NJ	Mazziotti Johnson Ad on page 8
20 7:30	Lakeland Squares Carol 201-334-1196 Kathy 201-366-8064	Temple Beth Am 879 S. Beverwyck Rd. Parsippany, NJ	Mitchell Ad on page 45
25 2:00	Callers Council of NJ Richman 201-433-9673	Glen Rock Comm. Ch. 354 Rock Rd. Geln Rock, NJ	Many callers Ad on page 9
March:			
2 7:30	M & M Squares Mazziotti 201-664-4482	Pascack Reformed Ch. Pascack Rd. Park Ridge, NJ	Mazziotti Ad on page 35
8 8:00	Kittatinny Rangers Lawrence 201-726-9463 Jaworski 201-729-1203	Long Pond School Limecrest Road Andover, NJ	McFarland Ad on page 36

* * * * *

KITTATINNY RANGERS

2 & 4 Fridays
MS with Plus Tip

Long Pond School
Andover, NJ

JAN 26	(7:30 PM)	LEN ANFINSEN
FEB 9	(7:30 PM)	MICKEY McFARLAND / ROUNDS - AL SPINKS
●FEB 23	(8:00 PM)	FRED WEINER
MAR 8	(7:30 PM)	MICKEY McFARLAND (STUDENT DANCE)
●MAR 22	(8:00 PM)	RICH MURPHY

* * * * *

●LOCATION TBA - INFO: DONNA POYER - 908-852-9285

* * * * *

Saturday Nite Live!

three class level dances with Andy Woerner

- ★ Saturday January 13
- ★ Saturday February 10
- ★ Saturday March 9

at the
Church of the Good Shepherd
Prospect St & New Bridge Rd.
Bergenfield NJ



8:00 PM with bells on
for more information call (201) 261-1047

March contd.

8	8:00	Tenafly Squares John & Betty 201-666-8937 John & Madeline 201-384-5407	St. Luke's Church cor. Mass. & Grant Haworth, NJ	Coy Ad on page 15
9	8:00	Sat. Nite Live Woerner 201-261-1047	Ch. Good Shepherd Prospect St & New Bridge Bergenfield, NJ	Woerner Ad on page 37
10	2:00	Belles & Beaux Margaret 201-384-2791 Rich 201-838-0312	Glen Rock Comm. Ch. cor. Rock Rd & Hamilton Glen Rock, NJ	Mazziotti Johnson Ad on page 8
19	7:30	Lakeland Squares Carol 201-334-1196 Kathy 201-366-8064	Temple Beth Am 879 S. Beverwyck Rd. Parsippany, NJ	Mitchell Ad on page 45

April

14	2:00	Belles & Beaux Margaret 201-384-2791 Rich 201-838-0312	Glen Rock Comm. Ch. cor. Rock Rd & Hamilton Glen Rock, NJ	Mazziotti Johnson Ad on page 8
17	8:00	Belles & Beaux Margaret 201-384-2791 Rich 201-838-0312	Coleman School 100 Pinelynn Rd. Glen Rock, NJ	Mazziotti Ad on page 25
20	10:00am to 10:30pm	NJ Sq & Rd Dance Conv. Gotta 908-249-2086 Coy 718-238-8825	Trenton State College Rt. 31 Ewing, NJ	Many callers Ad on page 70
23	7:30	Lakeland Squares Carol 201-334-1196 Kathy 201-366-8064	Temple Beth Am 879 S. Beverwyck Rd. Parsippany, NJ	Mitchell Ad on page 45
26	8:00	Circle Eights 201-525-1925 201-387-1135	St. Luke's church cor. Mass. & Grant Haworth, NJ	Woerner Ad on page 33
28	2:00	NNJSDA Graduates Ball Ball 201-838-0312 Berg 201-697-5208	Lincoln Park Comm. Ctr. Rt. 202 & Chapel Hill Rd. Lincoln Park, NJ	Dickinson See ad next issue.

May:

2	8:00	Warren Wheelers McGinley 908-852-0824 Rizzo 908-850-4394	Mansfield School Rt. 57 Port Murray, NJ	Conklin Ad on page 62
---	------	---	---	--------------------------

June

1	8:00	See Saw Squares Lyn & Bob 201-327-9274 Joan 914-353-2987	Old Stone Church 500 E. Saddle River Rd. Upper Saddle River, NJ	Hardy See ad next issue.
---	------	---	---	--------------------------------

SPINNING WHEELS of WAYNE

MAINSTREAM EVERY MONDAY NIGHT - WAYNE CIVIC CENTER - 8:00 to 10:30



- * INTRODUCTION TO PLUS / 8:00 to 8:30
- * THIRD TIP IS PLUS
- * REFRESHMENTS PROVIDED BY MEMBERS
- * WESTERN DANCING WITH DOLORES
- * RAIDERS & MEMBERS - \$2.50
- * GUESTS - \$3.00

CALLER SCHEDULE

JAN	22	Tom Moss		
	29	Dick Pasvolsky		
FEB	5	Bob Robinson	Club Presidents FREE	Presidents Dance
	12	NO DANCE		
	19	NO DANCE		
	26	Don Coy		
MAR	4	Bob Robinson		
	11	Fran Wadel & Bob Kosarek		
	18	Bob Mitchell		St. Patricks' Dance
	25	Pal Johnson		

PLEASE NOTE: *INTRODUCTION TO PLUS* is for ALL SQUARE DANCERS and introduces the *CALLERLAB PLUS PROGRAM*. The caller of the evening will review one plus figure from the previous week and introduce one new figure. Because we dance each Monday night, all plus figures on the callertab list will be presented and then repeated.

OUR PROGRAM GIVES DANCERS PLUS INSTRUCTION FROM MANY CALLERS FOR THE PRICE OF A MAINSTREAM DANCE.

DIRECTIONS

THE WAYNE CIVIC CENTER
Church Lane & Hamburg Tpk
Wayne, NJ

TEMPLE EMAMUEL
Route 202
Oakland, NJ
(Next to Dairy Queen)

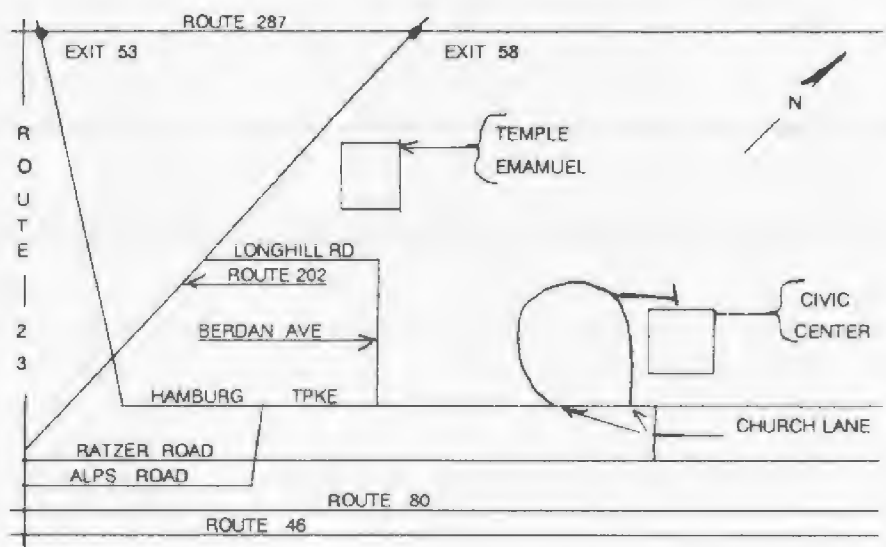

TO THE CIVIC CENTER FROM ROUTE 287 N or S: Take Exit 53 in Pompton Lakes. Turn Right at the bottom of the ramp. Not counting this traffic signal drive 5.5 mi through 12 traffic lights (follow Hospital signs). Immediately after passing through the 12th light turn Right into the Church Lane Jug-Handle, cross over Hamburg Tpke (Civic Center will be on a right diagonal) and turn into the Jug-Handle on the opposite side of Hamburg Tpke. Go 3/4 of the way around this second leg of the Jug-Handle and turn left into the Civic Center parking lot.

TO TEMPLE EMAMUEL FROM ROUTE 287 N or S: Take Exit 58 in Oakland and follow signs for Route 202 South. Go over the Railroad tracks, past a Mobil Gas Station on the right and through the next traffic light. About 1/4 mile on the left is Temple Emanuel, just before the Dairy Queen.

SPINNING WHEELS SQUARE DANCE CLUB * A GREAT PLACE TO DANCE

FOR INFORMATION CALL: DOLORES GESUMARIA (201) 337-8365 or KATHY & HOWIE STEENSTRA (201) 694-2191

VALLEY SQUARES – Warren, NJ

PL/A tip

1 & 3 Thurs. Sept-June Watchung Hills HS, Stirling Road at Mountain Ave

On October 28th, we enjoyed the Rounds' hospitality at Beaver Lake. Duke & Carol pulled out all the stops so we'd have a day of great food and drink, lots of conversation, and even some square dancing (thanks, Len). The sun went down early, but we were inside feasting and playing Boggle. Ron & Roberta Henderson won the prize. Bill & Renee, our Raid Chairmen, arranged our first raid to Cross Trails on October 25th. We are scheduled to visit Hix & Chix on November 30th and Merri Eights on December 15th. There will be more raids to come in the New Year. Try to participate, if you can.

Sunday, November 12th was the Mini-Festival. This was a chance to dance 'til you dropped with Jerry Story, Mike Jacobs, and Mark Franks. Hope you were there for the fun.

Our new location at Watchung Hills High School is working out well. We have lots of room for more dancers, so come on down. You'll be most welcome. Keep dancing.

Ad on page 31

Max & Mary Niederle

908-469-2699

CROSS TRAIL SQUARES

PLUS LEVEL

2nd & 4th Wednesdays 8:00 - 10:30

*Square Dance Workshops: 7:30 - 8:00

** Round Dance Lessons: 7:30 - 8:00

Dancing at Lincoln School
Crane Street, Caldwell, N.J.

INFO: SOMMER (201) 857-1370

MEADOR (201) 256-5414

RAID: NIOSI (201) 482-5811



Jan. 24	Brian Fugere	Pizza Night
	Nick Raspa	Rounds
Feb. 14	Bob Mitchell	Valentine Dance
	Donna Anderson	Rounds
Feb. 28	John Kaltenthaler	Snow Melt
	Nick Raspa	Rounds
Mar. 13	Bob Mitchell	St. Patrick's
	Peg Dockry	Rounds
Mar. 27	Dick Mazziotti	March Madness
	Nick Raspa	Rounds



Dear Readers continued from page 32

most upsetting experience is during distribution when a dancer wants an issue for himself or herself but **won't** take the bundle for the club.

After a while you begin to wonder why we spend hundreds of hours working on each issue? Our families and friends think we are crazy to give up so much of our time, and for free. We know why we do it. **It is called "commitment."** We made a commitment and we have honored that commitment for nearly six years, and so has our wonderful staff. We will continue to honor that commitment because **Grand Square** would die if we quit tomorrow, and we care about square

Please turn to page 50

WARREN WHEELERS -- Port Murray, NJ **MS/PL tips**
1 & 3 Thurs. Sept-June **Mansfield Twnshp Sch, Pt. Murray Rd & Rt. 57**

Several of us joined in a demo with the family of Herb Conklin at Big Brothers and Sisters Farm Show. It was outside on a blustery October day, but it was a lot of fun and for a good cause. Herb called.

A dozen of us demoed at the Care Center of Lopatcong with dancers from Eastonairres. Our audience was very appreciative. Dalt Young called. We also had a dozen members at the NNJSDA Mini-Festival. A fun time was had by all.

Don't let the winter months stop you from dancing. Fun and fellowship chase away the winter blahs. We hope you all had a happy holiday season and wish you much joy and happy dancing in this New Year. Come join us for Mainstream dancing with Plus tips.

Ad on page 62

Joe & Mary Alice McGinley

908-852-0824

FREEDOM VALLEY FROLIC

A Booster Ball sponsored by the Federation of Delaware Valley
 Square and Round Dancers

800-892-8828

\$5.00/person

Sun., Mar. 3, 1996 - Nottingham Ballroom

Rounds

Plus 2x2 2:30-4:00

Squares

Rich & Alison Lock

Pre-Rounds 1:30



Bill Harrison

Tom & Karen Denniston

A-2 Tip 4:30

Mark Franks

WESTERN WHEELERS -- Oradell, NJ

PL/A-1 tips

2 & 4 Sat. Sept-June **Refrmd Ch of Oradell, 641 Church St (cor. Kinderkamack)**

Upon reviewing our W/W membership roster, we're very happy to see that nearly everyone renewed their membership. In addition, we're extremely proud to welcome Don & Fern Walker, John & Connie Huettemann, and Roger & Maria Hoernlein as our newest member couples. These lovely, friendly couples can only add joy to our dancing and fellowship. On the down side, we'll miss the Magens, who will be moving South. May they find a beautiful new life and a great place to continue square dancing. Congratulations to Leon & Gloria Smith on their 50th Wedding Anniversary. I know they must have danced at the Fountain of Youth.

On W/W Halloween Fun Night, Dot Coy made her entrance as a snappy, red-headed flapper, accompanied by Don as her Dapper Dan. Nick Raspa was a regal Marc Antony, while Carole was a dashing ring master (can't say mistress!). Anna Lou Bechmann artistically painted her face to go with her leopard outfit and Jerry was Jungle Jim. Gus Bachmann was a song & dance man and I was a witch (was, not is!). Although one of the worst rain and wind storms was going on outside our Western Night, Mickey McFarland brought sunshine to our dance hall. She delighted us with a variety of entertainment, including her little Q.T. (adorable dog), interesting Plus tips, and her He-He, She-She pantomime. What a warm, friendly caller. She'll make any group smile and have fun!

W/W has altered our A after-tips to reinforce the moves being taught in the A class sponsored by Motiv8ors. Come dance with us. We're still that "friendly club."

Ad on page 14

Marilyn & Gus Bachmann

201-261-3921

Everybody knows how to say no, but it takes judgement to know when.

45th NATIONAL SQUARE DANCE CONVENTION®
SAN ANTONIO, TEXAS, JUNE 26 - 29, 1996



**"CROSS TRAIL THRU
TEXAS WELCOMES YOU"**



NEED: Registration Forms, Tour/Special Event Info??
CONTACT: Bill & Patti Lawson
9401 Cliffbrook Dr., Austin, TX 78747-9503
PHONE/FAX: (512) 243-1534

Y SQUARES -- Clark, NJ

MS

2 & 4 Fri. Sept-May

Carl Kumpf School, Mildred Terr.

Well, the Holidays are over and we hope they weren't too hectic for everyone. Y Squares enjoyed an Octoberfest dance and the usual Halloween party. Special guests Dolly Parton and Willie Nelson were on hand, along with witches, vampires, clowns, scarecrows, and pumpkins. Those who were not in costume confused the caller by wearing black and orange.

In November we had Hero Night. We had a nice crowd who enjoyed a large delicious hero sandwich. We also collected food for the families in Clark. Our November 24th dance provided good exercise after Thanksgiving dinner and leftovers. Our Holiday dance was fun and we collected toys for the children of Clark.

Besides the regular dances we have had the pleasure of raiding other Mainstream clubs. It's fun meeting new friends and dancing with old friends. Don't forget we love having visitors so come join us on the dance floor.

Ad on page 12

Jean Koenig

908-276-8049

SQUARE

-VIEW



BY
MANNY AMOR

"WOW - WHAT A GREAT NEW BASIC"



Tired of elastic sleeves that pull up each time you swing? Tina Petroulas of Rutgers' Promenaders called to our attention a great sleeve she found in Lee McCormick's Square Dance Designs (p. 39). Since Tina has some experience with it, I will paraphrase both she and Lee. Lee calls it "free-and-easy and dressy", which it certainly is.

Look through your street dress patterns and find a regular short sleeve. It should be 3" larger around the bottom than your upper arm measurement at the fullest point, and the bottom should fall about 3-4" above the elbow (the finished

oversleeve will be about 3" longer.) Select a pattern that has only a few gathers at the shoulder. This will be the lining pattern.

To make an oversleeve pattern, trace the lining onto newspaper; draw lines 3" from both underarm seamlines and curve the bottom down to 5" (fig #1.) The underarm seam of the oversleeve should be 3" longer than the lining.

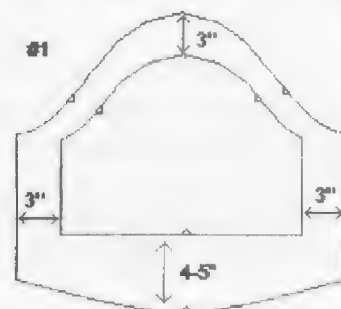

"Puff" is determined by the oversleeve cap: the higher the top of the sleeve cap is raised, the puffier it will be. The minimum added height is 3". Lastly, on the original pattern measure from the notches to the underarm seamline at the front and back, and mark them in the same positions on the oversleeve. Mark the center top and bottom of both patterns.

The lining can be made out of any lightweight fabric, especially if the fashion fabric is either heavy or expensive. Then apply trim if you like; add eyelet, lace, or whatever trim matches your skirt. Remember that the bottom of the oversleeve will fold up several inches inside.

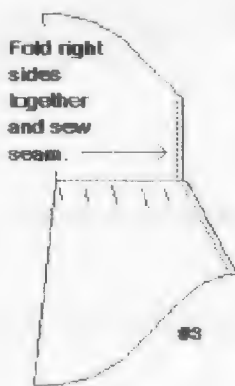
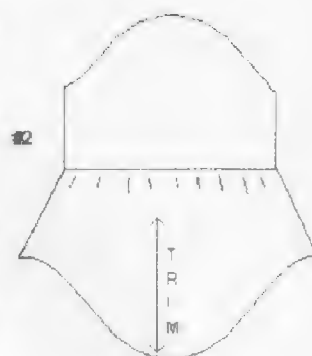

Run gathering stitches close to the bottom edge of the oversleeve. Matching center notches with right sides facing, sew the two bottom edges together (fig #2.)

Open out, re-fold with right sides together, and sew the full length of the underarm seam (fig #3.) Run gathering rows around the top of the oversleeve and, with wrong sides together, baste it to the lining, matching notches and underarm seams. With only a little easing, the sleeve will fit into the armseye. Finish the garment as usual.

Tina comments that you may need a pocket in the skirt that goes with this top--there is no elastic to hold a tissue!! She also passed on some advice she picked up from professional pattern drafter Fan Burris at a recent convention: If the underarm of a bodice is raised by about 1", the waistline will pull up less when the arms are raised. She says it takes a little getting used to, because it fits closer under the arm than we are used to in street clothes, but is very comfortable when dancing.

On another subject: When asked about sergers, I always say to look for differential feed, 4 threads, and easy width and tension controls; that should cost \$3-400, and anything else is a nice extra. I never thought to mention knife blades, because that is how I define a serger: an overlock that trims as it sews. Then I saw a "serger" for \$70±; wow!! So I took a closer look: three threads--but no knife blades. After you trim the seam to 3/8", it uses an edge guide to sew along the edge. How does that differ from what most sewing machines can do? The sewing machine does it as well, and only needs 2 threads instead of 3. This one will be a collectable some day.

LIBERTY STARS

PRESENTS

OUR ANNUAL SPECIAL AT

NOTTINGHAM BALLROOM

MERCER STREET, HAMILTON SQUARE, NJ

WOOD FLOOR - AIR CONDITIONED - 35 SQUARE LIMIT

SUNDAY MARCH 17, 1996
5TH ANNUAL "SALUTE TO AMERICA"

STEVE KOPMAN [Knoxville, TN] on squares
JOHN MARSHALL [HERNDON, VA] on squares
RICH/ALISON LOCK [Norwood, PA] on rounds

2x2 Open Plus 1:30 to 4:15pm; DBD & A-2 tips 4:15 to 4:30pm

\$11:00 per couple, \$5.50 per single in advance through March 15th. \$12.00 / couple, \$6.00 / single thereafter.

Tickets available at the door only if advanced sale does not sell out the dance. Please call to determine availability of tickets or to reserve yours. You may also send for advanced tickets by submitting a check payable to Liberty Stars and self addressed stamped envelope to

Liberty Stars 96 Spring Special,
317 Dalton Street, Phila., PA.
19111-1802

Info: call Ed at (215) 722-7663 or Alan & Deseree (215) 766-7498 or Dick & Ann (215) 698-7258 or Dave & Joyce (610) 664-3993

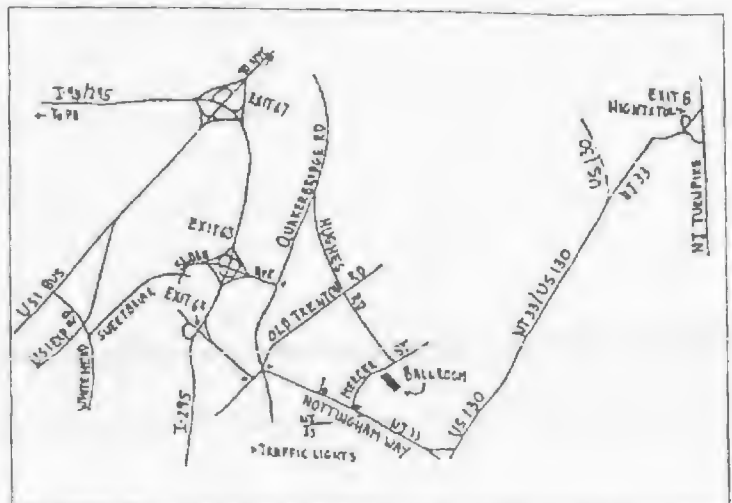

Following is an article from a club that is not currently an *NJSDA* member. . .

M & M SQUARES – Park Ridge, NJ

Basic

1st Saturdays

Pascack Reformed Church, Pascack Rd

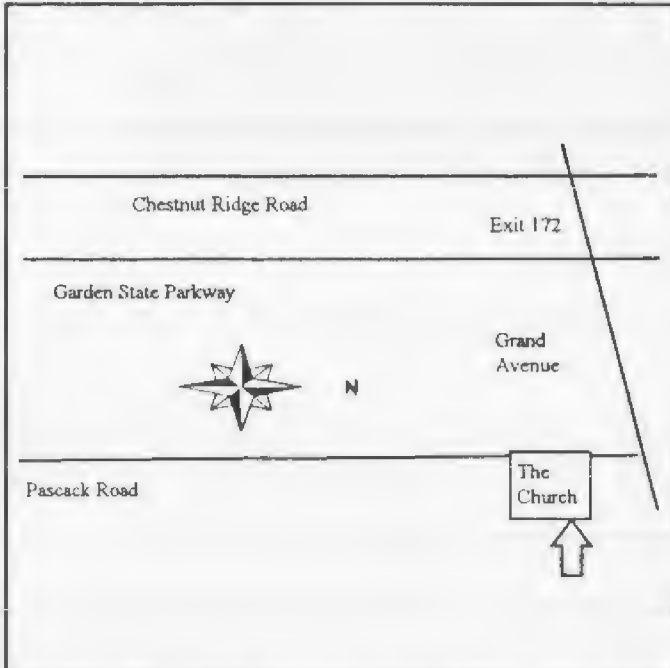

Yes! In this time of declining dancers population, Dick & Laurie Mazziotti announce the formation of a new club, M & M Squares. We offer high level dancing at the Callerlab BASIC Program! Many dancers do not even know there is a Basic Program, but it consists of the first 54 calls from the Mainstream list.

We will be dancing first Saturdays of each month until May, and maybe into the summer if dancers want to continue. Our dances each year will start in December at student-level until everyone has had all the Basic calls. We'll stay there then while other student dances and clubs go into

Mainstream. We intend to prove that Basic can be fun and challenging, and we invite all dancers to bring their budding new dancers to M & M Squares. Try it, you might even like it yourself.

Ad on page 35

Dick & Laurie Mazziotti

201-664-4482

1st & 3rd SUNDAYS
MAINSTREAM 7:00-9:30pm
WITH PLUS TIPS
AND WESTERN DANCING

OUR NEW LOCATION

PARAMUS CONGREGATIONAL CHURCH
 205 SPRING VALLEY ROAD
 PARAMUS, NEW JERSEY 07652
 (201) 261-4166

WINTER -1996

- JAN 21 - PAL JOHNSON
- FEB 4 - STORMY WEATHER DANCE - WEAR WINTER CLOTHES - LOEWENSTEIN
- FEB 18 - DICK PASVOLSKY
- MAR 3 - DOT LOEWENSTEIN
- MAR 17 - ST. PATRICK'S DAY - WEAR GREEN DICK MAZZIOTTI
- APR 7 - NO DANCE - EASTER



**PLEASE:
 SOFT SOLE
 SHOES**

FOR INFORMATION CALL:
 DOROTHY: (201) 447-4964
 BRENDA/DICK: (201) 529-3372
 DOT: (201) 797-1934

**"PROPER SQUARE
 DANCE ATTIRE
 PLEASE"**

Never speak words you would not want to be told you spoke.

LAKELAND'S

TEMPLE BETH AM, 879 SOUTH BEVERWYCK ROAD, PARSIPPANY
 MAINSTREAM WITH 1 PLUS TIP EVERY TUESDAY 8:00-10:30 P.M.
 ROUNDS & LINES WILL START AT 7:30 ON SCHEDULED NIGHT

*Al & Gale Spinks Cue Rounds — 1st and 4th Dance of each month.
 Lois Bichler teaches Western/Line Dances - 3rd & 5th Tuesday*

January 1996

- 2 Bob Mitchell - *Al/Gale Spinks*
Let's Keep Partying (Bring your party hat)
- 9 Herb Conklin
Light Up The Winter (Bring a flashlight)
- 16 Bob Mitchell
- 23 Dick Pasvolsky - *Al/Gale Spinks*
- 30 Fran Wadel - *Student Dance*

February 1996

- 6 Bob Mitchell - *Al/Gale Spinks*
- 13 Len Afinsen
(Valentine's Day Dance)
- 20 Bob Mitchell
(Student Dance)
- 27 Dick Pasvolsky - *Al/Gale Spinks*
(Leap Year Dance)

March 1996

- 5 Bob Mitchell - *Al/Gale Spinks*
Location will be announced (Call for Info:)
- 12 Dan Koft - *Kathy Koft (Rounds)*
(St. Patrick's Soup Dance)
- 19 Bob Mitchell - *Lois Bichler*
(Student Dance)
- 26 Dick Pasvolsky - *Al/Gale Spinks*

April 1996

- 2 Bob Mitchell
(Take me out to the ballpark nite)
- 9 Don Coy, N.Y. - *Dot Coy (Lines)*
(Dance at Parsippany Methodist Church)
- 16 Bob Mitchell - *Lois Bichler*
(Dance at Parsippany Methodist Church)
- 23 Pal Johnson
(Graduation & Student Dance)
- 30 Hank Lutchin, Pa. - *Lois Bichler*

Info: Carol 201-334-1196 • Kathy 201-366-8064 • Gail & Butch 201-335-1693

ETIQUETTE, THE UNMENTIONABLE

by Dick Mazziotti, Caller/Teacher

New Dancers! Welcome to the wonderful, wacky world of square dancing. This column is only for you new dancers. Many more experienced dancers are forbidden by their religion or their doctor from reading this column.

In December, you are all invited to start escaping from classes to join dancers at "student" or "class-level" dances. Here are some of the things concerning those dances that your class was told while you were in the bathroom!

As soon as the music starts, it is time for you to start. Grab your partner and square up **in the first available open square**. In order to avoid familial fisticuffs, now is the time to work out with your partner which one of you gives in when you each square up in two different squares!

Note also that **at your home club**, you and your other club dancers have an obligation to square up with visitors to make them welcome and fill out the squares.

As any instructor or mental health professional will tell you, avoid dancing all night with the same people. Following this advice will soon have you dancing better and you'll not get a reputation as a dance snob. For all dancers, one of the delights of square dancing is the new friends you make. I urge you to get into as many different squares as possible. Try it . . . you'll like it . . . and become a better dancer.

It's the Law! If there is an open spot in a square that's forming, it is open to everyone on the floor. There is no such thing as, "You can't dance here. We already have a square." You don't have a square until all four positions are filled. Refusing someone a position in your square because you are saving it

Please turn to page 46

Mazziotti Column continued from page 45

for someone else will earn you special mention in this column and dirty looks from Laurie. If a special tip is pre-announced, like a hot hash or a Plus tip at a Mainstream dance, then, and only then, if you have a group that would like to try it together, can you walk onto the floor as a square. Otherwise, smile and dance the best you can in every square you're in.

As we get older, we get more and more used to our own habits. . . and aromas. A shower before a dance, use of your favorite deodorant, and clean fresh clothes go without saying--so I won't even mention it.

For women who wear short skirts, and men who wear short shorts, pettipants are a must. There are actually one or two dancers who are known for flashing their tushes to all and sundry. They would dress more appropriately if they know how much they are giggled at.

Once in a square, of course, nothing short of a national emergency of illness is reason to leave it until the tip is over.

Once the music starts, listen closely to the caller and try to do all the calls . . . in the order they are called. There are very few optional calls in square dancing. One aid to continued success in this area is the practice of "closification." Closification (from the Latin: clositus, clasificare) means keeping the square tight and small so excursions are limited. At caller's schools we learn the formula: One part nervous = 3 steps declosification . . . leading to far-apartism and, ultimately, break-downitis.

Having had you labor this far, most all of the above can be summed by repeating our motto here at camp: **SMILE, HAVE FUN, ENJOY!** Happy dancing new dancers. We look forward to seeing you on the dance floor.

Kings' Squares

Brooklyn's First Square Dance Club

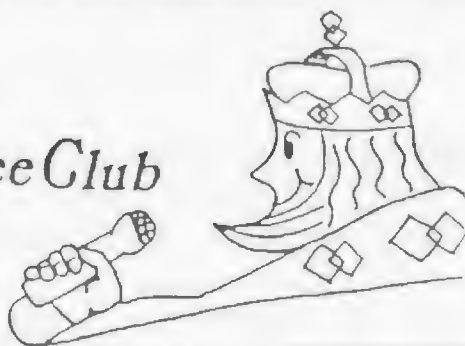

1st & 3rd Sundays

7:30 - 10:00 P.M.

1996

February 4	Dan Kost	Valentine's Day
February 18	Don Coy	President's Day
March 3	Dick Pasvolsky	Cookie Night
March 17	Mickey McFarland	St. Patrick's Day
April 7 - No Dance	Easter Sunday	Happy Easter

For further information: **Jim Hamilton 718-836-3848**
Pat & Bernie Monsen 718-745-3616

REDEEMER-ST. JOHN LUTHERAN CHURCH 939 - 83rd Street, Brooklyn, NY

DIRECTIONS: Belt Parkway to Exit (Bay 8 St/24th Ave.) Left at light - left at next light to 7th Avenue to 83rd St. - right on 83rd Street. Church is on left near next corner.

FROM VERRAZANO: 92nd Street Exit - right to 7th Avenue - left on 7th Avenue to 83rd Street - Right on 83rd Street. Church is on left near corner.



HIX & CHIX

VFW HALL
6 Veterans Pl. Elmwood Park
(Off Boulevard; behind Firehouse)

PLUS PROGRAM - 2nd, 4th & 5th Thursday

ROUNDS TEACH at 7:30 P.M.; SQUARE UP at 8 P.M.
Dance till 10:30 P.M.

RAID HIX & CHIX with advance notice - pay member's fee,
(excluding Specials).

info: John & Connie
(201) 438-0948

Brenda & Dick
(201) 529-3372

	1996	FEBRUARY & MARCH	1996
Feb. 8th -	Len Anfinson		Nick Raspa
22nd -	Dan Koft		Kathy Koft
Mar. 14th -	Howard Richman		Nick Raspa
28th -	Sandy Corey		Regina Wagenhoffer

FEBRUARY 29th ----SADIE HAWKINS DANCE! Guest caller.

SUNDAY, MARCH 10th -----ANNUAL DINNER DANCE

The Brownstone Inn; Paterson, New Jersey

CALLER: John Kaltenthaler

CUER: The Raspas

Advance Reservations - **ALL ARE WELCOME!**



Northern New Jersey Round Dance Leaders Council

We would be more than just remiss, but downright negligent, were we not to put in writing the warm feelings shared by dancers and leaders who enjoyed the very successful Fall Festival of Rounds this past November.

Dave & Wendy Roberts more than met the challenge and obviously accomplished a difficult task programming a complete line-up of Classics that offered a real challenge and pleasant dancing for all. It was obvious that many do need to review and dance these well-written Classics more often. We commend Dave & Wendy for their fine choice of program as well as wisdom in their programming choices. The only let-down of this fine afternoon of dancing was learning that Karen Kushla, suffering from laryngitis, would be unable to cue.

Our newest, aspiring cuer made her debut at the Round Dance Festival. Julie Anne Koft, attended by her parents, graciously greeted all between winks. This one is a real knockout, sure to steal more than just her Daddy's heart.

A real treat was in the offering as Mary Pickett, a protégé of Frank Valenta, made her cueing debut. The resounding applause verbalized the enjoyment of those who danced and listened to Mary's very pleasant voice. If you missed her, we insist you come to the Spring Festival of Rounds, currently being planned for the first Sunday in March, and dance to her.

A sign of spring right around the corner is the New Jersey State Convention. This is the 10th Anniversary of this wonderful event. Many of your leaders and dancing comrades have been putting a great deal of work and effort into bringing you an even bigger and better Convention this year. Remember, it can't work without your support and that's little to ask with a return that is so high. Once

Please turn to page 49

30th NATIONAL ADVANCED AND CHALLENGE SQUARE DANCE CONVENTION

JUNE 20, 21, 22, 1996



PAVILION CONVENTION CENTER
VIRGINIA BEACH, VIRGINIA



STAFF CALLERS:

ED FOOTE PITTSBURGH, PA	DAVE HODSON DAYTON, OHIO	ROSS HOWELL EUSTACE, TX	MIKE JACOBS HERNOON, VA
LEE KOPMAN LONG ISLAND, N.Y.	STEVE KOPMAN KNOXVILLE, TN	DAVE LIGHTLY WAUKEE, IOWA	
BEN RUBRIGHT LOS ALAMITOS, CA	ANNE UEBELACKER VANCOUVER, CANADA	DAVE WILSON LARGO, FL	

ASSOCIATE CALLERS: SAUNDRA BRYANT, VIC CEDER, TODD FELLEGY
NORM POISSON, JOHN SYBALSKY

FIVE HALLS OF AIR CONDITIONED DANCING CONTINUOUSLY

ADVANCED (A-2), C-1, C-2, C-3A, C-3B

(ALSO PART-TIME C-4 BASIC & C-4)

CONVENTION DANCING: THURSDAY AFTERNOON & THURSDAY NIGHT, JUNE 20
MORNING --- AFTERNOON --- EVENING DANCING ON FRIDAY & SATURDAY, JUNE 21 & 22

SPECIAL TRAIL-END DANCE WED. NITE, JUNE 19 ALL HALLS IN OPERATION CONDUCTED BY STAFF CALLERS	SPECIAL NON-STAFF CALLER DANCE THURS. MORNING, JUNE 20 ALL HALLS IN OPERATION
---	---



VIRGINIA BEACH, VIRGINIA



- Numerous sightseeing attractions, including Colonial Williamsburg, Busch Gardens Theme Park, Jamestown Settlement Historic Park, Yorktown Battlefield & Victory Center, Virginia Marine Science Museum
- Air Travelers: Convention Center is 20 minute drive from Norfolk Airport
(Two hotels within walking distance of Convention Center)
- Information on motels, hotels, campgrounds and sightseeing sent when you register.

ARRIVE EARLY - STAY AFTER CONVENTION - FOR A SUPER VACATION EXPERIENCE!

FOR TICKETS, CUT OFF AND MAIL



NAME _____

ADDRESS _____

Check hall you will be dancing
in the majority of the time.

_____ A-2	_____ C-3A	GS
_____ C-1	_____ C-3B	
_____ C-2	_____ C-4 BASIC	
_____ C-4		

DANCE FEE: \$36/PERSON
DEPOSIT: \$10/PERSON
(After May 1, Send Full Payment)

MAIL TO:
ED & MARILYN FOOTE
140 McCANDLESS DRIVE
WEXFORD, PA 15090

Canadian checks and money orders must be in US dollars payable
on a US bank. Canadian postal money orders in US dollars are OK.

NNJRDLC continued from page 47

again Phase V and Phase VI dancers are asked to register early and note their comfortable dancing program. If enough pre-register prior to the programming cutoff date, it will warrant programming some time in a separate hall for a teach and great dancing.

Ad on page 7

Nick & Carole Raspa

201-896-1891

MASQUERADERS SQUARE & ROUND DANCE CLUB

		CALLER	CUER
Jan. 19	Snow Dance	Roy Leber	Tom Denniston
Feb. 02		Al Kaesler	Dave Roberts
Feb. 16	Valentine's	Dan Koft	Kathy Koft
Mar 01		Al Kaesler	Tom Denniston
Mar 15	St. Patrick's Day	Will Larsen	Tom Denniston

Plus Level Squares 8:00 to 10:30 pm Pre rounds 7:30 pm

AMERICAN CZECHOSLOVAK CLUB, Hankins Road, East Windsor, NJ. Just off Route 130. Four lights south of Route 571 (Princeton-Hightstown Road) or two lights north of the junction of Routes 130 and 33. For more information, please call: 609-395-0925.

Round Dance Clubs . . .

GET A ROUNDS - North Brunswick, NJ

Mondays (no 5th)

American Legion, Linwood Pl.

Julie Anne Koft made her debut on October 12th a little ahead of schedule.

No dances January 29 or February 19. Call for further info. Roy: 908-249-2086

Ad on page 56

Roy Gotta & Kathy Koft

Kathy: 908-329-8507

PRINCETON ROUNDS -- Lawrenceville, NJ

Tuesdays

Lawrenceville Firehouse, Rt. 206

We've been dancing the fall away with Autumn Leaves. . . maybe we'll get the dance down before the leaves are down! Then we've stolen a few evenings with Bandito Cha. That one has a few fast steps that should be outlawed! But through it all, Ron & Ree Rumble keep US from falling down with good honest teaching and dancing. Tuesday night is the time to join us on our continuing adventures in round dancing. Be sure to call first if the weather is "iffy."

Cornell & Doris Rockel

609-587-5194

RAMAPO RHYTHMAIRES -- Rutherford, NJ

Mondays

Annunciation Ukrainian Church, Home Ave.

Predicted by Dave & Wendy's all-Classic program enjoyed at the Fall Festival of Rounds, we were besieged with requests to learn many of these fine dances that seemed to be tricky and troublesome. The path of mastering has been paved with much patience and laughter provided by the diversity of these well-written dances. Reinforcement of steps that have been introduced is key, as well as a bonus, as they adventure into the learning of the Classic.

Nick & Carole Raspa

201-896-1891

28th Connecticut Square & Round Dance Festival

Sunday, March 17, 1996; 1:00-8:00 PM

Middletown, CT

Contact: Hank Katten, Publicity Chairmen

205 West Walk, West Haven, CT 06516; Tel: 203-933-7705

1996 NNJSDA SUMMER DANCE PROGRAM

Roselle Park, NJ:	Wednesday, July 10 Joe Landi & Lois Bichler	MS/PL tip/CW
	Wednesday, July 17 Dan Koft & Karen Kushla	MS/PL tip
Lincoln Park, NJ:	Saturday, July 27 Summer Super Blow Out Mark Franks	Alt MS/PL; A-1 tip
Paramus, NJ:	Wednesday, August 7 Randy Page & Burt Schain	MS/PL tip/CW
	Wednesday, August 14 John Kaltenthaler & Nick Raspa	MS/PL tip
	Wednesday, August 21 Don Coy & Dot Loewenstein	MS/PL tip/CW
Lincoln Park, NJ	Saturday, August 31 Summer Super Blow Out Red Bates	Alt. MS/PL/A-1 tip

STATEN SQUARE SET

FEB. 17



MARDI GRAS
w/ **STEVE FORMAN**

MARCH 2

DICK PASVOLSKY

MARCH 16**



ST. PATRICK'S DANCE
w/ **MANNY AMOR**

**BECAUSE OF EASTER AND THE NJ CONVENTION,
WE WILL NOT BE DANCING IN APRIL.**

**** LOIS BICHLER DOES COUNTRY WESTERN**

St. Albans Church Hall
76 St. Albans Pl. Staten Is. N.Y.

Plus Program
8:00 - 11:00 pm

Hochuli's 718 984-8770

Emma's 718 356-1251

Dear Readers continued from page 39

dancing. We hope that through **Grand Square** the lines of communication and dialogue remain open. Take advantage of **Grand Square** and all the help the NNJSDA offers you to keep your club going.

We forget that we have to be a part of an activity in order to really enjoy it. Instead of stepping forward and saying, "We would like to volunteer to help," they look to fade into the wallpaper. Commitment is a dirty word. Heaven forbid we should make a commitment and honor it. There is no magic potion to save a club or square dancing, only careful planning and hard work by all of us will change the down curve. As the title of a well known book suggests: **"Just Do It!"**

Kathy & Charlie Porter, Editors

MERRI-EIGHTS

North Brunswick, NJ
 Plus Dancing
 1st & 3rd Fridays



OUR NEW LOCATION . . .

AMERICAN LEGION POST 459
 1015 Linwood Place, North Brunswick, NJ
 (same hall as Rutgers Promeanders)

Jan.	19	Dan Koft	Kathy Koft
Feb.	2	Dan Koft	Kathy Koft
Feb	16	Joe Landi	Tom Denniston
Mar.	1	Dan Koft	Kathy Koft
Mar.	15	John Kaltenthaler	Mary Ann Bosze
Apr.	5	No Dance	
Apr.	19	Dan Koft	Kathy Koft
Info:	Dave & Wendy Loss		908-752-1046
	Bernie Koft		908-821-9178
	Barry & Evelyn Williams		908-828-2026

This is the second in a series of articles by NNJRDLG members about becoming a cuer. . .

WHY DO I KEEP DOING IT???

by Roy Gotta

The Northern New Jersey Round Dance Leaders Council asked me to write an article on why I became a round dance cuer (hoping to attract others to do the same). That's easy. Back in 1978, Rutgers Promenaders wanted to learn some round dances, Betsy had calling equipment, and no one else in the club knew how to round dance. Viola, instant cuer!

Rather than talk about why I started, I would like to talk about why I continue. Is it a lot of work? Yes. Do I make a lot of money? No. Do I make some extra money? Yes. Do I enjoy doing it? Most of the time. Is it rewarding? Yes! Does it feed my ego? Yes.

If you look at the above paragraph, you will see that most of the responses are yes. The one negative response only refers to the lots of money question. Bottom line? I'm having a great time. I love music of all types; I love performing; and I love teaching. Cueing offers me a chance to experience all of these (and get paid to do it). I often receive favorable comments on my music selections. In all honesty, I choose records because I love working with them. People ask me how I can cue with such enthusiasm (and animation) when there might only be 3 or 4 couples on the floor. Two reasons. The first is that even if there is only one couple, they have paid for and deserve my best performance. The second is that I am performing for myself. I am having a blast. It's kind of like singing and dancing (or playing air guitar) to the radio when you are all alone. I choose music that gets me pumped up, and then give it my best shot. I am doing something that is giving me enjoyment. If the response from the floor (large or small crowd)

Please turn to page 52

NEWS FROM THE 10TH NJ CONVENTION COMMITTEE



Convention Chairs Don & Dot Coy have announced that they have been successful in arranging for a **LIVE MUSIC HALL** for this 10th Anniversary Convention. Programming Chair Randy Page is busily contacting callers for that special requirement, and to provide the very best of calling entertainment. Randy has suggested that the Convention is a great place to dance to a large number of callers with an eye to booking them for future dates at your club.

Roy Gotta, in charge of Registration, has indicated that the number of registrants are already ahead of last year. Fees are \$12 per person as of January 1, 1996 through February 28, 1996 and \$15 after February 28 and at the door.

Dick & Laurie Mazziotti, Publicity Chairmen, 10th NJS&RDC (201-664-4482)



Ocean Waves Square Dance Club
 c/o Christ United Methodist Church
 1890 Forest Ave.
 Staten Island, NY 10303

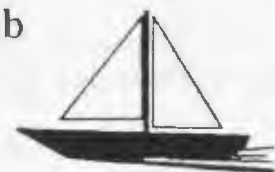

First & Third Fridays
8:30 to 11:00 PM
Mainstream (+ Tip)

<u>DATE</u>	<u>CALLER</u>	<u>WESTERN/LINE</u>
1996		
January 19	Dick Mazziotti	?
February 2	Don Coy	Dot Coy
February 16	Andy Woerner	?
March 1	Don Coy	Dot Coy
March 15	Jim Emory	Deanne Emory
April	No Dances	

Contact Jim & Barbara Thoma 718-948-3056

Why Do I Keep Doing It? continued from page 51

is favorable, then the enjoyment becomes satisfaction. Compliments are icing on the cake.

Are there any down side to cueing? Of course. Sometimes I will really like a dance, but most of the responses are, "Use that record for a coaster." Or, sometimes I'll spend a whole night teaching a figure, and the next week it's as if I only dreamed that I taught that figure. Occasionally, I'll have a bad night and foul up every other dance. I'm constantly buying new records (anybody want to buy several hundred slightly used records?). But the up side far outweighs the down side.

To sum why I keep cueing, I will relate what another cuer told me several years ago. This person said that they never thought of being a cuer until they say how much fun I appeared to be having.

The Rutgers Promenaders

1995/96 Dance Schedule

January	25		Dan & Koft	
February	8		Betsy Gotta	
	22	Presidents Dance		
		Chinese Auction	Betsy Gotta	
March	14	International Night	Betsy Gotta	
	28		Dan Koft	
April	11		Betsy Gotta	
	25	Pot Luck dinner	Betsy Gotta & Dan Koft	
May	9		Dan Koft	
	23		Dan Koft & Betsy Gotta	

Program: Mainstream
Location: American Legion Post 459
 1015 Linwood Place, North Brunswick NJ
Time: 8-10:30 PM
Date: 2nd & 4th Thursdays
Squares: Betsy Gotta & Dan Koft
Rounds: Roy Gotta with Betsy & Kathy Koft with Dan
Contacts: Ray Schmidt: 908-613-9505
 Jeff Platenia: 908-249-0916

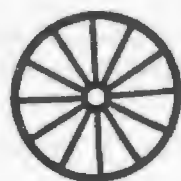

Directions: Take RT.1 to the Georges Rd. New Brunswick Exit (from the north, keep to the right; from south come back across Rt. 1 and keep to left). At the first intersection turn left onto Cranbury Cross Rd. At the four-way stop, turn left onto Linwood Place. The hall is on the right, just before the end of the road.



PARADIGMS IN OUR SQUARE DANCE ACTIVITY

Legacy, the International Assembly of "Trustees" of the Square Dance Activity, in conjunction with the National Square Dance Convention, presented two one-hour sessions each day at the June NSDC in Birmingham, AL. A number Legacy trustees served as moderators and panelists at these daily sessions.

Much has been said and written about the changes that have been, and are, occurring within the square dance activity. Using the quote that "Dance, to survive, cannot remain unchanged, and like any living thing, it must either develop or disappear," the first session concentrated on why the picture has changed, and the need to look beyond certain stereotyped ideas or boundaries that are possibly keeping some positive changes from being made. It was noted that modern technology has made major changes in callers' and cuers' equipment, as well as aid for the hearing impaired dancer. Also noted was how the dress code has been modified to include prairie skirts.

A lively but thoughtful and positive discussion occurred as the attendees began to reflect on current practices. Suggested were some brand new approaches to making the square dance activity more marketable, new methods of recruitment with different approaches to conducting classes. They also touched upon different positive approaches they thought the National Executive Committee of the NSDC should try, and ways in which the major organizations could work together. As the group left, all were given a "pair of dimes" to remind them that what seems impossible today could be done tomorrow to enhance the activity and lead us into the 21st century.

The second hour dealt with the topic, "Planning A Year of FUN-filled

Please turn to page 54

Paradigms in our Square Dance Activity continued from page 53

Activities." This session enlarged upon a quote from Sigmund Freud that, "Every human being needs some positive things to look forward to." Reminding all that when events are scheduled and planned with lots of lead time, there is a much better chance that they will be presented well and enjoyed by both dancers AND planners, the moderator and panelists proceeded to discuss the three-page hand-out outlining 18 months of fun-filled activities. Twelve points were offered for the planning of every successful activity. Several times during the audience participation periods, the additional successful ideas and activities described by the attendees came faster than the pen could record.

All agreed that setting and attitude, along with the planning, go a long way to making a good time. Also stressed was the importance of being super-friendly, and really meaning it. Having new members work along with a "seasoned" couple on a fun activity was mentioned as one way to ease new members into becoming actively involved. When the hour was over, participants continued their sharing of ideas in the hallways.

SINGLES IN A COUPLE ACTIVITY

This topic provided a most lively and informative session. A large number of couples, as well as singles, gathered to share experiences and focus on how to accept everybody in our activity. Although the plan was to delve into singles clubs here and abroad, family clubs and "mixed" clubs who accept both single and couple members, the discussion quickly broadened to include the problems of divorced and widowed dancers, youth and young adults who want to dance, gay and lesbian dancers, and couples where only one member was able to dance.

Although the word "solo" was suggested for those without a partner, many felt

Please turn to page 59

HI TAW TWIRLERS

1996 PLUS DANCES - A2 AFTERTIP

NEW MILFORD MIDDLE SCHOOL

ROSLYN AVE., NEW MILFORD, NJ

PUBLIC PHONE: (201) 261-9881

JANUARY

16 RANDY PAGE
30 HOWARD RICHMAN

APRIL

2 BRIAN FUGERE
16 JOHN KALTENTHALER
30 KEN RITUCCI

FEBRUARY

6 JOHN KALTENTHALER
27 ROY LEBER

MAY

7 JOHN KALTENTHALER
21 PHIL KANDRUT

MARCH

5 JOHN KALTENTHALER
19 JIM SNYDER

JUNE

4 JOHN KALTENTHALER

Rounds...7:30 - Cuer: Nick Raspa

Squares...7:45 - 10:00

Info: BERNIE/SANDY (201)447-0538 FRED/MARIAN (201)797-3421



RON LIBBY
Squares

Roaring Brook Weekend

Lake George, NY
April 19-20-21, 1996

*An Exciting
Plus Program
Weekend*



**CURT & TAMMY
WORLOCK**
Rounds

SQUARE & ROUND DANCE

- Six Square Dance Sessions
- Four Round Dance Sessions
- Plus Program Dancing
- Star Tips A1 and A2
- Accommodates 25 Squares (100 couples)
- Al & Mary Hasbrouck Square Dance Apparel Shop

DELUXE ACCOMMODATIONS

- ENTIRE RESORT just for Dancers
- Deluxe rooms—Friday & Saturday nites
- Four complete meals
—Friday and Saturday dinners
—Saturday and Sunday breakfasts
- Continuous Coffee Fri. & Sat. Eves.
- After dance snacks and beverages

FACILITIES

- All rooms have private ceramic baths
- Indoor swimming pool
- Authentic Finnish sauna rooms
- Scenic woodland trails
- Fantastic views • Coffee shop
- Delicious food • Tennis courts
- And much, much more . . .

*You get all these Benefits
for only \$276.00 per couple.
Ask about our
GROUP DISCOUNT.*

Phone or Mail Roaring Brook Weekend
Reservations to: Roaring Brook Ranch
Lake George, NY 12845

1 (800) 882-7665 or (518) 668-5767



Mastercard & VISA accepted or
Make checks payable to Roaring Brook Weekend

RESERVATION FORM

PLEASE PRINT

Name(s) _____

Mailing Address _____

City _____

Province/State _____

Country _____

Postal Code/Zip _____

Phone Number _____

Club Affiliation _____

Adjoining Rooms with _____

if possible

Please indicate your choice
of Dinners & Number:

Friday / Baked Chicken _____ Broiled Fish _____

Saturday / Sirloin _____ Broiled Chicken _____

**All currency MUST be in
U.S. Funds / U.S. Bank
Mastercard & Visa accepted.**

\$50.00 deposit per couple required with this Reservation (refundable up to April 1, 1996). Balance
due on or before April 1, 1996. Weekend cost \$276.00 per couple. (Dining Room Gratuities included.)

GS

**GROUP DISCOUNT: Eight (8) couples registered by a GROUP LEADER at one time before 12/31/95 and
paying the balance in full by 4/1/96 will each receive a \$10.00, per couple, cash refund at check-in time.**



SQUARE DANCE COUNCIL OF NEW JERSEY

At the October 21, 1995 meeting of the SDCNJ, Rich & Georgie Flandera were elected Chairmen; Kathy & Charlie Porter were re-elected Treasurers; and the post of Secretary is vacant.

A donation to St. Agnes Hospice, Lexington, KY, in the amount of \$250 in memory of Jim Howatt. Jim died of melanoma on June 1, 1995. Jim was a well known caller and contra leader and he and Doris were the Chairmen of the 2nd NJ Square & Round Dance Convention.

The "Investment in the Future Committee" was discussed and publicity was requested to make the guidelines known on an annual basis.

INVESTMENT IN THE FUTURE COMMITTEE GUIDELINES

- The Committee must consider any proposal, by accepting, recommending, negotiating or rejecting.
- The type of proposals solicited are:
 - Big regional demo or special, traditional style, to publicize square dancing.
 - Student newsletters
 - Dance-around programs
 - Get well plans for ailing clubs, organizations, etc.
 - Other, as the need arises
- Proposals should be in the form of a "business plan." That means a series of tasks, from conception, costing, tentative rental and professional agreements, to publicity to payback, with broken-down costs, returns and a time-line for each task. There is no better way to make people think things through, and gives them small goals with a short time frame.
- Grants should be disbursed according to each individual task's time frame (not all at one). Reports should be quarterly to the Committee, providing the opportunity for review and any action deemed necessary.

Please turn to page 57

info
908-249-2086

GOTTA DANCE With Roy & Betsy Gotta

You
Gotta
Believe

1st 3rd & 5th Thursdays -BACtracks (A2 w/rounds)

Trinity Episcopal Church, Red Bank, NJ 8:00 pm

2nd & 4th Sundays (mostly) - tagBACs (C1 w/rounds)

ACFC, Hankins Rd., West Windsor, NJ 7:30 pm

2nd & 4th Thursdays - Rutgers Promenaders (MSw/Rnds)

Amer. Legion, No. Brunswick, NJ 8:00 pm (with the Kofts)

Every Monday (no 5ths) - Get A Rounds (Ph 3/4 Rnds)

Amer. Legion, No. Brunswick, NJ 8:00 pm (w/ Kathy Koft)

Occasional Tuesdays - C3A

Amer. Legion, No. Brunswick, NJ 8:00 pm

Guest Appearances -

Jan 19 - Ridge Stompers, Both (Glassboro, NJ); Jan 20 - Independence Sq, Betsy;(Phila)

Jan 26 -Lefooters,Both (Kingston, NY); Feb 9 - Free State Twirlers, Both (DE);

Feb 17 - North Country Sqs., Both (Plattsburg, NY); Feb 23-25 - **Do-Ski-Do**;

Feb 27 - Times Sqs, Betsy; Mar 1 - Pairs & Squares, Betsy (Toms River);

Mar 3 - Spa Wheelers, Both (Scotia, NY); Mar 9 - Chesapeake Sq, Betsy (Balt. MD);

Mar 15 - Single Funtimers, Both (Katonah, NY); Mar 16 - Harmony Dancers, Roy;

**COUNTRY PROMENADERS
PRESENTS**

**TIM MARRINER (GA)
STEVE BRADT**

IN

GARNIVALE
SATURDAY, FEBRUARY 24, 1996

**STEVE'S EARLY ROUNDS: 7:30-8:00
PLUS LEVEL SQUARES 8:00-10:30**

**LET'S
PARTY!**

**COSTUMES
WELCOME!**

**STELTON COMM. CENTER
SEE CLUB FLYER FOR MAP**

**INFO: JAN: 908-577-9413
PAT: 908-819-7483**

Square Dance Council of New Jersey continued from page 56

- Any member of any member organization is eligible to apply to the Committee.
- The Committee must guard against the possibility of using the mechanism to make a big profit. However, reinvestment of good return on capital invested could be a subsequent proposal.
- Some proposals, e.g., student newsletters and dance-around programs, are intended to pay back benefits, not funds.
- It is possible that other proposals, such as get-well plans, although designed to pay back funds, may never actually do so.
- The opportunity to make such proposals should be widely publicized.

Above guidelines approved at the SDCNJ Annual Meeting October 1991.

CALLERLAB QUARTERLY AND EMPHASIS SELECTIONS

Mainstream:

Hinge Over (9/95)

Plus:

Cross Over Circulate (11/95)

Dropped: Split Ping Pong Circulate

Advanced:

Scatter Scoot (5/94)

Dixie Fire (5/95)

Cross the K (9/95)

Dropped: Relay the Top

Mainstream Emphasis

Slide Thru

Plus Emphasis:

Partner Tag

Rockland Promenaders

Mainstream Dancing
Second Sunday of the Month



Featuring
Instructed Western Line Dancing
between Tips

Please Note our
NEW, NEW LOCATION

Less than 2 Miles from GSP Exit 172

Green Meadow Waldorf School

Route 45 at Hungry Hollow Road
Chestnut Ridge, New York
7:30pm - 10:00pm
Soft-Soled Shoes REQUIRED

1996 DANCE SCHEDULE

January	14	Bob Paris
February	11	Dick Mazziotti
March	10	Howard Richman
April	14	John Kaltenthaler
May	12	Dave Hass
*June	9	Ralph Stapenell

* Call for our Air-Conditioned Summer Dance Location
for June, July, & August

For Information, Call: Bob & Sherry (914) 357-7549
 Len & Carol (914) 354-4374
 Jim & Peg (201) 664-4847

Directions: From GSP Northbound Exit 172, turn left at end of ramp onto Grand. At the traffic light turn right onto Chestnut Ridge Road. Green Meadow Waldorf School is less than 2 miles on your left.

From GSP Southbound from the NYS Thruway, exit at Red Schoolhouse Road, turn right at the end of the ramp. When Red Schoolhouse Road meets Route 45 (traffic light), turn left. Green Meadow Waldorf School is less than 1 mile on your right.

Singles in a Couple Activity continued from page 54

the solo ribbon was discriminatory. While singles halls are appreciated, the question was asked why they are usually placed in a far away location. Another question was asked why "hitching post" areas are usually in a remote area of the hall, not near the entrance. Also, if there is a singles hospitality room, could it be nearer the entrance?

Participants told of dancing as solos in Europe and Australia, where they had not experienced the problems encountered in the United States. It was pointed out that the singles problem is not just confined to the square dance activity, but can be found elsewhere, in stores, restaurants, and even churches. By making the square dance world aware of the problem, it can be reduced in our activity. Tolerance is the word, always remembering one panelist's reminder that all couples are just a heartbeat away from being single.

Applying truth in advertising was strongly suggested as being needed. Clubs need to be truthful about partners for single neophytes to the activity. There is also a need to stop selling square dancing as a way to meet a mate. Some come just to dance.

With the dancers in the activity growing older, some far-sighted members are working to encourage youth and younger adults to join square dancing. Most attendees agreed that if the activity is to prosper and grow into the next century, this must be encouraged.

The hour went by all too quickly, with many positive suggestions and a request to convene again next year to come up with positive actions to recommend to Legacy and those who are responsible for conducting conventions. For more information about Legacy, contact Al & Vera Schreiner, 1100 Revere Dr., Oconomowoc, WI 53066 (414- 567-3454).

1st AND 3rd FRIDAYS

7:30 PRE ROUNDS
8:00 PLUS LEVEL



IRONIA REELERS

IRONIA SCHOOL, (RT 513) DOVER
CHESTER ROAD, (IRONIA) RANDOLPH

PIE NIGHT

2/2 ☐ Lou Flego
 ☉ Al Spinks

2/16 ☐ Brian Fugere
 ☉ Al Spinks

3/1 ☐ Joe Landi
 ☉ Al Spinks

WEARING OF THE GREEN

3/15 ☐ Len Anfinsen
 ☉ Al Spinks

LOCATION TO BE ANNOUNCED

3/29 ☐ Marion Pearce
 ☉ Karen Kushla

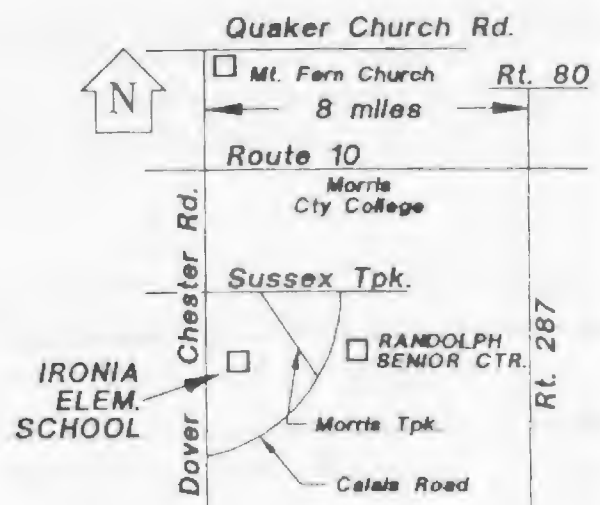

FOR MORE INFORMATION CALL:

MARION AND BILL GRADY (908-879-4920)
OR

JEAN AND INARS GRUNTALS (201-543-7792)



SQUARE DANCERS, ARE YOU READY?

WELL TEXAS IS READY FOR YOU! We have an abundance of square dance halls to meet your needs. What is an abundance you say? Well, let's take a look at what Texas has to offer you.

Located in the Convention Center Complex we have for the Mainstream Program, 42,800 square feet of dancing area and Mainstream with Rounds will have 22,800 square feet (parquet floor) of this footage.

Plus dancers will enjoy 29,800 (parquet floor) square feet. This is also the hall that will have the live band if we can make the arrangements. We don't want to leave out the future of our activity, the youth. What do we have for them? We have 2,400 square feet of space for them to kick back and let it all hang out. If we have Handicapped dancer requests, we have 2,304 square feet of space to accommodate them. Challenge dancers, don't fret you are being left out. What do we have for you? Well let us tell you we have three halls with a total of 10,560 square feet for your dancing enjoyment.

Like what you have read so far? Hang on , there is more to come. Moving west across the street from the Convention Center, we go to LaVillita Center (five-minute walk) where the Advanced Program will have a total of 24,000 square feet of dancing space in two halls. Across the street to the north is the Marriott Hotel where the All Singing Calls hall and the DBD Hall will be located. Each of these halls will have 4,900 square feet of floor space. Just north of the Marriott Hotel is the Marriott River Center Hotel. This will be our Plus with Rounds Hall. Another 19,200 square feet of dance floor.

But wait, we're not through yet. Moving to the east we find the Alamo Dome.

Please turn to page 61

<p>SEE SAW</p>  <p>SQUARES</p>	<p>Old Stone Church Education Center 500 East Saddle River Road Upper Saddle River, NJ</p>
<p align="center">PLUS DANCING ON THE THIRD SATURDAY</p> <p>8:00 All-position PLUS workshop 8:30 PLUS tips alternating with Western dancing with RUTH EDISON 10:30 Class level ADVANCED tips</p>	
<p>Jan. 20 ROY LEBER - Chinese Auction Feb. 17 DAN KOFT - Hawaiian Night Mar. 16 RANDY PAGE - Wearin' of the Green April No Dance - See you at the New Jersey Convention! May 18 STEVE FORMAN - Western Night</p>	
<p>Info: Lyn & Bob 201-327-9274 Joan 914-353-2987</p>	<p>Easy directions: GSP exit 172, west on Grand Ave., north on East Saddle River Road to Weiss Road.</p>

SHIRLEY'S SQUARE DANCE SHOPPE

16-page brochure: "Patterns and Petticoats"

Featuring Square Dance Patterns,
Petticoats in sizes to 3X, lengths to 30"
.. free Pettipants, ..

Specials on some patterns, lace, eyelets,
laces, S/D jewelry, and 2 blouses and skirt.

For brochure, send *\$1.00 payable to:
Shirley's Square Dance Shoppe
Rt. 9-D, Box 423, Dept NE
Hughsonville, NY 12637
914-297-8504

*Club officers: Send \$3.00 postage, and we'll
mail you 8 copies for your class.

Shirley's full line S/D Apparel Shoppe is open
Wed., Thurs., and Sat. 11-4
or anytime by appointment.
We recommend calling ahead
before coming to shop.

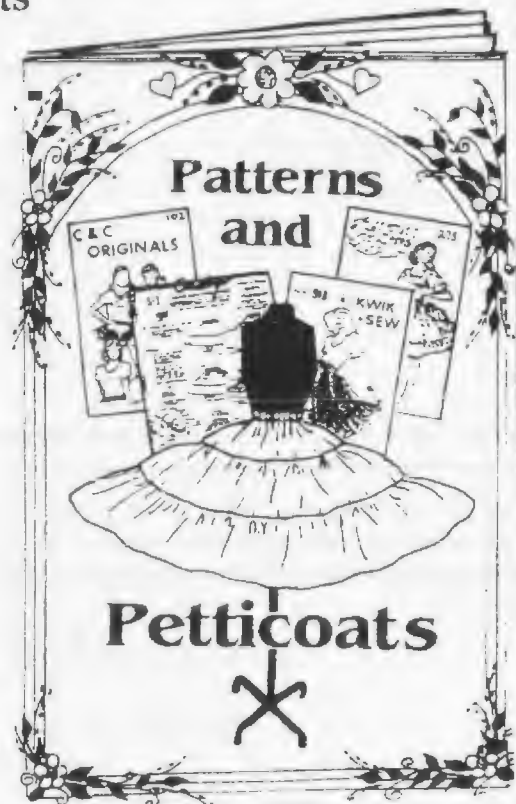

Square Dancers Are You Ready continued from page 60

Would you believe 30,000 square feet at the north end of the main floor for Plus (possibly Mainstream/Plus) dancing. On the south end of the main floor will be the Singles Hall with 30,000 square feet of dance floor.

Yes, dancers, Texas is ready for you with a total of 204,864 square feet of dance floor for your enjoyment. The Square Dance Committee of the 45th National Square Dance Convention extends a special invitation to you to come and enjoy Texas hospitality. Texas is the state; June 26-29, 1996 is the date; San Antonio is the place.

REGISTRATION & HOUSING INFORMATION NEWS

HOTEL CONFIRMATIONS: Hotels to send registrants in the future.

HOTELS FILLED: The Menger, Emily Morgan, Riverwalk Plaza 7 Rodeway Inn-Downtown.

RV-CAMPING: Erroneous report: "The 45th NSDC has all of the camping areas filled." The 45th ONLY HAS THE BROOKS AIR FORCE BASE AREA BOOKED FOR CAMPERS. They have no control over arrangements made by private campgrounds.

RED RIBBONS: "I AM REGISTERED" Red Ribbons are being sent to registrants. Their primary purpose is to advertise the 45th NSDC and will not gain anyone entrance into the Special Event of the Convention facilities for dancing. Please wear them and help us ADVERTISE the 45th.

CONFIRMATION FORM: Registrants will receive this form, notifying them of items purchased, the name of their assigned hotel, registration number along with other general information.

Please turn to page 62

REGISTRATION FORM: All changes to the original registration form must be resubmitted and indicated with "ADDENDUM." If changes are other than name, address, or adding of items, there is a \$5,00 fee per delegate. Note - this is indicated on the front of the form (red rectangular block on front and item No. 7 on the back of form).

EARLY BIRDS:

Thanks to all who purchased "One Star Passes" Early Bird certificates. However, these certificates DO NOT register you. You MUST complete and submit a registration form, even though nothing else is desired, to be registered. When submitting the registration form, REMEMBER, YOU DO NOT SEND IN ANY REGISTRATION MONEY. This was paid when you purchased an Early Bird Certificate. ONLY send in money if you order other items: i.e. program book, cookbook, special event tickets, etc.

WARREN WHEELERS

MANSFIELD TOWNSHIP ELEMENTARY SCHOOL
RT 57, PORT MURRAY, NJ
8:00 TO 10:30



ALTERNATING
MS & PLUS
TIPS

-INFO-

MC GINLEY (908) 852-0824
RIZZO (908) 850-4394
SCHOOL # (908) 689-9856

FEB	1	ED KERNS	
FEB	15	DICK PASVOLSKY	PIE NIGHT
MAR	7	BOB KOZAREK & FRAN WADELL	(2FER)
MAR	21	DICK PASVOLSKY	ST. PATTIES NIGHT
APR	4	DICK PASVOLSKY	SPRING IS HERE!
APR	18	NO DANCE	
MAY	2	HERB CONKLIN	GRADUATION*
MAY	16	DICK PASVOLSKY	
JUN	6	WILSON HOFF	
JUN	20	DICK PASVOLSKY	COVERED DISH (6:30)

* STUDENTS FREE

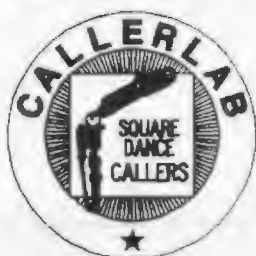

At a recent meeting of the Callerlab Executive Committee, the recommendations of the search committee for an Assistant Executive Director for Callerlab were considered. The final interview was conducted and Jerry Reed of Rockledge, Florida was chosen. We have delayed the announcement of this choice while Jerry completed some pending work and the appointment will become effective at the next Callerlab Convention in Kansas City, Missouri on the first of April.



COME DANCE WITH US!



LEISURE SQUARES

1st and 3rd SATURDAYS

DALT YOUNG Calling Squares

Rounds by: ED MILLER



DANCE HELD AT
J. M. HILL SCHOOL
East Broad Street
East Stroudsburg, PA

SPRING DANCE SCHEDULE 1996

NO DANCES in JAN. & FEB.!!!

MAR	2	PIE BAKERS BALL
	16	ST PATRICKS DANCE
APR	6	APRIL FOOLS DANCE
	20	<u>CANCELLED !!!</u>
MAY	4	ITALIAN FEST
	18	ICE CREAM SOCIAL

Now dancing 8:00 to 10:00 PM
M.S. & Plus & Rounds alternate
Information: 717-897-6784
717-424-9403



LETTERS TO THE EDITORS continued from page 9

will do that, but perhaps with a little more money in the treasury, callers/cuers who will attract a better attendance can be hired.

Which brings us to the topic of caller/cuer fees. In the late '60s and early '70s, good, experienced callers from the area (visiting traveling callers not included) were charging \$45-\$75 for a typical square dance. Today those same callers are charging \$75-\$135 for the same dances. For argument sake, let's say a 100% increase. This is below the cost of dance fee increases and way below typical wage increases for the same period (minimum wage from \$1.50 to \$5.50 per hour, up 267%). A DJ, who does nothing but play records at weddings and parties, is charging \$300 to \$500 for the same amount of time. Also, if you stay at a job for a long time, improve your skills, and become more proficient at your trade, don't you expect to be compensated accordingly with raises?

If a particular caller is out of your budget range, **don't hire him/her!** However, before you write them off, talk to them. You will be surprised how many of them (not all) are willing to work with (percentages, per person, different date to coincide with other plans). After all, the more clubs that fold, the less opportunity there is for them to earn their money.

This article does not offer any easy solutions to keeping the clubs afloat. Hopefully, it has cleared up some misconceptions and will open the door for some meaningful dialogue (perhaps fact-finding committee or L.U.S.T. topic) so that our activity will remain an integral part of New Jersey's recreation picture.

Roy Gotta

For anything worth having one must pay the price;
and the price is always work, patience, love, self-sacrifice.
John Burroughs



Harmony Dancers

Plus Dancing

1st & 3rd Saturdays

8:00 to 10:30
Pre-Rounds 7:30



CHISHOLM SCHOOL, SO. SPRINGFIELD AVE. AT SHUNPIKE, SPRINGFIELD, NJ

Jan. 28 "Round Dance Special" (Tickets Required - See Flyer for details)	Ron Rumble
Feb. 3 "Valentine ♥ Dance" (Advanced Tip @ 10:30)	John Kaltenthaler Al Spinks
Feb. 17 "Presidents' Ball" - Black Tie Optional -	Brian Fugere Steve Bradt
March 2 "Mad Hatter's Dance"	Manny Amor Al Spinks
March 16 "St. Patrick's Dance" (Advanced Tip @ 10:30)	John Kaltenthaler Roy Gotta
May 4 "Drew Scearce Special" - "Rainbow Dance" -	Drew Scearce Steve Bradt
May 18 "Ice Cream Social"	Dan Guinn Steve Bradt

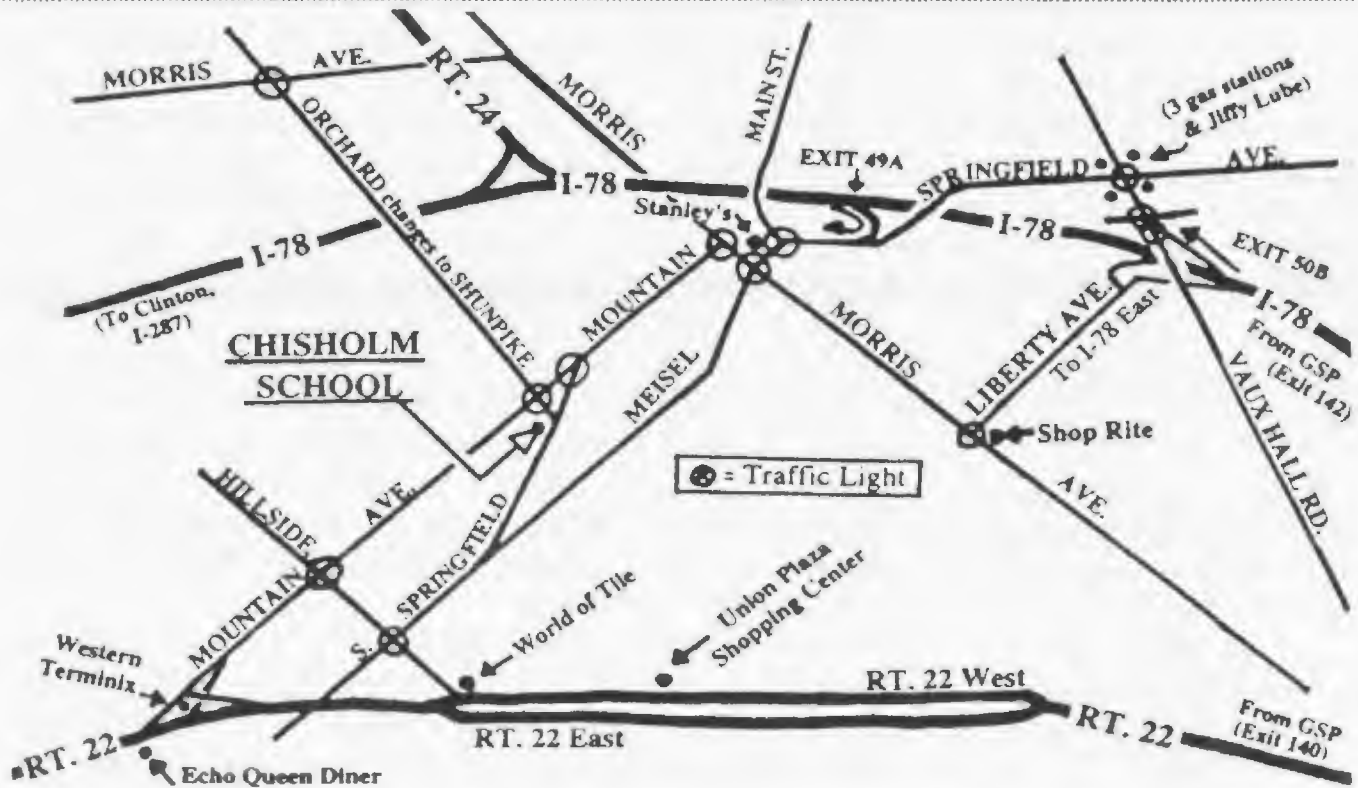

Call: Wayne/Kay Schroeder 908-396-8286
 Corinne/Leo Eckmann 201-379-3901
 Jude/Roger Remington 908-322-1879

Soft Soled Shoes, Please
 Chisholm Hall Phone: 201-376-9822

Dance Calendar

Mid January to March listing of dances, weekends and workshops prepared from ads appearing **IN THIS ISSUE**. Please see ad for details.

Abbr: A=Advanced; Alt=Alternate; C=Challenge; MS=Mainstream; PL=Plus;
TBA=To Be Announced; WS=Workshop; CW=Country & Western

*See caller/cuer ad for details.

Date	Club	Caller/Cuer/Leader	Place	Program
January				
21	F.A.D. Sqs.	Johnson	Paramus, NJ	MS/PL tips/CW
	Kings Sqs.	Martellacci	Brooklyn, NY	PL
	Motiv8ors	Page/Raspa	Paramus, NJ	A-2/C-1 tip
22	Spinning Wheels	Moss/Gesumaria	Wayne, NJ	MS/CW/PL tip
23	Lakeland Sqs.	Pasvolsky/Spinks	Parsippany, NJ	MS/PL tip
24	Cross Trail Sqs.	Fugere/Raspa	Caldwell, NJ	PL
25	Hix & Chix	Hardy/Raspa	Elmwood Park, NJ	PL
	Rutgers Prom.	Koft/Koft	N. Brunswick, NJ	MS
26	Bee Sharps	Pearce/Booz	Somerville, NJ	PL
	Circle Eights	Woerner	Haworth, NJ	Student
	Kittatinny Rangers	Anfinsen	Andover, NJ	MS/PL tip
	Y Squares	Fugere/Kushla	Clark, NJ	MS
27	Country Prom.	Richman/Bradt	Edison, NJ	PL/DBD or A tip
	Richmond Dancers	Koft/Koft	Staten Island, NY	PL
	Western Wheelers	Leber/Raspa	Oradell, NJ	PL/A tip
28	NNJSDA Student Mid-Term	Mazziotti	Lincoln Park, NJ	Student
	Al'e'Mo Sqs.	Woerner	Brooklyn, NY	MS
	Harmony Dancers	Rumbles	Springfield, NJ	Rounds
29	Spinning Wheels	Pasvolsky/Gesumaria	Wayne, NJ	MS/CW/PL tip
30	Hi Taw Twirlers	Richman/Raspa	New Milford, NJ	PL/A-2 tip
	Lakeland Sqs.	Wadel	Parsippany, NJ	Student
31	Mountain Sqs.	Landi	Whippany, NJ	A-1
February				
1	Valley Sqs.	Anfinsen/Raspa	Warren, NJ	PL
	Warren Wheelers	Kerns	Pt. Murray, NJ	Alt MS & PL
2	Hunterdon Flut.	Hoff/Dockery	Stanton, NJ	Alt MS/PL
	Ironia Reelers	Flego/Spinks	Randolph, NJ	PL
	Merri Eights	Koft/Koft	N. Brunswick, NJ	PL
	Ocean Waves	Coy/Coy	Staten Island, NY	MS/PL tips
	Rockytops	Callahan/Raspa	Pearl River, NY	PL/A-1 tip
3	Harmony Dancers	Kaitenthaler/Spinks	Springfield, NJ	PL/A tips
4	F.A.D. Sqs.	Loewenstein	Paramus, NJ	MS/PL tips/Cw
	Kings Sqs.	Koft	Brooklyn, NY	PL
	Motiv8ors	Jacobs/Raspa	Paramus, NJ	A-2
5	Spinning Wheels	Robinson/Gesumaria	Wayne, NJ	MS/CW/PL tip
6	Hi Taw Twirlers	Kaltenthaler/Raspa	New Milford, NJ	PL/A-2 tip
	Lakeland Sqs.	Mitchell/Spinks	Parsippany, NJ	MS/PL tip
7	Belles & Beaux	Mazziotti	Glen Rock NJ	MS/PL tips
	Mountain Sqs.	Landi	Whippany, NJ	A-2
8	Hix & Chix	Anfinsen/Raspa	Elmwood Park, NJ	PL
	Rutgers Prom.	Gotta/Gotta	N. Brunswick, NJ	MS
9	Bee Sharps	Kaesler/Roberts	Somerville, NJ	PL
	Kittatinny Rangers	McFarland/Spinks	Andover, NJ	MS/PL tip
	Tenafly Sqs.	Amor/Raspa	Haworth, NJ	MS
	Y Squares	Fugere/Kushla	Clark, NJ	MS

Continued on page 66

February contd.

10	Country Prom Richmond Dancers Western Wheelers	Fugere/Spinks Koft/Koft Page/Raspa	Cranford, NJ Staten Island, NY Oradell, NJ	PL/DBD or A tip PL PL/A tip
11	Al'e'Mo Sqs. Belles & Beaux Rockland Prom.	Hardy Mazziotti/Johnson Mazziotti	Brooklyn, NY Glen Rock NJ Chestnut Ridge, NY	Student Student MS/CW
13	Lakeland Sqs.	Anfinsen	Parsippany, NJ	MS/PL tip
14	Cross Trail Sqs.	Mitchell/Anderson	Caldwell, NJ	PL
15	Valley Sqs. Warren Wheelers	Kaltenthaler/Tristram Pasvolsky	Warren, NJ Pt. Murray, NJ	PL Alt MS & PL
16	Hunterdon Flut. Ironia Reelers Merri Eights Ocean Waves Tenakill Twirlers	Hoff/Dockery Fugere/Spinks Landi/Denniston Woerner	Stanton, NJ Randolph, NJ N. Brunswick, NJ Staten Island, NY	Alt MS/PL PL PL MS/PL tips
17	Harmony Dancers See Saw Sqs. Staten Sq. Set	Richman/Raspa Fugere/Bradt Koft/Edison Forman	Cresskill, NJ Springfield, NJ Up. Saddle River, NJ Staten Island, NY	MS/PL tip PL/A tips PL/CW/A tips PL
18	F.A.D. Sqs. Kings Sqs.	Pasvolsky Coy	Paramus, NJ Brooklyn, NY	MS/PL tips/CW PL
20	Lakeland Sqs.	Mitchell	Parsippany, NJ	Student
22	Hix & Chix Rutgers Prom.	Koft/Koft Gotta/Gotta	Elmwood Park, NJ N. Brunswick, NJ	PL MS
23	Bee Sharps Circle Eights Kittatinny Rangers Y Squares	Mazziotti/Spinks McFarland Weiner Fugere/Kushla	Somerville, NJ Haworth, NJ TBA Clark, NJ	PL MS MS/PL tip MS
24	Country Prom. Richmond Dancers Western Wheelers	Marriner/Bradt Amor/Kushla Leber/Raspa	Edison, NJ Staten Island, NY Oradell, NJ	PL/DBD or A tip PL PL/A tip
25	Al'e'Mo Sqs. Motiv8ors	Martellacci Crosby/Raspa	Brooklyn, NY Paramus, NJ	MS A-2
26	Spinning Wheels	Coy/Gesumaria	Wayne, NJ	MS/CW/PL tip
27	Hi Taw Twirlers Lakeland Sqs.	Leber/Raspa Pasvolsky/Spinks	New Milford, NJ Parsippany, NJ	PL/A-2 tip MS/PL tip
28	Cross Trail Sqs.	Kaltenthaler/Raspa	Caldwell, NJ	PL
29	Hix & Chix	TBA/Raspa	Elmwood Park, NJ	PL

March

1	Hunterdon Flut. Ironia Reelers Merri Eights Ocean Waves Rockytops	Hoff/Dockery Landi/Spinks Koft/Koft Coy/Coy Franks/Raspa	Stanton, NJ Randolph, NJ N. Brunswick, NJ Staten Island, NY Up. Saddle River, NY	Alt MS/PL PL PL MS/PL tips PL/A-1 tip
2	Harmony Dancers Leisure Sqs. Staten Sq. Set	Amor/Spinks Young/Miller Pasvolsky	Springfield, NJ E. Stroudsburg, PA Staten Island, NY	PL/A tips Alt MS/PL PL
3	F.A.D. Sqs. Kings Sqs. Motiv8ors	Loewenstein Pasvolsky Fellegy/Raspa	Paramus, NJ Brooklyn, NY Paramus, NJ	MS/PL tips/CW PL A-2/C-1 tip
4	Spinning Wheels	Robinson/Gesumaria	Wayne, NJ	MS/CW/PL tip
5	Hi Taw Twirlers Lakeland Sqs.	Kaltenthaler/Raspa Mitchell/Spinks	New Milford, NJ TBA	PL/A-2 tip MS/PL tip
6	Belles & Beaux Mountain Sqs.	Loewenstein/Martellacci Landi	Glen Rock NJ Whippany, NJ	MS/PL tips A-2

Continued on page 67

March contd.

7	Valley Sqs. Warren Wheelers	Hanks/Koft Kozarek/Wadel	Warren, NJ Pt. Murray, NJ	PL Alt MS & PL
8	Bee Sharps Kittatinny Rangers Tenafly Sqs. Y Squares	Young/Roberts McFarland Coy Fugere/Kushla	Somerville, NJ Andover, NJ Haworth, NJ Clark, NJ	PL Student Student MS
9	Country Prom. Richmond Dancers Western Wheelers	Snyder/Bradt Anfinsen/Koft Mazziotti/Raspa	Edison, NJ Staten Island, NY Oradell, NJ	PL/DBD or A tip PL PL/A tip
10	Belles & Beaux Hix & Chix Rockland Prom.	Mazziotti/Coy Kaltenthaler/Raspa Richman	Glen Rock NJ Paterson, NJ Chestnut Ridge, NY	Student PL MS/CW
11	Spinning Wheels	Wadel/Kozarek	Wayne, NJ	MS/CW/PL tip
12	Dingman Dancers Lakeland Sqs.	Murphy Koft/Koft	Milford, PA Parsippany, NJ	MS/PL tip MS/PL tip
13	Cross Trail Sqs.	Mitchell/Dockery	Caldwell, NJ	PL
14	Hix & Chix Rutgers Prom.	Richman/Raspa Gotta/Gotta	Elmwood Park, NJ N. Brunswick, NJ	PL MS
15	Hunterdon Flut. Ironia Reelers Merri Eights Ocean Waves Tenakill Twirlers	Hoff/Dockery Anfinsen/Spinks Kaltenthaler/Bosze Emory/Emory Coy/Raspa	Stanton, NJ Randolph, NJ N. Brunswick, NJ Staten Island, NY Cresskill, NJ	Alt MS/PL PL PL MS/PL tips MS/PL tip
16	Harmony Dancers Leisure Sqs. See Saw Sqs. Staten Sq. Set	Kaltenthaler/Gotta Young/Miller Page/Edison Amor/Bichler	Springfield, NJ E. Stroudsburg, PA Up. Saddle River, NJ Staten Island, NY	PL/A tips Alt MS/PL PL/CW/A tips PL
17	F.A.D. Sqs. Kings Sqs. Motiv8ors	Mazziotti McFarland Leber/Raspa	Paramus, NJ Brooklyn, NY Paramus, NJ	MS/PL tips/CW PL A-2/C-1 tip
18	Spinning Wheels	Mitchell/Gesumaria	Wayne, NJ	MS/CW/PL tip
19	Hi Taw Twirlers Lakeland Sqs.	Snyder/Raspa Mitchell/Bichler	New Milford, NJ Parsippany, NJ	PL/A-2 tip Student
20	Belles & Beaux Mountain Sqs.	Mazziotti Landi	Glen Rock NJ Whippany, NJ	MS/PL tips A-2
21	Valley Sqs. Warren Wheelers	Hanks/Kushla Pasvolsky	Warren, NJ Pt. Murray, NJ	PL Alt MS & PL
22	Bee Sharps Circle Eights Kittatinny Rangers	Snyder/Raspa Coy Murphy	Somerville, NJ Haworth, NJ TBA	PL MS MS/PL tip
23	Country Prom. Richmond Dancers Western Wheelers	Kalthenthaler/Bradt Pasvolsky/Kushla Leber/Raspa	Edison, NJ Staten Island, NY Oradell, NJ	PL/DBD or A tip PL PL/A tip
24	Kittatinny Rangers	2 callers/Spinks	Budd Lake, NJ	Alt MS/PL
25	Spinning Wheels	Johnson/Gesumaria	Wayne, NJ	MS/CW/PL tip
26	Dingman Dancers Lakeland Sqs.	Murphy Pasvolsky/Spinks	Milford, PA Parsippany, NJ	MS/PL tip MS/PL tip
27	Cross Trail Sqs.	Mazziotti/Raspa	Caldwell, NJ	PL
28	Hix & Chix Rutgers Prom.	Corey/Wagenhoffer Koft/Koft	Elmwood Park, NJ N. Brunswick, NJ	PL MS
29	Hunterdon Flut. Ironia Reelers	Hoff/Dockery Pearce/Kushla	Stanton, NJ TBA	Alt MS/PL PL
30	Motiv8ors	Jedicka/Raspa	Paramus, NJ	A-2

Continued on page 68

Non NNISDA Clubs:

January:

20	*Independence Sqs.	Gotta	Philadelphia, PA
26	*Lefooters	Gotta/Gotta	Kingston, NY

February

2	Masqueraders	Kaesler/Roberts	E. Windsor, NJ	PL
3	M & M Sqs.	Mazziotti	Park Ridge, NJ	Basic
9	*Free State Twirlers	Gotta/Gotta	Delaware	
10	Sat. Nite Live	Woerner	Bergenfield, NJ	Student
16	Masqueraders	Koft/Koft	E. Windsor, NJ	PL
17	*N. Country Sqs.	Gotta/Gotta	Plattsburg, NY	
27	*Times Sqs.	Gotta	New York, NY	

March

1	Masqueraders	Kaesler/Denniston	E. Windsor, NJ	PL
	*Pairs & Sqs.	Gotta	Toms River	
2	M & M Sqs.	Mazziotti	Park Ridge, NJ	Basic
3	*Spa Wheelers	Gotta/Gotta	Scotia, NY	
9	*Chesapeake Sqs.	Gotta	Baltimore, MD	
	Sat. Nite Live	Woerner	Bergenfield, NJ	Student
15	Masqueraders	Larsen/Denniston	E. Windsor, NJ	PL
	*Single Funtimers	Gotta/Gotta	Katonah, NY	
17	Liberty Stars	2 callers/Lock	Philadelphia, PA	PL/A-2 tips

Weekends, Festivals, Specials & Conventions:

February

4	Bucks-Trenton Dist.	Callahan/Rumble	Hamilton Sq, NJ	PL/A-2 tip
23-25	*Do-Ski-Do	Kaltenthalers/Gottas	Pocono Mts, PA	
25	CCNJ Spring Dance	Many Callers	Glen Rock, NJ	Student

March

3	Freedom Val Frolic	2 callers/2 cuers	Hamilton Sq, NJ	PL/A-2 tip
	Spring Festival Rds.	Many cuers	Elmwood Park, NJ	All Phases

April

18-20	Myrtle Beach Ball	3 callers/Whetsell	Myrtle Beach, SC	All Programs
19-21	Roaring Brook Wknd	Libby/Worlock	Lake George, NY	PL/A tips
20	10th NJ S&R Convention	Many callers/ cuers/leaders	Trenton State, Ewing, NJ	All Programs

May

3-5	Birchwood Wknd	Loewenstein/Martellacci	E. Stroudsburg, PA	
10-11	Intl. S&R Conv.	6 callers/2 cuers	Ontario, Canada	All Programs
11	Belles & Beaux	Mystery Bus Raid	???	???

June

20-22	Natl. A&C Conv.	15 callers	Virginia Beach, VA	A-2 to C-4
-------	-----------------	------------	--------------------	------------

September

11-14	Myrtle Beach Ball	5 callers/2 cuers	Myrtle Beach, SC	All Programs
-------	-------------------	-------------------	------------------	--------------

ATTENTION STUDENT DANCERS
See the pages 36 & 37
for a list of Class-level dances.

DIRECTIONS & MAP FOR THE FOLLOWING NNJSDA DANCES:

MID-TERM CLASS-LEVEL DANCE - SUNDAY, JANUARY 28, 1996
(see ad on page 3)

SPECIAL PLUS DANCE - SATURDAY, MARCH 30, 1996
(see ad on page 5)

AT LINCOLN PARK COMMUNITY CENTER
Route 202 (Main St) & Chapel Hill Road
Lincoln Park, NJ

GARDEN STATE PARKWAY NORTH - EXIT 153B - RT. 46 WEST: Take Route 46 West to Route 23 North/Butler. Immediately get into slow lane - Exit - 202 South /Lincoln Park (Alt 511). Make a Left off the ramp. Take Rt. 202 South / Alt. 511 thru 4 Lights. (Street signs say Boonton Tpk.) At 4th light, (intersection of Route 202 and Chapel Hill Road) go through the light and make a Left at the Library. The Community Center is to the Right. Make a Left to go behind the Library for additional parking.

GARDEN STATE PARKWAY SOUTH - EXIT 154 - RT. 46 WEST / CLIFTON: Follow directions above ❶.

ROUTE 23 NORTH - EXIT ROUTE 202 SOUTH / LINCOLN PARK. Make a Left off the ramp. Follow directions under GSP North ❶.

ROUTE 23 SOUTH - EXIT ROUTE 202 SOUTH / LINCOLN PARK. Off the ramp at the first light (Mountain View Blvd.) make a left onto Route 202/Alt 511. Continue 3 more lights. Follow directions under GSP North ❶.

ROUTE 80 WEST - EXIT 53 - ROUTE 23 NORTH - BUTLER: Follow directions under GSP North ❶.

ROUTE 80 EAST - EXIT 47B - ROUTE 46 EAST. Proceed on Route 46 to Lincoln Park / Two Bridges Road Exit. Make a Left off the ramp to go over Route 46. Follow directions below under Route 46 West ❷.

ROUTE 46 WEST - EXIT - LINCOLN PARK / TWO BRIDGES ROAD: (1st exit beyond Willowbrook Mall). Right onto Passaic Ave. Take Passaic Ave. to the bridge. Cross bridge and turn Left. Follow Two Bridges Road which becomes Chapel Hill Road to just before Route 202. Make a Left into the Municipal Building Driveway which takes you behind the Library and Firehouse.

ROUTE 46 EAST - EXIT - LINCOLN PARK / TWO BRIDGES ROAD: Make a Left off the ramp and go over Route 46 (Passaic Avenue). Take Passaic Avenue to the bridge and follow directions above ❷.

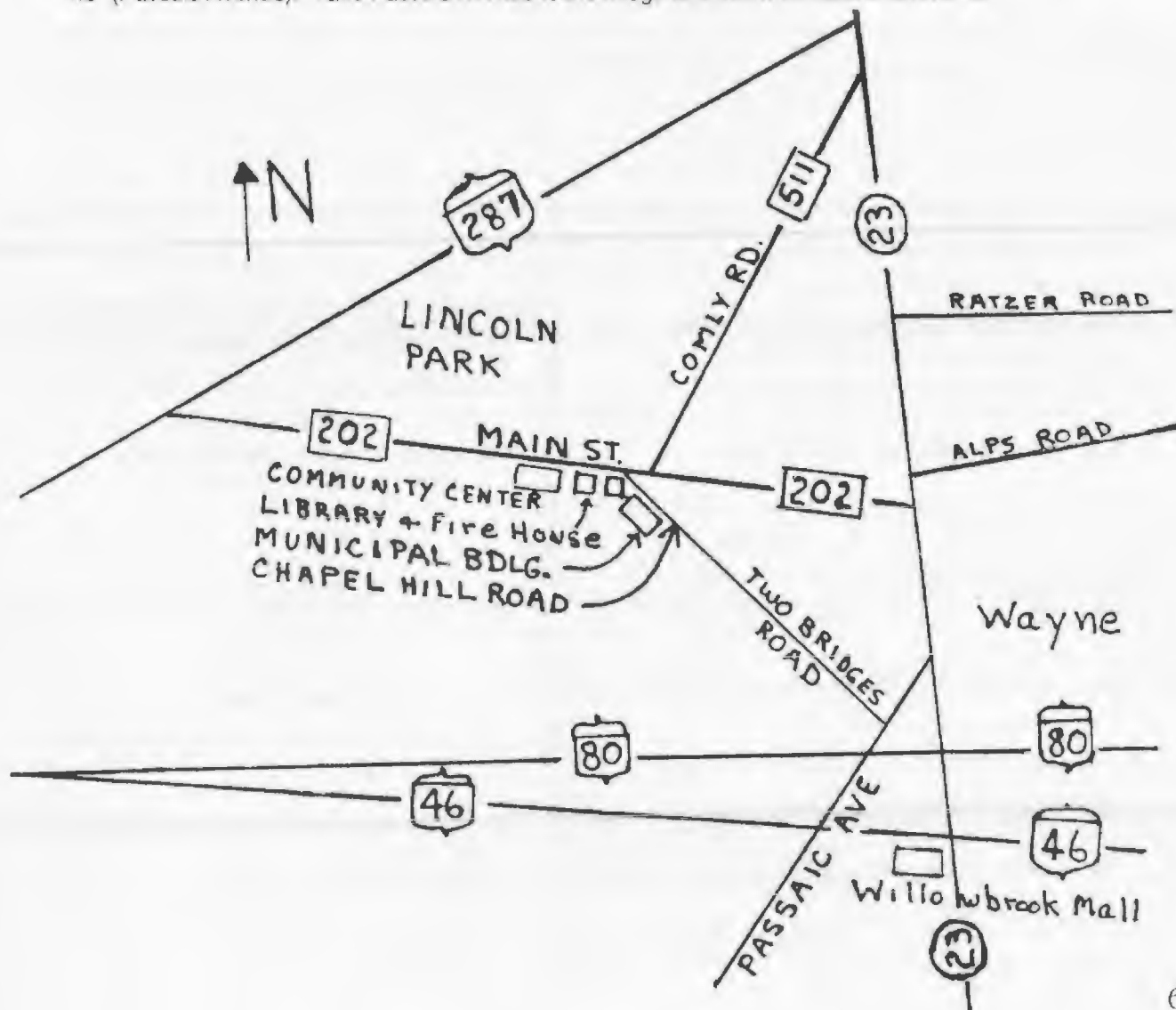

The 10th New Jersey Square & Round Dance Convention



Saturday
April 20, 1996
10:00 am to 10:30 pm
 Trenton State College
 Ewing, NJ



Presented by The Square Dance Council of New Jersey

Fees per PERSON
 \$10 thru December 31, 1995
 \$12 January 1, 1996 thru February 28, 1996
 \$15 After Feb. 28, 1996 and at the door

For More Information Call:
 (908) 249-2086 Roy & Betsy Gotta
 (718) 238-8825 Don & Dot Coy

Cancellation Fee - \$2. No refund after March 1, 1996. Proper square dance attire is required for convention activities. *NO* taping at the convention. Directions and advanced information will be sent with confirmation near the end of February.

Detach Bottom Portion & Mail to:
 SDCNJ, P. O. Box 7598, North Brunswick, NJ 08902-7598
 Make Checks Payable to SDCNJ

Last Name _____ First Name(s) _____
 Others _____
 Street _____ Town _____
 State _____ Zip _____ - _____ Phone (____) _____ Amt. Encl. \$ _____

<p>*DANCER QUESTIONS*</p> <p><i>Please Read and check all that apply</i></p> <p>_____ I/We would like to <i>volunteer 1 hour of time</i> to help on the day of the convention.</p> <p>_____ I/We need information on RV Parking</p> <p>_____ I/We need information on Local Motels</p> <p>I/We dance the following programs (check <i>ALL</i> that apply)</p> <table border="0"> <tr> <td>Squares</td> <td>Rounds</td> </tr> <tr> <td>_____ Approaching Mainstream</td> <td>_____ Phases I & II</td> </tr> <tr> <td>_____ Mainstream</td> <td>_____ Phases III & IV</td> </tr> <tr> <td>_____ Plus</td> <td>_____ Phases V & VI</td> </tr> <tr> <td>_____ A1</td> <td></td> </tr> <tr> <td>_____ A2</td> <td>Other _____ Clogging _____ Folk Dance</td> </tr> <tr> <td>_____ C-1</td> <td>_____ Contra _____ CW/Line</td> </tr> </table> <p>**Number of Previous NJ Conventions Attended <input type="checkbox"/></p>		Squares	Rounds	_____ Approaching Mainstream	_____ Phases I & II	_____ Mainstream	_____ Phases III & IV	_____ Plus	_____ Phases V & VI	_____ A1		_____ A2	Other _____ Clogging _____ Folk Dance	_____ C-1	_____ Contra _____ CW/Line	<p>Did you attend last year's Conv.? Yes ___ No ___</p> <p>Is the above Regis. Info the same as last year? Yes ___ No ___</p>
Squares	Rounds															
_____ Approaching Mainstream	_____ Phases I & II															
_____ Mainstream	_____ Phases III & IV															
_____ Plus	_____ Phases V & VI															
_____ A1																
_____ A2	Other _____ Clogging _____ Folk Dance															
_____ C-1	_____ Contra _____ CW/Line															
<p><i>To be filled in by Callers, Cuers, Clogging Instructors & Demo Group Leaders Only</i></p> <p>Please Check ALL areas where you wish to be programmed</p> <p>_____ Squares</p> <p>_____ Rounds</p> <p>_____ Contra</p> <p>_____ Folk Dance</p> <p>_____ Clogging</p> <p>_____ Line Dancing</p> <p>_____ Country Western</p> <p>_____ Demo Group</p> <p>Leaders MUST register by <i>January 1, 1996</i> to be scheduled. Questionnaires will be mailed upon receipt of this form.</p>																

NEW THIS YEAR:
LIVE MUSIC HALL!!

IN THIS ISSUE . . .

Be A NJ Conv. Diplomat	11	New Year Greetings	4
Callerlab	57, 62	NJS&RD Convention	52
Club Ad Makers Info	18	NNJRDLC	47, 51
Coming Next Issue	31	NNJSDA Calendar	4
Cross Trail Thru TX	41, 60	NNJSDA Info Tel #	2
CT S&R Dance Fest	49	NNJSDA Summer Dances	50
Dance Calendar	65	Non Member Club News	44
Dear Readers	32	Presidents' Letter	3
Did It Really Happen?	22	RD Club News Begins	49
Directions to NNJ Dances	69	Sewing Circle Squared	42
Help Wanted	24	Sq Dance Council of NJ	56
In Memoriam-Dell'Angelo	7	Sq Dance 800 Tel #	2
Legacy	53	Sq Dance License Plates	33
Letters to the Editors	8, 9, 19	Square View	41
Mazziotti Column	45	Student Dance Calendar	36
Member Club News Begins	10	USA West SD Conv	27
New England Convention	34	Why Do I Keep Doing It?	51

You Don't Have to Climb a Mountain to Find Good Advanced Dancing!

MOUNTAIN SQUARES

First Presbyterian Church, 494 Route 10 W., Whippany, NJ
 Level A-2 1st and 3rd Wednesdays 7:45 - 10:15 PM

A-1 SPECIAL JAN 31 JOE LANDI, CALLER

Upcoming A-2 Dances: Feb. 7, Mar 6 & 20, Apr 3 & 17

Information: Groth (201) 746-0656 or Sly (201) 391-0248



ADVERTISERS' INDEX

Please tell our advertisers that you saw their ad in *Grand Square*.

Al'e'Mo Sqs	16	Hix & Chix	47	NSDC	41
Bee Sharps	19	Hunterdon Flut	22	Ocean Waves	52
Belles & Beaux	25	Intl. S&R Conv	30	Roaring Brook Wknd	55
B & B Mystery Bus	29	Ironia Reelers	59	Richmond Dancers	20
B & B Student	8	K's Advanced Wksp	17	Rockland Prom	58
Birchwood Wknd	27	Kings Sqs	46	Rockytops	11
Bolos & Petticoats	13	Kittatinny Rangers	36	Rutgers Prom	53
Bucks-Trenton Dist.	32	Kitt. Hawaiian Luau	21	Rutg. Chinese Auc	24
CCNJ Spring Dance	9	Lakeland Sqs	45	Sat Nite Live	37
Circle Eights	33	Leisure Sqs	63	See Saw Sqs	60
Country Prom	26	Liberty Stars	43	Shirley's SD Shop	61
CP Carnivale	57	M&M Sqs	35	Spinning Wheels	38
Cross Trail Sqs	39	Masqueraders	49	Sq Dance Videos	23
Dahl House	32	Merri Eights	51	Staten Sq Set	50
Dingman Dancers	18	Motiv8ors	34	Tenafly Sqs	15
F.A.D. Sqs	44	Mountain Sqs.	71	Tenakill Twrlrs	10
Freed Val Frolic	40	Myrtle Beach Balls	28	Valley Sqs	31
Gotta Dance	56	Natl. A&C Conv	48	Warren Wheelers	62
Harmony Dncrs	64	NJ Convention	70	Western Wheelers	14
Hi Taw Twirlers	54	NNJRDLC Spring Fest	7	Y Squares	12
		NNJSDA	-3, 4, 5, 6, 24, 69		

NNJSDA MEMBER CLUBS

See club articles (alphabetically Z-A) and ads for further information. Advertisers Index appears on inside back cover. Clubs desiring to change dance night or location

MUST contact the Recording Secretary (listed on page 2) for Clearance.

Abbr: A=Advanced; Alt=Alternate; CW=Country & Western; MS=Mainstream; PL=Plus.

MAINSTREAM

	Weeks of the Month:
Sunday:	
Al'e'Mo Sqs	2, 4 Sept-Jun
F.A.D. Sqs.	1, 3 Sept-Jun
Rockland Prom.	2 All Year
Monday:	
Spinning Whls	Every Wk. Sept-Jun 2, 4 Jul-Aug
Tuesday:	
Belles & Beaux	2, 4 Jun-Aug
Dingman Dncrs	2, 4, 5 Mar-Dec
Lakeland Sqs	Every Wk Sept-Jul
Wednesday:	
Belles & Beaux	1, 3 Sept-May
Thursday:	
Rutgers Prom.	2, 4 Sept-May
Warren Whlrs.	1, 3 Sept-Jun
Friday:	
Circle Eights	4 Sept-Jun
Hunterdon Flutterwh	1, 3 Sept-Jun
Kittatinny Rangers	2, 4 Sept-Jun
Ocean Waves	1, 3 Sept-Jun
Tenafly Sqs.	2 Sept-Jun
Tenakill Twirlers	3 Oct-May
Y Squares	2, 4 Sept-Jun
Saturday:	
Leisure Sqs.	1, 3 Oct-Dec & Mar-May

PLUS

	Weeks of the Month:
Sunday:	
Kings Sqs.	1, 3 Sept-Jun
Tuesday:	
Hi Taw Twirlers	1,3, 5 Sept-Jun
Wednesday:	
Cross Trail Sqs.	2, 4 Sept-Jun
Thursday:	
Hix & Chix	2, 4, 5 Sept-Apr Every Wk May-Aug
Valley Sqs.	1, 3 Sept-Jun
Friday:	
Bee Sharps	2, 4 Sept-Jun
Hunterdon Flutterwh.	1, 3 Sept-Jun
Ironia Reelers	1, 3 Sept-Jun
Merri Eights	1, 3 Sept-May
Rockytops	1 Oct-Jun
Saturday:	
Country Prom.	2, 4 Sept-May
Harmony Dancers	1, 3 Sept-May
Leisure Sqs	1, 3 Oct-Dec & Mar-May
Richmond Dancers	2, 4 Sept-Jun
See Saw Sqs.	3 Sept-Jun
Staten Square Set	1, 3 Oct-Jun
Western Whlrs.	2, 4 Sept-Jun

ADVANCED

Sunday: Motiv8ors (A-2) 1, 3 some 5 Sept-Jun Every Jul-Aug	Wednesday: Mountain Sqs. (A-2) 1, 3 Sept-Jun
---	--

DANCES CANCELLED

February: 12 - Spinning Wheels 14 - Mountain Sqs. 18 - Motiv8ors 19 - Spinning Wheels 21 - Belles & Beaux Mountain Sqs.	April: 5 - Hunterdon Flut. 6 - Merri Eights M & M Sqs. 7 - F.A.D. Sqs. Kings Sqs.	April contd. 18 - Warren Whlrs. 20 - All Clubs
--	---	---

Dingman Dancers & Leisure Squares are not dancing in January & February.
 Harmony Dancers, Ocean Waves, & Staten Square Set are not dancing in April.
 Princeton Squares has suspended dancing.

*The Editors of **Grand Square** reserve the right to edit, correct, or otherwise modify articles or ad copy submitted for publication. Signed articles and letters are the opinions of the authors and not necessarily those of the NNJSDA.*